

Club dei
Riparatori

Club dei
Riparatori



THE COMPANY



Club dei Riparatori

**THE WINNING SOLUTION
TO MANUFACTURE
AND REPAIR ALL KINDS
OF PRESSURE WASHERS**

www.sparesclub.com



*"To change in time".
It is one of the reasons
of our success.*

Who we are

Since 1997 Club dei Riparatori by Idrobase manufactures spare parts and accessories to service all kinds of h.p. washers.

Club dei Riparatori breaks the monopoly of manufacturers in the market for h.p. washers parts. Now, the repairer of h.p. washers can choose between buying from the usual suppliers or from Club dei Riparatori; in this way he reduces sales prices and delivery times, while increasing quality of services.

Mission of Club dei Riparatori states:
"To supply all that you need to service any kind of h.p. washer in the world!"

*Always original
in presenting
our solutions*



Our business

Our products are of the highest quality and our prices are generally 30% lower than those of our competitors. Our costs are the lowest in the market simply because we do not rely on intermediaries and everything is arranged direct.



Chiara BALLARIN

chiara@idrobase.com
skypeidro16
+39 049 9335908
+39 049 9335922



Pamela CALLEGARO

pamela@sparesclub.com
skypeidro10
+39 049 9335908
+39 049 9335922



Matthew DUNN

matthew@idrobase.com
skypeidro13
+39 049 9335908
+39 049 9335922



Erika SCAPIN

erika@sparesclub.com
skypeidro11
+39 049 9335908
+39 049 9335922



Tatiana TELYASHOVA

tatiana@idrobase.com
ICQ: 479387104
skypeidro05
+39 049 9335908
+39 049 9335922

HIGH PRESSURE WASHERS
DOLLY Spare Parts® - pump spare parts

HIGH PRESSURE WASHERS
Accessories and Components

CLEANING MACHINE
Accessories and spare parts

<i>Subject</i>	<i>Page</i>
Dolly fitting Annovi Reverberi:	
• <i>Table pump search</i>	90
• <i>126 (HPE) series</i>	91
• <i>132 (XT) series</i>	92
• <i>178 (XM) series</i>	94
• <i>194 (XW) series</i>	96
• <i>298 (RW) series</i>	97
• <i>228 (RK) series</i>	98
Dolly fitting Comet:	
• <i>LW(-K), LWS(-K), LWR(-K), LWD(-K) series</i>	100
• <i>ZWD, ZWD-K series</i>	102
• <i>Ranger</i>	102
• <i>FW, FWS, FWD series</i>	103
• <i>TW, TWS, TWN series</i>	104
Dolly fitting Bertolini	106
Dolly fitting Cristanini	106
Dolly fitting Faip	106
Dolly fitting Cat	107
Dolly fitting Leuco / Hawk:	
• <i>D series</i>	108
• <i>SST series</i>	108
• <i>ST, MT, MTI series</i>	109
• <i>LT, LTI series</i>	110
• <i>XLT series</i>	111
Dolly fitting Kränzle	112
Dolly fitting Speck	113
Dolly fitting Lavor / Fasa	114
Dolly fitting Udor:	
• <i>PNC, PND, PNE, PNL series</i>	116
• <i>MC, MCW, MD, ME, ML, MKC, MKL series</i>	116
• <i>GHC, GHD, GKC, GKD series</i>	117
• <i>GB, GC, GD series</i>	118
Dolly fitting Kärcher:	
• <i>Pump set X891 ø14</i>	120
• <i>Pump set X172 ø18</i>	121
• <i>Pump set X322 ø20</i>	122
• <i>Pump set X913 ø20</i>	123
• <i>Pump set X302 ø22</i>	124
• <i>Set Dolly</i>	125
Dolly fitting Interpump / Generalpump:	
• <i>Table pump search</i>	126
• <i>44 series</i>	127
• <i>47 and 48 ø20 series</i>	129
• <i>47 and 48 ø22 series</i>	132
• <i>49, 50 series</i>	134
• <i>51 series</i>	137
• <i>61, 62 series</i>	139
• <i>63 series</i>	140
• <i>69 series</i>	141
• <i>76, 77 series</i>	142
• <i>Motor-pumps</i>	143
Set Dolly oil seals	145

Find in the following table, according to the pump you have to service, the series and page which includes all spares necessary to service your pump.

Pumps fitting	Series	Page	Pumps fitting	Series	Page	Pumps fitting	Series	Page	Pumps fitting	Series	Page
Annovi Reverberi			Annovi Reverberi			Annovi Reverberi			Annovi Reverberi		
CWX 15.15 N 950	194	96	RKA 4 G20 J+F22	228	98	SXMV 3 G35 N	178	94	XT 8.10 N	132	92
CWX 15.17 N 1750	194	96	RKA 4 G20 N	228	98	SXMV 3.5 G35 D+F40	178	94	XT 8.12 A C	132	92
CWX 15.17 N 1450	194	96	RKA 4 G30 A N	228	98	SXMV 3.5 G35 N	178	94	XT 8.12 A N	132	92
GRKV 4 G30 +F35	228	98	RKA 4 G30 H E	228	98	SXMV 4 G35 D+F40	178	94	XT 8.12 N	132	92
GRKV 4 G30A +F35	228	98	RKA 4 G30 H J+F22	228	98	SXMV 4 G35 N	178	94	XT 8.14 C	132	92
GRKV 4 G35H +F35	228	98	RKA G G30 H N	228	98	XM 11.17 C	178	94	XT 8.14 N	132	92
GXMV 4 G30 +F35	178	94	RKA 4 G30 N	228	98	XM 11.17 N	178	94	XT 8.15 N	132	92
HPE 8.12 A 1450	126	91	RKA 4 G36 H N	228	98	XM 13.17 C	178	94	XT 9.11 C	132	92
HPE 8.12 A 2800	126	91	RKA 4 G40 H N	228	98	XM 13.17 N	178	94	XT 9.11 N	132	92
HPE 8.14 1450	126	91	RKA 4.5 G17 N	228	98	XM 15.15 C	178	94	XT 9.14 C	132	92
HPE 8.14 2800	126	91	RKA 4.5 G25 H N	228	98	XM 15.15 N	178	94	XT 9.14 N	132	92
HPE 9.11 1450	126	91	RKA 4.5 G30 H N	228	98	XM 2 G10 E	178	94	XT 9.15 N	132	92
HPE 9.14 1450	126	91	RKA 4.5 G40 H N	228	98	XMA 2 G15 E	178	94	XT 10.10 N	132	92
HPE 10.10 1450	126	91	RKA 5.5 G13 E	228	98	XMA 2 G22 E	178	94	XT 10.12 A N	132	92
HPE 10.10 2800	126	91	RKA 5.5 G13 N	228	98	XMA 2.5 G18 E	178	94	XT 10.15 N	132	92
HPE 10.12 A 1450	126	91	RKA 5.5 G20 H N	228	98	XMA 3 G18 E	178	94	XT 11.07 N	132	92
HPE 10.12 A 2800	126	91	RKA 5.5 G26 H N	228	98	XMA 3 G25 E	178	94	XT 11.09 C	132	92
HPE 11.09 1450	126	91	RKA 5.5 G30 H N	228	98	XMA 3 G25 J+F22	178	94	XT 11.09 N	132	92
HPE 11.09 2800	126	91	RKA 6.5 G13 E	228	98	XMA 3 G25 N	178	94	XT 11.11 C	132	92
HPE 11.11 1450	126	91	RKA 6.5 G13 N	228	98	XMA 3.5 G22 E	178	94	XT 11.11 N	132	92
HPE 11.11 2800	126	91	RKA 6.5 G20 H E	228	98	XMA 3.5 G22 J+F22	178	94	XT 11.14 N	132	92
HPE 11.14 2800	126	91	RKA 6.5 G20 H N	228	98	XMA 3.5 G22 N	178	94	XT 11.15 N	132	92
HPE 13.09 2800	126	91	RKA 7 G13 E	228	98	XMA 3.5 G25 E	178	94	XT 13.09 C	132	92
HPE 13.10 1450	126	91	RKA 7 G13 N	228	98	XMA 3.5 G25 J+F22	178	94	XT 13.09 N	132	92
HPE 13.12 2800	126	91	RKA 7 G20 H E	228	98	XMA 3.5 G25 N	178	94	XT 13.12 A N	132	92
HPE 2 G15 1750	126	91	RKA 7 G20 H N	228	98	XMA 4 G20 E	178	94	XT 13.12 N	132	92
HPE 2 G18 1750	126	91	RKV 3.5 G25 D+F41	228	98	XMA 4 G20 J+F22	178	94	XT 13.15 N	132	92
HPE 3 G13 1750	126	91	RKV 3.5 G25 E+F32	228	98	XMA 4 G20 N	178	94	XTA 2 G15 E	132	92
HPE 3.5 G10 1750	126	91	RKV 3.5 G30H D+F41	228	98	XMS 11.17 C	178	94	XTA 2 G15 N	132	92
RK 11.14 N	228	98	RKV 3.5 G35H D+F41	228	98	XMS 11.17 N	178	94	XTA 2 G20 E	132	92
RK 11.20 H C	228	98	RKV 3.5 G40H D+F41	228	98	XMS 13.17 C	178	94	XTA 2 G20 N	132	92
RK 11.20 H N	228	98	RKV 4 G20 E+F32	228	98	XMS 13.17 N	178	94	XTA 2 G22 N	132	92
RK 11.25 H N	228	98	RKV 4 G30 D+F41	228	98	XMS 15.15 C	178	94	XTA 3 G16 E	132	92
RK 13.12 C	228	98	RKV 4 G30A D+F41	228	98	XMS 15.15 N	178	94	XTA 3 G16 N	132	92
RK 13.12 N	228	98	RKV 4 G32 D+F41	228	98	XMS 15.20 N	178	94	XTA 3 G19 E	132	92
RK 13.17 C	228	98	RKV 4 G35H D+F41	228	98	XMS 17.16 N	178	94	XTA 3 G19 N	132	92
RK 13.17 N	228	98	RKV 4 G40H D+F41	228	98	XMT 11.11 N	178	94	XTA 3 G22 N	132	92
RK 13.20 H C	228	98	RKV 4.5 G17 E+F32	228	98	XMTA 3.5 G22 N	178	94	XTA 3.5 G13 E	132	92
RK 13.20 H N	228	98	RKV 4.5 G40H D+F41	228	98	XMV 2 G10 E+F32	178	94	XTA 3.5 G13 N	132	92
RK 14.16 C	228	98	RKV 5.5 G13 E+F32	228	98	XMV 2 G15 E+F32	178	94	XTA 3.5 G17 E	132	92
RK 14.16 N	228	98	RKV 5.5 G40H D+F41	228	98	XMV 2 G22 E+F32	178	94	XTA 3.5 G17 N	132	92
RK 15.15 C	228	98	RW 15.15 N	298	97	XMV 2.5 G18 E+F32	178	94	XTA 3.5 G20 N	132	92
RK 15.15 N	228	98	RW 15.20H N	298	97	XMV 3 G18 E+F32	178	94	XTA 4 G10 N	132	92
RK 15.20 H C	228	98	RW 18.17 N	298	97	XMV 3 G25 D+F25	178	94	XTA 4 G15 E	132	92
RK 15.20 H N	228	98	RW 18.20H N	298	97	XMV 3 G25 D+F40	178	94	XTA 4 G15 N	132	92
RK 15.25 H N	228	98	RW 21.15H N	298	97	XMV 3 G25 N	178	94	XTS 8.10 C	132	92
RK 15.28 H N	228	98	RW 21.20H N	298	97	XMV 3 G30 D+F25	178	94	XTS 8.10 D	132	92
RK 18.12 C	228	98	SXM 11.20 C	178	94	XMV 3 G30 D+F40	178	94	XTS 8.10 N	132	92
RK 18.12 N	228	98	SXM 11.20 N	178	94	XMV 3 G30 N	178	94	XTS 8.12 A C	132	92
RK 18.16 H C	228	98	SXM 13.20 C	178	94	XMV 3.5 G22 D+F25	178	94	XTS 8.12 A D	132	92
RK 18.16 H N	228	98	SXM 13.20 N	178	94	XMV 3.5 G22 D+F40	178	94	XTS 8.12 A N	132	92
RK 18.20 H N	228	98	SXM 15.20 C	178	94	XMV 3.5 G22 N	178	94	XTS 8.12 N	132	92
RK 18.28 H N	228	98	SXM 15.20 N	178	94	XMV 3.5 G25 D+F25	178	94	XTS 8.14 C	132	92
RK 21.10 C	228	98	SXMA 3 G30 N	178	94	XMV 3.5 G25 D+F40	178	94	XTS 8.14 D	132	92
RK 21.10 N	228	98	SXMA 3.5 G30 N	178	94	XMV 3.5 G25 N	178	94	XTS 8.14 N	132	92
RK 21.15 H C	228	98	SXMA 4 G30 J+F22	178	94	XMV 3.5 G30 D+F40	178	94	XTS 8.15 N	132	92
RK 21.15 H N	228	98	SXMA 4 G30 N	178	94	XMV 4 G20 D+F40	178	94	XTS 10.10 N	132	92
RK 21.20 H N	228	98	SXMS 11.20 C	178	94	XMV 4 G20 N	178	94	XTS 10.12 A N	132	92
RKA 3.5 G22 N	228	98	SXMS 11.20 N	178	94	XMV 4 G22 D+F40	178	94	XTS 10.15 N	132	92
RKA 3.5 G25 E	228	98	SXMS 13.20 C	178	94	XMV 4 G22 N	178	94	XTS 11.09 C	132	92
RKA 3.5 G25 N	228	98	SXMS 13.20 N	178	94	XMV 4 G25 D+F40	178	94	XTS 11.09 N	132	92
RKA 3.5 G30 H E	228	98	SXMS 15.20 C	178	94	XMV 4 G25 N	178	94	XTS 11.11 C	132	92
RKA 3.5 G30 H N	228	98	SXMS 15.20 N	178	94	XMV 4 G30 D+F40	178	94	XTS 11.11 D	132	92
RKA 3.5 G40 H N	228	98	SXMS 17.20 N	178	94	XMV 4 G30 N	178	94	XTS 11.11 N	132	92
RKA 4 G20 E	228	98	SXMV 3 G35 D+F40	178	94	XT 8.10 C	132	92	XTS 11.14 C	132	92

<p>ZX.0861</p> <p>Kit Dolly A1864 valves + O-Rings</p>  <p>gr. 70 oz. 2.5</p> <p>quantity 2x6</p>	<p>ZX.0235</p> <p>Kit Dolly A1866 seal packing ø15</p>  <p>gr. 25 oz. 0.9</p> <p>quantity 6x3</p>	<p>ZX.0051</p> <p>Set Dolly A1866-60HP h.p. seals ø15x28</p>  <p>gr. 155 oz. 5.5</p> <p>quantity 1x60</p>	<p>ZX.0851</p> <p>Set Dolly A1866-60LP l.p. seals ø15x22</p>  <p>gr. 90 oz. 3.2</p> <p>quantity 1x60</p>
<p>ZX.0236</p> <p>Kit Dolly A1874 seal packing ø18</p>  <p>gr. 20 oz. 0.8</p> <p>quantity 4x3</p>	<p>ZX.0247</p> <p>Set Dolly A1874-60HP h.p. seals ø18x28</p>  <p>gr. 115 oz. 4.1</p> <p>quantity 1x60</p>	<p>ZX.0255</p> <p>Set Dolly A1874-60LP l.p. seals ø18x25</p>  <p>gr. 100 oz. 3.6</p> <p>quantity 1x60</p>	<p>ZX.0862</p> <p>Kit Dolly A2040 O-Rings</p>  <p>gr. 15 oz. 0.6</p>
<p>ZX.0099</p> <p>Kit Dolly A1865 oil seals</p>  <p>gr. 65 oz. 2.3</p>	<p>ZX.0098</p> <p>Kit Dolly A2628 ceramic plungers ø15x30</p>  <p>gr. 60 oz. 2.2</p> <p>quantity 1x3</p>	<p>ZX.0117</p> <p>Kit Dolly A2629 ceramic plungers ø18x30</p>  <p>gr. 80 oz. 2.9</p> <p>quantity 1x3</p>	

For pumps fitting Annovi Reverberi: 126 (HPE) series	Valves		Seal packing + O-Rings		Oil seals		Plungers	
	Kit Dolly A1864 ZX.0861	Kit Dolly A1866 ZX.0235	Kit Dolly A1874 ZX.0236	Kit Dolly A2040 ZX.0862	Kit Dolly A1865 ZX.0099	Kit Dolly A2628 ZX.0098	Kit Dolly A2629 ZX.0117	
HPE 8.12 A 1450	•	•		•	•	•		
HPE 8.12 A 2800	•	•		•	•	•		
HPE 8.14 1450	•	•		•	•	•		
HPE 8.14 2800	•	•		•	•	•		
HPE 9.11 1450	•		•	•	•		•	
HPE 9.14 1450	•		•	•	•		•	
HPE 10.10 1450	•		•	•	•		•	
HPE 10.10 2800	•	•		•	•	•		
HPE 10.12 A 1450	•		•	•	•		•	
HPE 10.12 A 2800	•	•		•	•	•		
HPE 11.09 1450	•		•	•	•		•	
HPE 11.09 2800	•	•		•	•	•		

For pumps fitting Annovi Reverberi: 126 (HPE) series	Valves		Seal packing + O-Rings		Oil seals		Plungers	
	Kit Dolly A1864 ZX.0861	Kit Dolly A1866 ZX.0235	Kit Dolly A1874 ZX.0236	Kit Dolly A2040 ZX.0862	Kit Dolly A1865 ZX.0099	Kit Dolly A2628 ZX.0098	Kit Dolly A2629 ZX.0117	
HPE 11.11 1450	•		•	•	•		•	
HPE 11.11 2800	•	•		•	•	•		
HPE 11.14 2800	•	•		•	•	•		
HPE 13.09 2800	•	•		•	•	•		
HPE 13.10 1450	•		•	•	•		•	
HPE 13.12 2800	•	•		•	•	•		
HPE 2 G15 1750	•	•		•	•	•		
HPE 2 G18 1750	•	•		•	•	•		
HPE 3 G13 1750	•		•	•	•		•	
HPE 3.5 G10 1750	•		•	•	•		•	

ZX.0861

Kit Dolly
A1864
valves + O-Rings



gr. 70
oz. 2.5

quantity
2x6



www.sparesclub.com

*The access to Club dei Riparatori web site
is even easier and more convenient !*

Come into our web site www.sparesclub.com

ZX.0235

Kit Dolly
A1866
seal packing
ø15



gr. 70
oz. 2.5

quantity
6x3

ZX.0051

Set Dolly
A1866-60HP
h.p. seals
ø15x28



gr. 155
oz. 5.5

quantity
1x60

ZX.0851

Set Dolly
A1866-60LP
l.p. seals
ø15x22



gr. 90
oz. 3.2

quantity
1x60

ZX.0493

Kit Dolly
A2520
seal packing
ø15



gr. 70
oz. 2.5

quantity
6x3

ZX.0854

Set Dolly
A2520-60HP
h.p. seals
ø15x28



gr. 155
oz. 5.5

quantity
1x60

ZX.0855

Set Dolly
A2520-60LP
l.p. seals
ø15x22



gr. 90
oz. 3.2

quantity
1x60

ZX.0236

Kit Dolly
A1874
seal packing
ø18



gr. 20
oz. 0.8

quantity
4x3

ZX.0247

Set Dolly
A1874-60HP
h.p. seals
ø18x28



gr. 115
oz. 4.1

quantity
1x60

ZX.0255

Set Dolly
A1874-60LP
l.p. seals
ø18x25



gr. 100
oz. 3.6

quantity
1x60

ZX.0878

Kit Dolly
A1860
oil seals



gr. 70
oz. 2.5

ZX.0111

Kit Dolly
A1872
oil seals



gr. 60
oz. 2.2

ZX.0098

Kit Dolly
A2628
ceramic
plungers
ø15x30

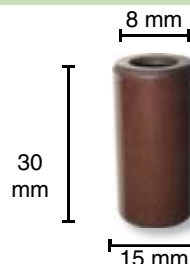

gr. 60
oz. 2.2

quantity
1x3

ZX.0117

Kit Dolly
A2629
ceramic
plungers
ø18x30

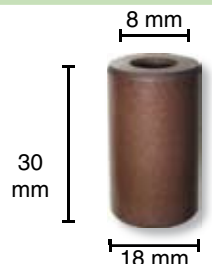

gr. 80
oz. 2.9

quantity
1x3

For pumps fitting Annovi Reverberi: 132 (XT) series	Valves		Seal packing		Oil seals		Plungers	
	Kit Dolly A1864 ZX.0861	Kit Dolly A1866 ZX.0235	Kit Dolly A2520 ZX.0493	Kit Dolly A1874 ZX.0236	Kit Dolly A1860 ZX.0878	Kit Dolly A1872 ZX.0111	Kit Dolly A2628 ZX.0098	Kit Dolly A2629 ZX.0117
	XT 8.10 C	•	•			•		•
XT 8.10 N	•	•				•	•	
XT 8.12 A C	•	•			•		•	
XT 8.12 A N	•	•				•	•	
XT 8.12 N	•	•				•	•	
XT 8.14 C	•	•			•		•	
XT 8.14 N	•	•				•	•	
XT 8.15 N	•	•				•	•	
XT 9.11 C	•		•		•			•
XT 9.11 N	•	•				•	•	
XT 9.14 C	•		•		•			•
XT 9.14 N	•		•			•	•	
XT 9.15 N	•		•			•	•	
XT 10.10 N	•		•			•	•	
XT 10.12 A N	•		•			•	•	
XT 10.15 N	•		•			•	•	
XT 11.07 N	•		•			•	•	
XT 11.09 C	•		•		•		•	
XT 11.09 N	•		•			•	•	
XT 11.11 C	•		•		•		•	
XT 11.11 N	•		•			•	•	
XT 11.14 N	•		•			•	•	
XT 11.15 N	•		•			•	•	
XT 13.09 C	•		•		•		•	
XT 13.09 N	•		•			•	•	
XT 13.12 A N	•		•			•	•	
XT 13.12 N	•		•			•	•	
XT 13.15 N	•		•			•	•	
XTA 2 G15 E	•	•			•		•	
XTA 2 G15 N	•	•				•	•	
XTA 2 G20 E	•	•			•		•	
XTA 2 G20 N	•	•				•	•	
XTA 2 G22 N	•	•				•	•	
XTA 3 G16 E	•		•		•			•
XTA 3 G16 N	•	•				•	•	
XTA 3 G19 E	•		•		•			•
XTA 3 G19 N	•		•			•	•	
XTA 3 G22 N	•		•			•	•	
XTA 3.5 G13 E	•		•		•			•
XTA 3.5 G13 N	•		•			•	•	
XTA 3.5 G17 E	•		•		•			•
XTA 3.5 G17 N	•		•			•	•	
XTA 3.5 G20 N	•		•			•	•	
XTA 4 G10 N	•		•			•	•	
XTA 4 G15 E	•		•		•			•
XTA 4 G15 N	•		•			•	•	
XTS 8.10 C	•	•			•		•	
XTS 8.10 D	•	•			•		•	
XTS 8.10 N	•	•				•	•	
XTS 8.12 A C	•	•			•		•	
XTS 8.12 A D	•	•			•		•	

For pumps fitting Annovi Reverberi: 132 (XT) series	Valves		Seal packing		Oil seals		Plungers	
	Kit Dolly A1864 ZX.0861	Kit Dolly A1866 ZX.0235	Kit Dolly A2520 ZX.0493	Kit Dolly A1874 ZX.0236	Kit Dolly A1860 ZX.0878	Kit Dolly A1872 ZX.0111	Kit Dolly A2628 ZX.0098	Kit Dolly A2629 ZX.0117
	XTS 8.12 A N	•	•				•	•
XTS 8.12 N	•	•				•	•	
XTS 8.14 C	•	•			•		•	
XTS 8.14 D	•	•			•		•	
XTS 8.14 N	•	•				•	•	
XTS 8.15 N	•	•				•	•	
XTS 10.10 N	•	•				•	•	
XTS 10.12 A N	•	•				•	•	
XTS 10.15 N	•	•				•	•	
XTS 11.09 C	•	•			•		•	
XTS 11.09 N	•	•				•	•	
XTS 11.11 C	•	•			•		•	
XTS 11.11 D	•	•			•		•	
XTS 11.11 N	•	•				•	•	
XTS 11.14 C	•	•			•		•	
XTS 11.14 D	•	•			•		•	
XTS 11.14 N	•	•				•	•	
XTS 11.15 N	•	•				•	•	
XTS 13.09 C	•	•			•		•	
XTS 13.09 D	•	•			•		•	
XTS 13.09 N	•	•				•	•	
XTS 13.12 A N	•	•				•	•	
XTS 13.12 C	•	•			•		•	
XTS 13.12 D	•	•			•		•	
XTS 13.12 N	•	•				•	•	
XTS 13.15 N	•	•				•	•	
XTV 2 G15 D	•			•	•		•	
XTV 2 G15 E	•			•	•		•	
XTV 2 G15 N	•			•	•		•	
XTV 2 G18 D	•			•	•		•	
XTV 2 G18 N	•			•	•		•	
XTV 2 G20 D	•			•	•		•	
XTV 2 G20 E	•			•	•		•	
XTV 2 G20 N	•			•	•		•	
XTV 2 G22 D	•			•	•		•	
XTV 2 G22 E	•			•	•		•	
XTV 2 G22 N	•			•	•		•	
XTV 3 G10 D	•			•	•		•	
XTV 3 G10 E	•			•	•		•	
XTV 3 G10 N	•			•	•		•	
XTV 3 G16 D	•			•	•		•	
XTV 3 G16 E	•			•	•		•	
XTV 3 G16 N	•			•	•		•	
XTV 3 G18 N	•			•	•		•	
XTV 3 G20 D	•			•	•		•	
XTV 3 G20 E	•			•	•		•	
XTV 3 G20 N	•			•	•		•	
XTV 3 G22 D	•			•	•		•	
XTV 3 G22 N	•			•	•		•	



**INNOVATIVE
PRESSURE
WASHERS**

IDROBASE®

www.idrobase.com

ZX.0861

**Kit Dolly
A1864**
valves + O-Rings

gr. 70
oz. 2.5

quantity
2x6

ZX.0879

**Kit Dolly
A2125**
valves + O-Rings

gr. 70
oz. 2.5

quantity
2x6

ZX.0647

**Kit Dolly
A2741**
seal packing
ø15

gr. 20
oz. 0.8

quantity
3X3

ZX.0857

**Set Dolly
A2741-60HP**
h.p. seals
ø15x28

gr. 155
oz. 5.5

quantity
1x60

ZX.0856

**Set Dolly
A2741-60LP**
l.p. seals
ø15x22

gr. 90
oz. 3.2

quantity
1x60

ZX.0643

**Kit Dolly
A2747**
seal packing
ø18

gr. 20
oz. 0.8

quantity
3X3

ZX.0858

**Set Dolly
A2747-60HP**
h.p. seals
ø18x28

gr. 115
oz. 4.1

quantity
1x60

ZX.0859

**Set Dolly
A2747-60LP**
l.p. seals
ø18x25

gr. 100
oz. 3.6

quantity
1x60

ZX.0880

**Kit Dolly
A2740**
head rings
ø15

gr. 10
oz. 0.4

quantity
1x3

ZX.0881

**Kit Dolly
A2745**
head rings
ø18

gr. 10
oz. 0.4

quantity
1x3



ZX.0882

**Kit Dolly
A2786**
oil seals

gr. 60
oz. 2.2

ZX.0883

**Kit Dolly
A2787**
oil seals

gr. 50
oz. 1.8

ZX.0884

**Kit Dolly
A2739**
ceramic
plungers
ø15x35

gr. 60
oz. 2.2

quantity
1x3

ZX.0885





**Kit Dolly
A2746**
ceramic
plungers
ø18x35

gr. 90
oz. 3.2



quantity
1x3

For pumps fitting Annovi Reverberi: 178 (XM) series	Valves		Seal packing				Oil seals		Plungers	
	Kit Dolly A1864 ZX.0861	Kit Dolly A2125 ZX.0879	Kit Dolly A2741 ZX.0647	Kit Dolly A2747 ZX.0643	Kit Dolly A2740 ZX.0880	Kit Dolly A2745 ZX.0881	Kit Dolly A2786 ZX.0882	Kit Dolly A2787 ZX.0883	Kit Dolly A2739 ZX.0884	Kit Dolly A2746 ZX.0885
	GXMV 4 G30 +F35	•		•		•			•	•
SXM 11.20 C	•		•		•			•	•	
SXM 11.20 N	•		•		•		•		•	
SXM 13.20 C	•			•		•		•		•
SXM 13.20 N	•			•		•	•			•
SXM 15.20 C	•			•		•		•		•
SXM 15.20 N	•			•		•	•			•
SXMA 3 G30 N	•		•		•		•		•	
SXMA 3.5 G30 N	•		•		•		•		•	
SXMA 4 G30 J+F22	•			•		•		•		•
SXMA 4 G30 N	•			•		•		•		•
SXMS 11.20 C		•	•		•			•	•	
SXMS 11.20 N		•	•		•		•		•	
SXMS 13.20 C		•	•		•			•	•	
SXMS 13.20 N		•	•		•		•		•	
SXMS 15.20 C		•	•		•			•	•	
SXMS 15.20 N		•	•		•		•		•	
SXMS 17.20 N		•	•		•		•		•	
SXMV 3 G35 D+F40		•	•		•			•	•	
SXMV 3 G35 N		•	•		•		•		•	
SXMV 3.5 G35 D+F40		•	•		•			•	•	
SXMV 3.5 G35 N		•	•		•		•		•	
SXMV 4 G35 D+F40		•	•		•			•	•	
SXMV 4 G35 N		•	•		•		•		•	
XM 11.17 C	•		•		•			•	•	
XM 11.17 N	•		•		•		•		•	
XM 13.17 C	•			•		•		•		•
XM 13.17 N	•			•		•	•			•
XM 15.15 C	•			•		•		•		•
XM 15.15 N	•			•		•	•			•
XMA 2 G10 E	•		•		•			•	•	
XMA 2 G15 E	•		•		•			•	•	
XMA 2 G22 E	•		•		•			•	•	
XMA 2.5 G18 E	•		•		•			•	•	
XMA 3 G18 E	•		•		•			•	•	
XMA 3 G25 E	•		•		•			•	•	
XMA 3 G25 J+F22	•		•		•			•	•	
XMA 3 G25 N	•		•		•		•		•	
XMA 3.5 G22 E	•		•		•			•	•	
XMA 3.5 G22 J+F22	•		•		•			•	•	
XMA 3.5 G22 N	•		•		•		•		•	
XMA 3.5 G25 E	•		•		•			•	•	



For pumps fitting Annovi Reverberi: 178 (XM) series	Valves		Seal packing				Oil seals		Plungers	
	Kit Dolly A1864 ZX.0861	Kit Dolly A2125 ZX.0879	Kit Dolly A2741 ZX.0647	Kit Dolly A2747 ZX.0643	Kit Dolly A2740 ZX.0880	Kit Dolly A2745 ZX.0881	Kit Dolly A2786 ZX.0882	Kit Dolly A2787 ZX.0883	Kit Dolly A2739 ZX.0884	Kit Dolly A2746 ZX.0885
	XMA 3.5 G25 J+F22	•		•		•			•	•
XMA 3.5 G25 N	•		•		•			•	•	
XMA 4 G20 E	•			•		•		•		•
XMA 4 G20 J+F22	•			•		•		•		•
XMA 4 G20 N	•			•		•	•			•
XMS 11.17 C	•		•		•			•	•	
XMS 11.17 N	•		•		•			•	•	
XMS 13.17 C	•		•		•			•	•	
XMS 13.17 N	•		•		•			•	•	
XMS 15.15 C	•		•		•			•	•	
XMS 15.15 N	•		•		•			•	•	
XMS 15.20 N	•		•		•			•	•	
XMS 17.16 N	•		•		•			•	•	
XMT 11.11 N	•		•		•			•	•	
XMTA 3.5 G22 N	•		•		•			•	•	
XMV 2 G10 E+F32	•		•		•			•	•	
XMV 2 G15 E+F32	•		•		•			•	•	
XMV 2 G22 E+F32	•		•		•			•	•	
XMV 2.5 G18 E+F32	•		•		•			•	•	
XMV 3 G18 E+F32	•		•		•			•	•	
XMV 3 G25 D+F25	•		•		•			•	•	
XMV 3 G25 D+F40	•		•		•			•	•	
XMV 3 G25 N	•		•		•			•	•	
XMV 3 G30 D+F25	•		•		•			•	•	
XMV 3 G30 D+F40	•		•		•			•	•	
XMV 3 G30 N	•		•		•			•	•	
XMV 3.5 G22 D+F25	•		•		•			•	•	
XMV 3.5 G22 D+F40	•		•		•			•	•	
XMV 3.5 G22 N	•		•		•			•	•	
XMV 3.5 G25 D+F25	•		•		•			•	•	
XMV 3.5 G25 D+F40	•		•		•			•	•	
XMV 3.5 G25 N	•		•		•			•	•	
XMV 3.5 G30 D+F40	•		•		•			•	•	
XMV 4 G20 D+F40	•		•		•			•	•	
XMV 4 G20 N	•		•		•			•	•	
XMV 4 G22 D+F40	•		•		•			•	•	
XMV 4 G22 N	•		•		•			•	•	
XMV 4 G25 D+F40	•		•		•			•	•	
XMV 4 G25 N	•		•		•			•	•	
XMV 4 G30 D+F40	•		•		•			•	•	
XMV 4 G30 N	•		•		•			•	•	

ZX.0869 Kit Dolly A2780 valves + O-Rings 		ZX.0870 Kit Dolly A2782 seal packing ø20 		ZX.0893 Set Dolly A2782-60HP h.p. seals ø20x32 		ZX.0894 Set Dolly A2782-60LP l.p. seals ø20x28 	
gr. 115 oz. 4.1	quantity 2x6	gr. 30 oz. 1.1	quantity 5x3	gr. 210 oz. 7.5	quantity 1x60	gr. 130 oz. 4.6	quantity 1x60

ZX.0871 Kit Dolly A2783 seal packing ø22 		ZX.0853 Set Dolly A2783-60HP h.p. seals ø22x32 		ZX.1109 Set Dolly A2783-60LP l.p. seals ø22x30 	
gr. 30 oz. 1.1	quantity 5x3	gr. 190 oz. 6.8	quantity 1x60	gr. 130 oz. 4.6	quantity 1x60

ZX.0872 Kit Dolly A2784 plunger guide ø20 		ZX.0873 Kit Dolly A2785 plunger guide ø22 	
gr. 360 oz. 12.8	quantity 2x3	gr. 330 oz. 11.7	quantity 2x3

ZX.0874 Kit Dolly A2781 oil seals 	
gr. 45 oz. 1.6	

ZX.0875 Kit Dolly A2650 ceramic plungers ø20x45 		ZX.0876 Kit Dolly A1891 ceramic plungers ø22x45 	
gr. 100 oz. 3.6	quantity 1x3	gr. 135 oz. 4.8	quantity 1x3

For pumps fitting Annovi Reverberi: 194 (XW) series	Valves		Seal packing		Plunger guides		Oil seals		Plungers	
	Kit Dolly 2780 ZX.0869	Kit Dolly 2782 ZX.0870	Kit Dolly 2783 ZX.0871	Kit Dolly 2784 ZX.0872	Kit Dolly 2785 ZX.0873	Kit Dolly 2781 ZX.0874	Kit Dolly 2650 ZX.0875	Kit Dolly 1891 ZX.0876		
CWX 15.17 N 950	•	•		•		•	•	•		
CWX 15.15 N 1450	•	•		•		•	•	•		
CWX 15.17 N 1750	•	•		•		•	•	•		
XW 15.15 N	•	•		•		•	•	•		
XW 15.20 N	•	•		•		•	•	•		
XW 15.30 N	•	•		•		•	•	•		
XW 21.20 N	•	•		•		•	•	•		
XW 21.25 N	•	•		•		•	•	•		
XW 21.28 N	•	•		•		•	•	•		
XW 26.12 N	•	•		•		•	•	•		
XW 26.15 N	•	•		•		•	•	•		
XW 26.20 N	•	•		•		•	•	•		
XW 26.23 N	•	•		•		•	•	•		
XW 30.10 N	•		•		•	•	•	•	•	
XW 30.15 N	•		•		•	•	•	•	•	
XW 30.20 N	•		•		•	•	•	•	•	
XW 30.25 N	•		•		•	•	•	•	•	
XWA 4 G20 N	•	•		•		•	•	•		
XWA 4 G30 N	•	•		•		•	•	•		
XWA 5.5 G22 N	•	•		•		•	•	•		
XWA 5.5 G30 N	•	•		•		•	•	•		
XWA 5.5 G40 N	•	•		•		•	•	•		
XWA 7 G22 N	•	•		•		•	•	•		
XWA 7 G32 N	•	•		•		•	•	•		
XWA 7 G35 N	•	•		•		•	•	•		
XWA 7 G40 N	•	•		•		•	•	•		
XWA 8 G19 N	•	•		•		•	•	•		
XWA 8 G29 N	•	•		•		•	•	•		
XWA 8 G35 N	•	•		•		•	•	•		
XWA 9 G16 N	•		•		•	•	•	•	•	
XWA 9 G24 N	•		•		•	•	•	•	•	
XWA 9 G30 N	•		•		•	•	•	•	•	

ZX.0886

Kit Dolly A42169
valves + O-Rings



gr. 70
oz. 2.5

quantity
2x6

ZX.0887

Kit Dolly A42171
seal packing
ø18



gr. 40
oz. 1.5

quantity
6x3

ZX.0860

Kit Dolly A42171-60HP
h.p. seals
ø18x32



gr. 220
oz. 7.8

quantity
1x60

ZX.0587

Kit Dolly A42171-60LP
l.p. seals
ø18x26



gr. 120
oz. 4.3

quantity
1x60

ZX.0888

Kit Dolly A42172
plunger guide



gr. 360
oz. 12.6

quantity
2x3

ZX.0889

Kit Dolly A42170
oil seals



gr. 50
oz. 1.8

ZX.0890

Kit Dolly A2872
ceramic plungers
ø18x48

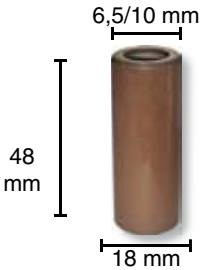

gr. 130
oz. 4.6

quantity
1x3

For pumps fitting Annovi Reverberi: 298 (RW) series	Valves	Seal packing	Plunger guides	Oil seals	Plungers
	Kit Dolly 42169 ZX.0886	Kit Dolly 42171 ZX.0887	Kit Dolly 42172 ZX.0888	Kit Dolly 42170 ZX.0889	Kit Dolly 2872 ZX.0890
RW 15.15 N	•	•	•	•	•
RW 15.20H N	•	•	•	•	•
RW 18.17 N	•	•	•	•	•
RW 18.20H N	•	•	•	•	•
RW 21.15H N	•	•	•	•	•
RW 21.20H N	•	•	•	•	•

Turnover and more important company performances reflect the companies health.

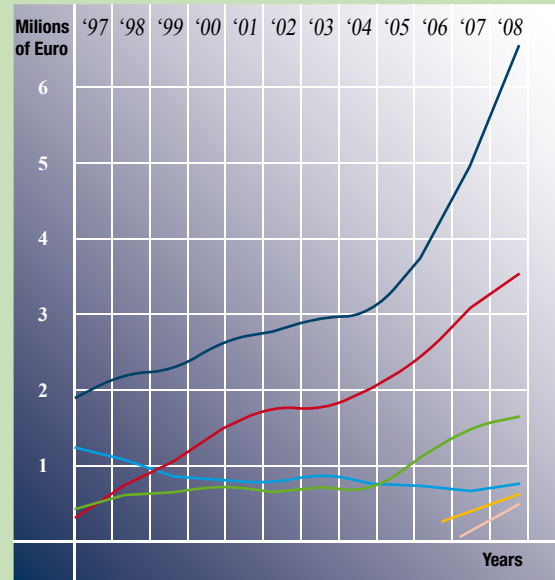















- Idrobases (h.p. washers) —
- Club dei Riparatori —
- Idrotech —
- Hydroeast —
- Perfect Cool —
- Gruppo Idrobases —

Idrobases Team

<p>ZX.0685 Kit Dolly A1828 valves + O-Rings</p>  <p>gr. 70 oz. 2.5</p> <p>quantity 2x6</p>	<p>ZX.0852 Kit Dolly A2864 valves + O-Rings</p>  <p>gr. 70 oz. 2.5</p> <p>quantity 2x6</p>	<p>ZX.0097 Kit Dolly A1857 seal packing ø18</p>  <p>gr. 25 oz. 0.9</p> <p>quantity 3x3</p>	<p>ZX.0171 Set Dolly A1857-60HP h.p. seals ø18x32</p>  <p>gr. 220 oz. 7.8</p> <p>quantity 1x60</p>	<p>ZX.0250 Set Dolly A1857-60LP l.p. seals ø18x26</p>  <p>gr. 115 oz. 4.1</p> <p>quantity 1x60</p>		
<p>ZX.0494 Kit Dolly A1887 seal packing ø20</p>  <p>gr. 30 oz. 1.1</p> <p>quantity 3x3</p>	<p>ZX.0249 Set Dolly A1887-60HP h.p. seals ø20x32</p>  <p>gr. 180 oz. 6.4</p> <p>quantity 1x60</p>	<p>ZX.0611 Set Dolly A1887-60LP l.p. seals ø20x28</p>  <p>gr. 120 oz. 4.3</p> <p>quantity 1x60</p>	<div data-bbox="1053 616 1364 772" data-label="Image"> </div> <p data-bbox="1029 784 1396 873">Do not be missed by the price !</p> <p data-bbox="1013 907 1412 1142">The quality of Club dei Riparatori® spare parts and accessories is the best in the market. The prices are so tempting only because we traded them without agents.</p> <p data-bbox="1037 1176 1388 1344">Club dei Riparatori®</p>			
<p>ZX.0863 Kit Dolly A1888 seal packing ø22</p>  <p>gr. 20 oz. 0.8</p> <p>quantity 3x3</p>	<p>ZX.0891 Set Dolly A1888-60HP h.p. seals ø22x32</p>  <p>gr. 160 oz. 5.7</p> <p>quantity 1x60</p>	<p>ZX.0892 Set Dolly A1888-60LP l.p. seals ø22x29</p>  <p>gr. 100 oz. 3.6</p> <p>quantity 1x60</p>				
<p>ZX.0864 Kit Dolly A1829 head rings ø18</p>  <p>gr. 15 oz. 0.6</p> <p>quantity 1x3</p>	<p>ZX.0865 Kit Dolly A1815 head rings ø20</p>  <p>gr. 15 oz. 0.6</p> <p>quantity 1x3</p>	<p>ZX.0866 Kit Dolly A1816 head rings ø22</p>  <p>gr. 15 oz. 0.6</p> <p>quantity 1x3</p>			<p>ZX.0112 Kit Dolly A1855 oil seals</p>  <p>gr. 75 oz. 2.7</p>	<p>ZX.0867 Kit Dolly A1856 oil seals</p>  <p>gr. 60 oz. 2.2</p>
<p>ZX.0096 Kit Dolly A2757 ceramic plungers ø18x40</p>  <p>gr. 85 oz. 3.0</p> <p>quantity 1x3</p>	<p>ZX.0492 Kit Dolly A2758 ceramic plungers ø20x40</p>  <p>gr. 130 oz. 4.6</p> <p>quantity 1x3</p>	<p>ZX.0868 Kit Dolly A2759 ceramic plungers ø22x40</p>  <p>gr. 140 oz. 5.0</p> <p>quantity 1x3</p>				



For pumps fitting Annovi Reverberi: 228 (RK) series	Valves		Seal packing + head rings						Oil seals		Plungers		
	Kit Dolly A1828 ZX.0685	Kit Dolly A2864 ZX.0852	Kit Dolly A1857 ZX.0097	Kit Dolly A1887 ZX.0494	Kit Dolly A1888 ZX.0863	Kit Dolly A1829 ZX.0864	Kit Dolly A1815 ZX.0865	Kit Dolly A1816 ZX.0866	Kit Dolly A1855 ZX.0112	Kit Dolly A1856 ZX.0867	Kit Dolly A2757 ZX.0096	Kit Dolly A2758 ZX.0492	Kit Dolly A2759 ZX.0868
RK 11.14 N		•	•			•			•		•		
RK 11.20 H N		•	•			•			•		•		
RK 11.20 H C		•	•			•				•			
RK 11.25 H N		•	•			•			•		•		
RK 13.12 N		•	•			•			•		•		
RK 13.12 C		•	•			•				•			
RK 13.17 C		•	•			•				•			
RK 13.17 N		•	•			•			•		•		
RK 13.20 H C		•	•			•				•			
RK 13.20 H N		•	•			•			•		•		
RK 14.16 C		•	•			•				•			
RK 14.16 N		•	•			•			•		•		
RK 15.15 C		•	•			•				•			
RK 15.15 N		•	•			•			•		•		
RK 15.20 H C		•	•			•				•			
RK 15.20 H N		•	•			•			•		•		
RK 15.25 H N		•	•			•			•		•		
RK 15.28 H N		•	•			•			•		•		
RK 18.12 C		•		•			•			•		•	
RK 18.12 N		•		•			•			•		•	
RK 18.16 H C		•		•			•			•		•	
RK 18.16 H N		•		•			•			•		•	
RK 18.20 H N		•		•			•			•		•	
RK 18.28 H N		•		•			•			•		•	
RK 21.10 C		•			•			•		•			•
RK 21.10 N		•			•			•		•			•
RK 21.15 H C		•			•			•		•			•
RK 21.15 H N		•			•			•		•			•
RK 21.20 H N		•			•			•		•			•
RKA 3.5 G22 N		•	•			•			•		•		
RKA 3.5 G25 E		•	•			•				•			
RKA 3.5 G25 N		•	•			•			•		•		
RKA 3.5 G30 H E		•	•			•				•			
RKA 3.5 G30 H N		•	•			•			•		•		
RKA 3.5 G40 H N		•	•			•			•		•		
RKA 4 G20 E		•	•			•				•			
RKA 4 G20 J+F22		•	•			•				•			
RKA 4 G20 N		•	•			•			•		•		
RKA 4 G30 A N		•	•			•				•			
RKA 4 G30 N		•	•			•			•		•		
RKA 4 G30 H E		•	•			•				•			
RKA 4 G30 H J+F22		•	•			•				•			
RKA 4 G30 H N		•	•			•			•		•		
RKA 4 G36 H N		•	•			•			•		•		
RKA 4 G40 H N		•	•			•			•		•		
RKA 4.5 G17 N		•	•			•			•		•		
RKA 4.5 G25 H N		•	•			•			•		•		
RKA 4.5 G30 H N		•	•			•			•		•		
RKA 4.5 G40 H N		•	•			•			•		•		
RKA 5.5 G13 E		•		•			•			•		•	
RKA 5.5 G13 N		•		•			•			•		•	
RKA 5.5 G20 H N		•		•			•			•		•	
RKA 5.5 G26 H N		•		•			•			•		•	
RKA 5.5 G30 H N		•		•			•			•		•	
RKA 6.5 G13 E		•		•			•			•		•	
RKA 6.5 G13 N		•		•			•			•		•	
RKA 6.5 G20 H E		•		•			•			•		•	
RKA 6.5 G20 H N		•		•			•			•		•	
RKA 7 G13 E		•		•			•			•		•	
RKA 7 G13 N		•		•			•			•		•	
RKA 7 G20 H E		•		•			•			•		•	
RKA 7 G20 H N		•		•			•			•		•	
RKV 3.5 G25 D+F41	•		•			•			•		•		•
RKV 3.5 G25 E+F32	•		•			•			•		•		•
RKV 3.5 G30H D+F41	•		•			•			•		•		•
RKV 3.5 G35H D+F41	•		•			•			•		•		•
RKV 3.5 G40H D+F41	•		•			•			•		•		•
RKV 4 G20 E+F32	•		•			•			•		•		•
RKV 4 G30A D+F41	•		•			•			•		•		•
RKV 4 G30 D+F41	•		•			•			•		•		•
RKV 4 G32 D+F41	•		•			•			•		•		•
RKV 4 G35H D+F41	•		•			•			•		•		•
RKV 4 G40H D+F41	•		•			•			•		•		•
RKV 4.5 G17 E+F32	•		•			•			•		•		•
RKV 4.5 G40H D+F41	•		•			•			•		•		•
RKV 5.5 G13 E+F32	•		•			•			•		•		•
RKV 5.5 G40H D+F41	•		•			•			•		•		•
GRKV 4 G30A +F35	•		•			•			•		•		•
GRKV 4 G30 +F35	•		•			•			•		•		•
GRKV 4 G35H +F35	•		•			•			•		•		•

<p>ZX.0029</p> <p>Kit Dolly Com5 valves + O-Rings</p>  <p>gr. 90 oz. 3.2</p> <p>quantity 3x6</p>	<p>ZX.0470</p> <p>Kit Dolly Com8 seal packing ø15</p>  <p>gr. 25 oz. 0.9</p> <p>quantity 4x3</p>	<p>ZX.0844</p> <p>Set Dolly Com8-60HP h.p. seals ø15x28</p>  <p>gr. 160 oz. 5.7</p> <p>quantity 1x60</p>
<p>ZX.0845</p> <p>Set Dolly Com8-60LP l.p. seals ø15x22</p>  <p>gr. 90 oz. 3.2</p> <p>quantity 1x60</p>	<p>ZX.0409</p> <p>KKit Dolly Com12 seal packing ø18</p>  <p>gr. 20 oz. 0.8</p> <p>quantity 4x3</p>	<p>ZX.0846</p> <p>Set Dolly Com12-60HP h.p. seals ø18x28</p>  <p>gr. 115 oz. 4.1</p> <p>quantity 1x60</p>
<p>ZX.0847</p> <p>Set Dolly Com12-60LP l.p. seals ø18x25</p>  <p>gr. 100 oz. 3.6</p> <p>quantity 1x60</p>	<p>ZX.0742</p> <p>Kit Dolly Com15 complete seal packing ø15</p>  <p>gr. 45 oz. 1.6</p> <p>quantity 5x1</p>	<p>ZX.0743</p> <p>Kit Dolly Com16 complete seal packing ø18</p>  <p>gr. 35 oz. 1.3</p> <p>quantity 5x1</p>
<p>ZX.0828</p> <p>Kit Dolly Com36 plunger oil seals ø15x24x5</p>  <p>gr. 15 oz. 0.6</p> <p>quantity 1x3</p>	<p>ZX.0829</p> <p>Kit Dolly Com37 shaft oil seal ø35x62x7</p>  <p>gr. 30 oz. 1.1</p> <p>quantity 1</p>	<p>ZX.0830</p> <p>Kit Dolly Com38 shaft oil seal ø25x62x10/7</p>  <p>gr. 40 oz. 1.5</p> <p>quantity 1</p>
<p>ZX.0444</p> <p>Kit Dolly Com14 plunger bolts</p>  <p>gr. 25 oz. 0.9</p> <p>quantity 4x3</p>	<p>CDR.0463</p> <p>Dolly Com6 ceramic plunger ø15x30</p>  <p>30 mm 9 mm 15 mm</p> <p>gr. 15 oz. 0.6</p> <p>quantity 1</p>	<p>CDR.0530</p> <p>Dolly Com11 ceramic plunger ø18x30</p>  <p>30 mm 9 mm 18 mm</p> <p>gr. 20 oz. 0.8</p> <p>quantity 1</p>

For pumps fitting Comet: LW(-K), LWS(-K), LWR(-K), LWD(-K) series	Valves			Seal packing		Complete seal packing			Oil seals			Plungers		
	ZX.0029	ZX.0470	ZX.0409	ZX.0742	ZX.0743	ZX.0828	ZX.0829	ZX.0830	ZX.0444	CDR.0463	CDR.0530			
LW 2015 S	•	•		•		•		•	•	•				
LW 2015 E	•	•		•		•	•	•	•	•				
LW 2020 S	•	•		•		•		•	•	•				
LW 2020 E	•	•		•		•	•	•	•	•				
LW 2520 S	•		•		•	•		•	•	•			•	
LW 3016 S	•		•		•	•		•	•	•			•	
LW 3016 E	•		•		•	•	•	•	•	•			•	
LW 3020 S	•		•		•	•		•	•	•			•	
LW 3025 S	•		•		•	•		•	•	•			•	
LW 3513 S	•		•		•	•		•	•	•			•	
LW 3513 E	•		•		•	•	•	•	•	•			•	
LW 3517 S	•		•		•	•		•	•	•			•	
LW 3525 S	•		•		•	•		•	•	•			•	
LWS 2010 S	•	•		•		•		•	•	•			•	
LWS 2010 E	•	•		•		•	•	•	•	•			•	
LWS 2015 S	•		•		•	•		•	•	•			•	
LWS 2015 E	•		•		•	•	•	•	•	•			•	
LWS 2020 S	•		•		•	•		•	•	•			•	
LWS 2020 E	•		•		•	•	•	•	•	•			•	
LWS 3010 S	•		•		•	•		•	•	•			•	
LWS 3010 E	•		•		•	•		•	•	•			•	
LWS 3015 S	•		•		•	•		•	•	•			•	
LWS 3020 S	•		•		•	•		•	•	•			•	
LWS 3020 E	•		•		•	•	•	•	•	•			•	
LWS 3025 S	•		•		•	•		•	•	•			•	
LWS 3508 S	•		•		•	•		•	•	•			•	
LWS 3513 S	•		•		•	•		•	•	•			•	
LWS 3517 S	•		•		•	•		•	•	•			•	
LWS 3525 S	•		•		•	•		•	•	•			•	
LWS 4007 S	•		•		•	•		•	•	•			•	
LWS 4015 S	•		•		•	•		•	•	•			•	
LWS 4020 S	•		•		•	•		•	•	•			•	
LWR 2015 S	•		•		•	•		•	•	•			•	
LWR 2015 E	•		•		•	•	•	•	•	•			•	
LWR 2020 S	•		•		•	•		•	•	•			•	
LWR 2020 E	•		•		•	•	•	•	•	•			•	
LWR 3016 S	•		•		•	•		•	•	•			•	
LWR 3016 E	•		•		•	•	•	•	•	•			•	
LWR 3020 S	•		•		•	•		•	•	•			•	
LWR 3020 E	•		•		•	•	•	•	•	•			•	
LWR 3025 S	•		•		•	•		•	•	•			•	
LWR 3513 S	•		•		•	•		•	•	•			•	
LWR 3513 E	•		•		•	•	•	•	•	•			•	
LWR 3517 S	•		•		•	•		•	•	•			•	
LWR 3517 E	•		•		•	•	•	•	•	•			•	
LWR 3525 S	•		•		•	•		•	•	•			•	
LWR 4022 S	•		•		•	•		•	•	•			•	
LWD 2010 S	•		•		•	•		•	•	•			•	
LWD 2010 E	•		•		•	•	•	•	•	•			•	
LWD 2010 G	•		•		•	•	•	•	•	•			•	
LWD 2015 S	•		•		•	•		•	•	•			•	
LWD 2015 E	•		•		•	•	•	•	•	•			•	
LWD 2015 G	•		•		•	•	•	•	•	•			•	
LWD 2020 S	•		•		•	•		•	•	•			•	
LWD 2020 E	•		•		•	•	•	•	•	•			•	
LWD 2020 G	•		•		•	•	•	•	•	•			•	
LWD 2520 G	•		•		•	•		•	•	•			•	

For pumps fitting Comet: LW(-K), LWS(-K), LWR(-K), LWD(-K) series	Valves			Seal packing		Complete seal packing			Oil seals			Plungers		
	ZX.0029	ZX.0470	ZX.0409	ZX.0742	ZX.0743	ZX.0828	ZX.0829	ZX.0830	ZX.0444	CDR.0463	CDR.0530			
LWD 2525 G	•	•		•		•		•	•	•			•	
LWD 3010 S	•			•		•		•	•	•			•	
LWD 3010 E	•			•		•	•	•	•	•			•	
LWD 3010 G	•			•		•	•	•	•	•			•	
LWD 3015 S	•			•		•		•	•	•			•	
LWD 3015 E	•			•		•	•	•	•	•			•	
LWD 3015 G	•			•		•	•	•	•	•			•	
LWD 3020 S	•			•		•		•	•	•			•	
LWD 3020 E	•			•		•	•	•	•	•			•	
LWD 3020 G	•			•		•	•	•	•	•			•	
LWD 3025 S	•			•		•		•	•	•			•	
LWD 3025 G	•			•		•	•	•	•	•			•	
LWD 3515 G	•			•		•	•	•	•	•			•	
LWD 3522 S	•			•		•		•	•	•			•	
LWD 3522 G	•			•		•	•	•	•	•			•	
LWD 4020 S	•			•		•		•	•	•			•	
LWD 4020 G	•			•		•	•	•	•	•			•	
LW-K 2020 E			•			•		•	•	•			•	
LW-K 3016 S	•		•		•	•		•	•	•			•	
LW-K 3016 E	•		•		•	•	•	•	•	•			•	
LW-K 3020 S	•		•		•	•		•	•	•			•	
LW-K 3025 S	•		•		•	•		•	•	•			•	
LW-K 3517 S	•		•		•	•		•	•	•			•	
LW-K 3525 S	•		•		•	•		•	•	•			•	
LWS-K 2010 E	•		•		•	•	•	•	•	•			•	
LWS-K 2020 S	•		•		•	•		•	•	•			•	
LWS-K 3015 S	•		•		•	•		•	•	•			•	
LWS-K 3019 S	•		•		•	•		•	•	•			•	
LWS-K 3025 S	•		•		•	•		•	•	•			•	
LWS-K 3517 S	•		•		•	•		•	•	•			•	
LWS-K 3525 S	•		•		•	•		•	•	•			•	
LWS-K 4020 S	•		•		•	•		•	•	•			•	
LWR-K 2020 S	•		•		•	•		•	•	•			•	
LWR-K 3016 S	•		•		•	•		•	•	•			•	
LWR-K 3016 E	•		•		•	•	•	•	•	•			•	
LWR-K 3020 S	•		•		•	•		•	•	•			•	
LWR-K 3025 S	•		•		•	•		•	•	•			•	
LWR-K 3517 S	•		•		•	•		•	•	•			•	
LWR-K 3525 S	•		•		•	•		•	•	•			•	
LWR-K 4022 S	•		•		•	•		•	•	•			•	
LWD-K 2010 E	•		•		•	•		•	•	•			•	
LWD-K 2010 G	•		•		•	•		•	•	•			•	
LWD-K 2015 E	•		•		•	•		•	•	•			•	
LWD-K 2015 G	•		•		•	•		•	•	•			•	
LWD-K 2020 E	•		•		•	•		•	•	•			•	
LWD-K 2020 G	•		•		•	•		•	•	•			•	
LWD-K 2520 G	•		•		•	•		•	•	•			•	
LWD-K 3010 E	•		•		•	•		•	•	•			•	
LWD-K 3010 G	•		•		•	•		•	•	•			•	
LWD-K 3015 E	•		•		•	•		•	•	•			•	
LWD-K 3015 G	•		•		•	•		•	•	•			•	
LWD-K 3020 E	•		•		•	•		•	•	•			•	
LWD-K 3020 G	•		•		•	•		•	•	•			•	
LWD-K 3025 G	•		•		•	•		•	•	•			•	
LWD-K 3522 G	•		•		•	•		•	•	•			•	
LWD-K 4020 G	•		•		•	•		•	•	•			•	

<p>ZX.0029 KiKit Dolly Com5 valves + O-Rings</p>  <p>gr. 90 oz. 3.2</p> <p>quantity 3x6</p>	<p>ZX.1114 Kit Dolly Com41 seal packing ø15</p>  <p>gr. 30 oz. 1.1</p> <p>quantity 5x3</p>	<p>ZX.0844 Set Dolly Com8-60HP h.p. seals ø15x28</p>  <p>gr. 160 oz. 5.6</p> <p>quantity 1x60</p>	<p>ZX.0845 Set Dolly Com8-60LP l.p. seals ø15x22</p>  <p>gr. 90 oz. 3.2</p> <p>quantity 1x60</p>																																																																																																																																															
<p>ZX.1115 Kit Dolly Com42 complete seal packing ø15</p>  <p>gr. 45 oz. 1.6</p> <p>quantity 6x1</p>	<p>ZX.0828 Kit Dolly Com36 plunger oil seals ø15x24x5</p>  <p>gr. 15 oz. 0.6</p> <p>quantity 1x3</p>	<p>ZX.1117 Kit Dolly Com43 shaft oil seal ø40x62x7</p>  <p>gr. 20 oz. 0.8</p> <p>quantity 1</p>	<table border="1"> <thead> <tr> <th rowspan="2">For pumps fitting Comet series: ZWD, ZWD-K:</th> <th>Valves</th> <th>Seal packing</th> <th>Complete seal packing</th> <th colspan="2">Oil seals</th> <th colspan="2">Plungers</th> </tr> <tr> <th>ZX.0029</th> <th>ZX.1114</th> <th>ZX.1115</th> <th>ZX.0828</th> <th>ZX.1117</th> <th>ZX.0830</th> <th>ZX.0444</th> <th>CDR.0463</th> </tr> </thead> <tbody> <tr><td>ZWD 2530 G</td><td>•</td><td>•</td><td>•</td><td>•</td><td>•</td><td></td><td>•</td><td>•</td></tr> <tr><td>ZWD 3030 G</td><td>•</td><td>•</td><td>•</td><td>•</td><td>•</td><td></td><td>•</td><td>•</td></tr> <tr><td>ZWD 3040 G</td><td>•</td><td>•</td><td>•</td><td>•</td><td>•</td><td></td><td>•</td><td>•</td></tr> <tr><td>ZWD 3522 G</td><td>•</td><td>•</td><td>•</td><td>•</td><td>•</td><td></td><td>•</td><td>•</td></tr> <tr><td>ZWD 3525 G</td><td>•</td><td>•</td><td>•</td><td>•</td><td>•</td><td></td><td>•</td><td>•</td></tr> <tr><td>ZWD 3530 G</td><td>•</td><td>•</td><td>•</td><td>•</td><td>•</td><td></td><td>•</td><td>•</td></tr> <tr><td>ZWD 3540 G</td><td>•</td><td>•</td><td>•</td><td>•</td><td>•</td><td></td><td>•</td><td>•</td></tr> <tr><td>ZWD 4020 G</td><td>•</td><td>•</td><td>•</td><td>•</td><td>•</td><td></td><td>•</td><td>•</td></tr> <tr><td>ZWD 4030 G</td><td>•</td><td>•</td><td>•</td><td>•</td><td>•</td><td></td><td>•</td><td>•</td></tr> <tr><td>ZWD 4040 G</td><td>•</td><td>•</td><td>•</td><td>•</td><td>•</td><td></td><td>•</td><td>•</td></tr> <tr><td>ZWD 4040 S</td><td>•</td><td>•</td><td>•</td><td>•</td><td>•</td><td>•</td><td>•</td><td>•</td></tr> <tr><td>ZWD-K 3030 G</td><td>•</td><td>•</td><td>•</td><td>•</td><td>•</td><td></td><td>•</td><td>•</td></tr> <tr><td>ZWD-K 3530 G</td><td>•</td><td>•</td><td>•</td><td>•</td><td>•</td><td></td><td>•</td><td>•</td></tr> <tr><td>ZWD-K 4030 G</td><td>•</td><td>•</td><td>•</td><td>•</td><td>•</td><td></td><td>•</td><td>•</td></tr> </tbody> </table>		For pumps fitting Comet series: ZWD, ZWD-K:	Valves	Seal packing	Complete seal packing	Oil seals		Plungers		ZX.0029	ZX.1114	ZX.1115	ZX.0828	ZX.1117	ZX.0830	ZX.0444	CDR.0463	ZWD 2530 G	•	•	•	•	•		•	•	ZWD 3030 G	•	•	•	•	•		•	•	ZWD 3040 G	•	•	•	•	•		•	•	ZWD 3522 G	•	•	•	•	•		•	•	ZWD 3525 G	•	•	•	•	•		•	•	ZWD 3530 G	•	•	•	•	•		•	•	ZWD 3540 G	•	•	•	•	•		•	•	ZWD 4020 G	•	•	•	•	•		•	•	ZWD 4030 G	•	•	•	•	•		•	•	ZWD 4040 G	•	•	•	•	•		•	•	ZWD 4040 S	•	•	•	•	•	•	•	•	ZWD-K 3030 G	•	•	•	•	•		•	•	ZWD-K 3530 G	•	•	•	•	•		•	•	ZWD-K 4030 G	•	•	•	•	•		•	•
For pumps fitting Comet series: ZWD, ZWD-K:	Valves	Seal packing	Complete seal packing	Oil seals		Plungers																																																																																																																																												
	ZX.0029	ZX.1114	ZX.1115	ZX.0828	ZX.1117	ZX.0830	ZX.0444	CDR.0463																																																																																																																																										
ZWD 2530 G	•	•	•	•	•		•	•																																																																																																																																										
ZWD 3030 G	•	•	•	•	•		•	•																																																																																																																																										
ZWD 3040 G	•	•	•	•	•		•	•																																																																																																																																										
ZWD 3522 G	•	•	•	•	•		•	•																																																																																																																																										
ZWD 3525 G	•	•	•	•	•		•	•																																																																																																																																										
ZWD 3530 G	•	•	•	•	•		•	•																																																																																																																																										
ZWD 3540 G	•	•	•	•	•		•	•																																																																																																																																										
ZWD 4020 G	•	•	•	•	•		•	•																																																																																																																																										
ZWD 4030 G	•	•	•	•	•		•	•																																																																																																																																										
ZWD 4040 G	•	•	•	•	•		•	•																																																																																																																																										
ZWD 4040 S	•	•	•	•	•	•	•	•																																																																																																																																										
ZWD-K 3030 G	•	•	•	•	•		•	•																																																																																																																																										
ZWD-K 3530 G	•	•	•	•	•		•	•																																																																																																																																										
ZWD-K 4030 G	•	•	•	•	•		•	•																																																																																																																																										
<p>ZX.0830 Kit Dolly Com38 shaft oil seal ø25x62x10/7</p>  <p>gr. 40 oz. 1.5</p> <p>quantity 1</p>	<p>ZX.0444 Dolly Com14 plunger bolts</p>  <p>gr. 25 oz. 0.9</p> <p>quantity 4x3</p>	<p>CDR.0463 Dolly Com6 ceramic plunger ø15x30</p>  <p>30 mm 9 mm 15 mm</p> <p>gr. 15 oz. 0.6</p> <p>quantity 1</p>																																																																																																																																																

<p>ZX.0831 Kit Dolly Com39 valves + O-Rings</p>  <p>gr. 90 oz. 3.2</p> <p>quantity 2x6</p>	<p>ZX.0469 Kit Dolly Com7 seal packing ø15</p>  <p>gr. 15 oz. 0.6</p> <p>quantity 3x3</p>	<p>ZX.0832 Kit Dolly Com9 piston oil seal ø15x24</p>  <p>gr. 20 oz. 0.8</p> <p>quantity 1x3</p>	<p>CDR.0484 Dolly Com10 plunger ø15</p>  <p>gr. 110 oz. 3.1</p> <p>quantity 1</p>	<p>Fitting Comet h.p. washers pumps:</p> <ul style="list-style-type: none"> - FD RANGER II - FD RANGER PLUS - KB - UNIDASH
---	--	--	--	---

ZX.0029	ZX.0557	ZX.0934
Kit Dolly Com5 valves + O-Rings	Kit Dolly Com1 seal packing ø18	Set Dolly Com1-60HP h.p. seals ø18x32
gr. 90 oz. 3.2	gr. 40 oz. 1.5	gr. 220 oz. 7.8
quantity 3x6	quantity 6x3	quantity 1x60

ZX.0558	ZX.0939
Kit Dolly Com2 seal packing ø20	Set Dolly Com2-60HP h.p. seals ø20x32
gr. 35 oz. 1.3	gr. 180 oz. 3.4
quantity 6x3	quantity 1x60

ZX.0744	ZX.0745
Kit Dolly Com17 complete seal packing ø18	Kit Dolly Com18 complete seal packing ø20
gr. 80 oz. 2.9	gr. 75 oz. 2.7
quantity 8x1	quantity 8x1

ZX.0825	ZX.0826	ZX.0827
Kit Dolly Com33 plunger oil seals ø20x30x5	Kit Dolly Com34 shaft oil seal ø25x52x7	Kit Dolly Com35 shaft oil seal ø40x52x7
gr. 20 oz. 0.8	gr. 25 oz. 0.9	gr. 20 oz. 0.8
quantity 1x3	quantity 1	quantity 1

ZX.0435	CDR.0693	CDR.0694
Kit Dolly Com13 plunger bolts	Dolly Com3 ceramic plunger ø18X44	Dolly Com4 ceramic plunger ø20X44
gr. 35 oz. 1.3	gr. 26 oz. 1.0	gr. 36 oz. 1.3
quantity 5x3	quantity 1	quantity 1

For pumps fitting Comet series: FW, FWS, FWD	Valves	Seal packing		Complete seal packing		Oil seals			Plungers		
	ZX.0029	ZX.0557	ZX.0558	ZX.0744	ZX.0745	ZX.0825	ZX.0826	ZX.0827	ZX.0435	CDR.0693	CDR.0694
FW 3016 S	•	•		•		•	•		•	•	
FW 3525 S	•	•		•		•	•		•	•	
FW 3525 E	•	•		•		•		•	•	•	
FW 3530 S	•	•		•		•	•		•	•	
FW 3530 E	•	•		•		•		•	•	•	
FW 4022 S	•	•		•		•	•		•	•	
FW 4022 E	•	•		•		•		•	•	•	
FW 4030 S	•	•		•		•	•		•	•	
FW 4030 E	•	•		•		•		•	•	•	
FW 5023 S	•		•		•	•	•		•		•
FW 5023 E	•		•		•	•		•	•		•
FW 5030 S	•		•		•	•	•		•		•
FW 5522 S	•		•		•	•	•		•		•
FW 5522 E	•		•		•			•	•		•
FW 5526 S	•		•		•	•	•		•		•
FW 5530 S	•		•		•	•	•		•		•
FWS 3522 E	•	•		•		•		•	•	•	
FWS 3530 S	•	•		•		•	•		•	•	
FWS 3530 E	•	•		•		•		•	•	•	
FWS 4022 E	•	•		•		•		•	•	•	
FWS 4030 S	•	•		•		•	•		•	•	
FWS 4030 E	•	•		•		•		•	•	•	
FWS 4030 G	•	•		•		•		•	•	•	
FWS 4525 S	•	•		•		•	•		•	•	
FWS 4530 S	•	•		•		•	•		•	•	
FWS 4530 E	•	•		•		•		•	•	•	
FWS 5520 S	•	•		•		•	•		•	•	
FWS 5525 S	•	•		•		•	•		•	•	
FWS 5530 E	•	•		•		•		•	•	•	
FWS 6020 S	•	•		•		•	•		•	•	
FWD 3522 E	•	•		•		•		•	•	•	
FWD 3522 G	•	•		•		•		•	•	•	
FWD 3530 E	•	•		•		•		•	•	•	
FWD 3530 G	•	•		•		•		•	•	•	
FWD 4020 E	•	•		•		•		•	•	•	
FWD 4020 G	•	•		•		•		•	•	•	
FWD 4030 E	•	•		•		•		•	•	•	
FWD 4030 G	•	•		•		•		•	•	•	
FWD 4517 G	•	•		•		•		•	•	•	
FWD 4525 G	•	•		•		•		•	•	•	
FWD 4530 E	•	•		•		•		•	•	•	
FWD 4530 G	•	•		•		•		•	•	•	
FWD 5513 G	•	•		•		•		•	•	•	

OFFER only for YOU
Only the best products chosen just for you!

**THE WINNING SOLUTION
TO MANUFACTURE AND REPAIR
ALL KINDS OF PRESSURE WASHERS**

**Club dei
Riparatori®**

ZX.0824

Kit Dolly Com19
valves
+ O-Rings



gr. 140
oz. 5.0

quantity
8x6

ZX.0814

Kit Dolly Com20
valves
+ O-Rings



gr. 140
oz. 5.0

quantity
7x6

ZX.0815

Kit Dolly Com21
seal packing
ø18



gr. 40
oz. 1.5

quantity
6x3

ZX.0952

Set Dolly Com21-60HP
h.p. seals
ø18x28



gr. 170
oz. 6.0

quantity
1x60

ZX.0940

Set Dolly Com21-60LP
l.p. seals
ø18x26



gr. 120
oz. 4.3

quantity
1x60

ZX.0816

Kit Dolly Com22
seal packing
ø22



gr. 40
oz. 1.5

quantity
6x3

ZX.0941

Set Dolly Com22-60HP
h.p. seals
ø22x32



gr. 190
oz. 6.7

quantity
1x60

ZX.0942

Set Dolly Com22-60LP
l.p. seals
ø22x30



gr. 130
oz. 4.6

quantity
1x60

ZX.0817

Kit Dolly Com23
seal packing
ø25



gr. 45
oz. 1.6

quantity
6x3

ZX.0959

Set Dolly Com23-60HP
h.p. seals
ø25x35



gr. 230
oz. 8.2

quantity
1x60



ZX.0960

Set Dolly Com23-60LP
l.p. seals
ø25x33



gr. 155
oz. 5.5

quantity
1x60

ZX.0818	ZX.0819	ZX.0820
Kit Dolly Com24 complete seal packing ø18	Kit Dolly Com25 complete seal packing ø22	Kit Dolly Com26 complete seal packing ø25
		
gr. 135 oz. 4.8	gr. 135 oz. 4.8	gr. 125 oz. 4.5
quantity 8x1	quantity 8x1	quantity 8x1

ZX.0813	ZX.0821
Kit Dolly Com27 plunger oil seals ø22x32x7	Dolly Com28 shaft oil seals ø30x52x7
	
gr. 30 oz. 1.1	gr. 25 oz. 0.9
quantity 1x3	quantity 1

ZX.0435	ZX.0823
Kit Dolly Com13 plunger bolts ø18	Kit Dolly Com29 plunger bolts ø22 e ø25
	
gr. 35 oz. 1.3	gr. 50 oz. 1.8
quantity 5x3	quantity 5x3



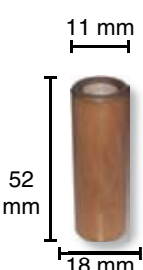
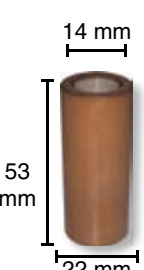
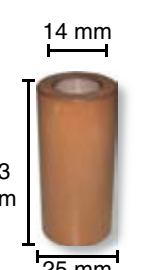

For pumps fitting Comet: TW, TWS, TWN series	Valves		Seal packing					Complete seal packing			Oil seals		Plungers		
	ZX.0824	ZX.0814	ZX.0815	ZX.0816	ZX.0817	ZX.0818	ZX.0819	ZX.0820	ZX.0813	ZX.0821	ZX.0435	ZX.0823	CDR.0627	CDR.0612	CDR.0613
TW 4545 S	•		•			•			•	•	•	•	•		
TW 5050 S	•		•			•			•	•	•	•	•		
TW 5550 S	•		•			•			•	•	•	•	•		
TW 7036 S		•	•			•			•	•	•	•	•		
TW 8030 S		•	•			•			•	•	•	•	•		
TW 8036 S		•	•			•			•	•	•	•	•		
TW 10025 S	•		•			•			•	•	•	•	•		•
TW 11025 S	•		•			•			•	•	•	•	•		•
TWS 5050 S	•		•			•			•	•	•	•	•		
TWS 5550 S	•		•			•			•	•	•	•	•		
TWS 7040 S	•		•			•			•	•	•	•	•		
TWS 8035 S		•	•			•			•	•	•	•	•		
TWS 9030 S		•	•			•			•	•	•	•	•		
TWS 10025 S	•		•			•			•	•	•	•	•		•
TWS 13020 S	•		•			•			•	•	•	•	•		•
TWN 6036 S	•		•			•			•	•	•	•	•		•
TWN 7025 S	•		•			•			•	•	•	•	•		•
TWN 8025 S	•		•			•			•	•	•	•	•		•

CDR.0627	CDR.0612	CDR.0613
Dolly Com30 ceramic plunger ø18x52	Dolly H6/Com31 ceramic plunger ø22x53	Dolly H6/Com32 ceramic plunger ø25x53
		
gr. 35 oz. 1.3	gr. 45 oz. 1.6	gr. 70 oz. 2.5
quantity 1	quantity 1	quantity 1



For pumps - Fitting Bertolini



Dolly Spare Parts® are Club dei Riparatori® by IDROBASE® products.

<p>ZX.0496 Kit Dolly B1 valvoline + O-Ring</p>  <p>gr. 85 oz. 3.0</p> <p>quantity 2X6</p>	<p>ZX.0559 Kit Dolly B17 seal packing ø18</p>  <p>gr. 20 oz. 0.8</p> <p>quantity 5x3</p>	<p>CDR.0002 Dolly B2 ceramic plunger ø18x32</p>  <p>9 mm 32 mm 18 mm</p> <p>gr. 23 oz. 0.9</p> <p>quantity 1</p>	<p>For pumps fitting Bertolini:</p> <p>KWE TW TWS</p>	<p>CDR.1245 Dolly B3 pistone ceramica ø18x42</p>  <p>11 mm 42 mm 18 mm</p> <p>per pompe TML 2015 e TML1520</p> <p>gr. 40</p> <p>quantity 1</p>
--	---	---	--	---



For pumps - Fitting Cristanini







Dolly Spare Parts® are Club dei Riparatori® by IDROBASE® products.













<p>ZX.0685 Kit Dolly A1828 valves + O-Rings</p>  <p>gr. 70 oz. 2.5</p> <p>quantity 2X6</p>	<p>ZX.0555 Kit Dolly Cris1 seal packing ø18</p>  <p>gr. 30 oz. 1.1</p> <p>quantity 3x3</p>	<p>ZX.0096 Kit Dolly A2757 ceramic plunger ø18x40</p>  <p>11 mm 40 mm 18 mm</p> <p>gr. 85 oz. 3.0</p> <p>quantity 1X3</p>	<p>H.p. washers pumps fitting Cristanini:</p> <p>GHIBLI TEQUENDAMA 150/15 GHIBLI TEQUENDAMA 200/15</p> <p>For pumps fitting Cristanini:</p> <p>TL 15/150 TL 15/200</p>
--	--	---	--



For pumps - Fitting Faip

Dolly Spare Parts® are Club dei Riparatori® by IDROBASE® products.

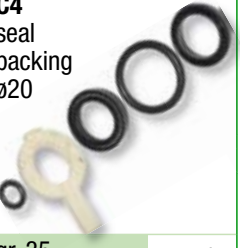
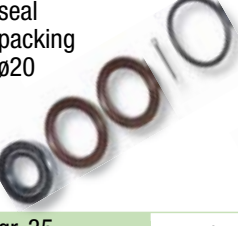













<p>ZX.0440 Kit Dolly A valves + O-Rings</p>  <p>gr. 96 oz. 3.4</p> <p>quantity 3x6</p>	<p>ZX.0403 Kit Dolly F3 seal packing and oil seals ø14, fitting Faip: American Fire</p>  <p>gr. 25 oz. 0.9</p> <p>quantity 3x3</p>	<p>ZX.0056 Kit Dolly F12 h.p. seals ø18x30</p>  <p>gr. 30 oz. 1.1</p> <p>quantity 1x6</p>	<p>ZX.0039 Kit Dolly F8 h.p. seals ø20x30</p>  <p>gr. 20 oz. 0.8</p> <p>quantity 1x6</p>	<p>ZX.0073 Kit Dolly F2 plunger oil seals ø20x30x7</p>  <p>gr. 25 oz. 0.9</p> <p>quantity 1x3</p>																													
<p>CDR.1244 Dolly F4 ceramic plunger ø18x42</p>  <p>12 mm 42 mm 18 mm</p> <p>gr. 40 oz. 1.4</p> <p>quantity 1</p>	<p>CR.A1412 Dolly F1 ceramic plunger ø20x42</p>  <p>12 mm 42 mm 20 mm</p> <p>gr. 33 oz. 1.2</p> <p>quantity 1</p>	<table border="1"> <thead> <tr> <th rowspan="2">For pumps fitting Faip</th> <th>Valves</th> <th>Seal packing</th> <th>Oil seals</th> <th>Plungers</th> </tr> <tr> <th>Kit Dolly A ZX.0440</th> <th>Kit Dolly F12 ZX.0056</th> <th>Kit Dolly F8 ZX.0039</th> <th>Kit Dolly F2 ZX.0073</th> <th>Dolly F4 CDR.1244</th> <th>Dolly F1 CR.A1412</th> </tr> </thead> <tbody> <tr> <td>TK 12</td> <td>•</td> <td>•</td> <td>•</td> <td>•</td> <td></td> </tr> <tr> <td>TK 15</td> <td>•</td> <td></td> <td>•</td> <td>•</td> <td>•</td> </tr> <tr> <td>TK 2115</td> <td>•</td> <td></td> <td>•</td> <td>•</td> <td>•</td> </tr> </tbody> </table>			For pumps fitting Faip	Valves	Seal packing	Oil seals	Plungers	Kit Dolly A ZX.0440	Kit Dolly F12 ZX.0056	Kit Dolly F8 ZX.0039	Kit Dolly F2 ZX.0073	Dolly F4 CDR.1244	Dolly F1 CR.A1412	TK 12	•	•	•	•		TK 15	•		•	•	•	TK 2115	•		•	•	•
For pumps fitting Faip	Valves	Seal packing	Oil seals	Plungers																													
	Kit Dolly A ZX.0440	Kit Dolly F12 ZX.0056	Kit Dolly F8 ZX.0039	Kit Dolly F2 ZX.0073	Dolly F4 CDR.1244	Dolly F1 CR.A1412																											
TK 12	•	•	•	•																													
TK 15	•		•	•	•																												
TK 2115	•		•	•	•																												

<p>ZX.0355</p> <p>Kit Dolly C1 valves + O-Rings</p>  <p>gr. 50 oz. 1.8</p> <p>quantity 2x3</p>	<p>ZX.0365</p> <p>Kit Dolly C2 valves + O-Rings</p>  <p>gr. 75 oz. 2.7</p> <p>quantity 8x3</p>	<p>ZX.0366</p> <p>Kit Dolly C3 valves + O-Rings</p>  <p>gr. 45 oz. 1.6</p> <p>quantity 3x3</p>
<p>ZX.0730</p> <p>Kit Dolly C12 valves + O-Rings</p>  <p>gr. 105 oz. 3.8</p> <p>quantity 7x3 6x3</p>	<p>ZX.0729</p> <p>Kit Dolly C13 valves + O-Rings</p>  <p>gr. 80 oz. 2.9</p> <p>quantity 3x3</p>	<p>ZX.0731</p> <p>Kit Dolly C14 valves + O-Rings</p>  <p>gr. 50 oz. 1.8</p> <p>quantity 3x3</p>
<p>ZX.0364</p> <p>Kit Dolly C7 seal packing ø16</p>  <p>gr. 30 oz. 1.1</p> <p>quantity 5x3</p>	<p>ZX.0362</p> <p>Kit Dolly C5 seal packing ø18</p>  <p>gr. 35 oz. 1.3</p> <p>quantity 5x3</p>	<p>ZX.0808</p> <p>Kit Dolly C8 seal packing ø18</p>  <p>gr. 35 oz. 1.3</p> <p>quantity 5x3</p>
<p>ZX.0809</p> <p>Kit Dolly C9 seal packing ø18</p>  <p>gr. 35 oz. 1.3</p> <p>quantity 9x3</p>	<p>ZX.0811</p> <p>Kit Dolly C11 seal packing ø18</p>  <p>gr. 35 oz. 1.3</p> <p>quantity 4x3</p>	
<p>ZX.0356</p> <p>Kit Dolly C4 seal packing ø20</p>  <p>gr. 35 oz. 1.3</p> <p>quantity 5x3</p>	<p>ZX.0363</p> <p>Kit Dolly C6 seal packing ø20</p>  <p>gr. 35 oz. 1.3</p> <p>quantity 5x3</p>	<p>ZX.0810</p> <p>Kit Dolly C10 seal packing ø20</p>  <p>gr. 35 oz. 1.3</p> <p>quantity 4x3</p>



For pumps fitting Cat	Valves					Seal packing							
	ZX.0355	ZX.0365	ZX.0366	ZX.0730	ZX.0729	ZX.0731	ZX.0364	ZX.0362	ZX.0808	ZX.0809	ZX.0356	ZX.0363	ZX.0810
30	•												
31	•												
34	•												
35	•												
53													
56					•								
57					•								
58										•			
59						•							
60						•							
230				•									
240				•									
270				•									
310	•												•
310W	•												•
340	•												•
340W	•												•
350	•												•
350W	•												•
530										•			
2SF10ES										•			
2SF20ES										•			
2SF22ELS										•			
2SF22ES										•			
2SF22SLS										•			
2SF29ELS										•			
2SF30ES										•			
2SF30GS										•			
2SF35ES										•			
2SF35GS										•			
2SFX20ES										•			
2SFX22ES										•			
2SFX22GS										•			
2SFX25ES										•			
2SFX25GZ										•			
2SFX29ELS										•			
2SFX30GS										•			
2SFX30GZ										•			
2SFZ35GS										•			
3CP1120						•						•	
3CP1130						•						•	
3CP1140						•						•	
4SF30GS1	•												•
4SF32ELS	•												•
4SF35GS1	•												•
4SF40ELS	•												•
4SF40GS1	•												•
4SF45ELS	•												•
4SF45GS1/GS118	•												•
4SF50ELS	•												•
4SF50GS1	•												•
5CP2120W	•												•
5CP2140WCS	•												•
5CP2150W	•												•
5CP6120													•
5CP6120G1													•
5DX30G1													•
5DX35G1													•
5DX40G1													•
5DX50G1													•
66DX30G11													•
66DX35G11													•
66DX40G11													•

<p>ZX.0055 Kit Dolly H8 valves + O-Rings</p>  <p>gr. 105 oz. 3.8</p> <p>quantity 3x6</p>	<p>ZX.0446 Kit Dolly H15 seal packing ø20</p>  <p>gr. 20 oz. 0.8</p> <p>quantity 5x3</p>	<p>ZX.0943 Set Dolly H13/15-60HP h.p. seals ø20x30</p>  <p>gr. 120 oz. 4.3</p> <p>quantity 1x60</p>	<p><i>For pumps fitting Hawk D series</i></p> <table border="1"> <thead> <tr> <th></th> <th>Valves</th> <th>Seal packing</th> <th>Complete seal packing</th> <th>Oil seals</th> <th>Plunger</th> </tr> <tr> <th></th> <th>ZX.0055</th> <th>ZX.0446</th> <th>ZX.0770</th> <th>ZX.0778</th> <th>ZX.0078</th> </tr> </thead> <tbody> <tr><td>HC165AL</td><td>•</td><td>•</td><td>•</td><td>•</td><td>•</td></tr> <tr><td>HC165AR</td><td>•</td><td>•</td><td>•</td><td>•</td><td>•</td></tr> <tr><td>HC168R</td><td>•</td><td>•</td><td>•</td><td>•</td><td>•</td></tr> <tr><td>HC170</td><td>•</td><td>•</td><td>•</td><td>•</td><td>•</td></tr> <tr><td>HC170L</td><td>•</td><td>•</td><td>•</td><td>•</td><td>•</td></tr> <tr><td>HC170R</td><td>•</td><td>•</td><td>•</td><td>•</td><td>•</td></tr> <tr><td>HC190</td><td>•</td><td>•</td><td>•</td><td>•</td><td>•</td></tr> <tr><td>HC190L</td><td>•</td><td>•</td><td>•</td><td>•</td><td>•</td></tr> <tr><td>HC190R</td><td>•</td><td>•</td><td>•</td><td>•</td><td>•</td></tr> </tbody> </table>						Valves	Seal packing	Complete seal packing	Oil seals	Plunger		ZX.0055	ZX.0446	ZX.0770	ZX.0778	ZX.0078	HC165AL	•	•	•	•	•	HC165AR	•	•	•	•	•	HC168R	•	•	•	•	•	HC170	•	•	•	•	•	HC170L	•	•	•	•	•	HC170R	•	•	•	•	•	HC190	•	•	•	•	•	HC190L	•	•	•	•	•	HC190R	•	•	•	•	•
	Valves	Seal packing	Complete seal packing	Oil seals	Plunger																																																																				
	ZX.0055	ZX.0446	ZX.0770	ZX.0778	ZX.0078																																																																				
HC165AL	•	•	•	•	•																																																																				
HC165AR	•	•	•	•	•																																																																				
HC168R	•	•	•	•	•																																																																				
HC170	•	•	•	•	•																																																																				
HC170L	•	•	•	•	•																																																																				
HC170R	•	•	•	•	•																																																																				
HC190	•	•	•	•	•																																																																				
HC190L	•	•	•	•	•																																																																				
HC190R	•	•	•	•	•																																																																				
<p>ZX.0770 Kit Dolly H25 complete seal packing ø20</p>  <p>gr. 70 oz. 2.5</p> <p>quantity 8x1</p>	<p>ZX.0778 Kit Dolly H34 plunger oil seals ø20x30x7</p>  <p>gr. 25 oz. 0.9</p> <p>quantity 1x3</p>	<p>ZX.0078 Kit Dolly H35 shaft oil seal ø25x42x7</p>  <p>gr. 20 oz. 0.8</p> <p>quantity 1</p>	<p>CDR.0610 Dolly H4 ceramic plunger ø20x38</p>  <p>38 mm 11 mm 20 mm</p> <p>gr. 35 oz. 1.3</p> <p>quantity 1</p>																																																																						



<p>ZX.0692 Kit Dolly H11 valves + O-Rings</p>  <p>gr. 320 oz. 11.3</p> <p>quantity 3x6</p>	<p>ZX.0642 Kit Dolly H12 seal packing ø18</p>  <p>gr. 30 oz. 1.1</p> <p>quantity 5x3</p>	<p>ZX.0944 Set Dolly H12-60HP h.p. seals ø18x30</p>  <p>gr. 100 oz. 3.6</p> <p>quantity 1x60</p>	<p><i>For pumps fitting Hawk SST series</i></p> <table border="1"> <thead> <tr> <th></th> <th>Valves</th> <th>Seal packing</th> <th>Complete seal packing</th> <th>Oil seals</th> <th>Plungers</th> </tr> <tr> <th></th> <th>ZX.0692</th> <th>ZX.0642</th> <th>ZX.0767</th> <th>ZX.0072</th> <th>ZX.0080</th> </tr> </thead> <tbody> <tr><td>HC310L</td><td>•</td><td>•</td><td>•</td><td>•</td><td>•</td></tr> <tr><td>HC310R</td><td>•</td><td>•</td><td>•</td><td>•</td><td>•</td></tr> <tr><td>HC320L</td><td>•</td><td>•</td><td>•</td><td>•</td><td>•</td></tr> <tr><td>HC320R</td><td>•</td><td>•</td><td>•</td><td>•</td><td>•</td></tr> <tr><td>HC330L</td><td>•</td><td>•</td><td>•</td><td>•</td><td>•</td></tr> <tr><td>HC330R</td><td>•</td><td>•</td><td>•</td><td>•</td><td>•</td></tr> <tr><td>HC340L</td><td>•</td><td>•</td><td>•</td><td>•</td><td>•</td></tr> <tr><td>HC340R</td><td>•</td><td>•</td><td>•</td><td>•</td><td>•</td></tr> <tr><td>HC350L</td><td>•</td><td>•</td><td>•</td><td>•</td><td>•</td></tr> <tr><td>HC350R</td><td>•</td><td>•</td><td>•</td><td>•</td><td>•</td></tr> <tr><td>HC370L</td><td>•</td><td>•</td><td>•</td><td>•</td><td>•</td></tr> <tr><td>HC370R</td><td>•</td><td>•</td><td>•</td><td>•</td><td>•</td></tr> <tr><td>HS310</td><td>•</td><td>•</td><td>•</td><td>•</td><td>•</td></tr> <tr><td>HS330L</td><td>•</td><td>•</td><td>•</td><td>•</td><td>•</td></tr> <tr><td>HS330R</td><td>•</td><td>•</td><td>•</td><td>•</td><td>•</td></tr> <tr><td>HS335CL</td><td>•</td><td>•</td><td>•</td><td>•</td><td>•</td></tr> <tr><td>HS335CR</td><td>•</td><td>•</td><td>•</td><td>•</td><td>•</td></tr> <tr><td>HS340L</td><td>•</td><td>•</td><td>•</td><td>•</td><td>•</td></tr> <tr><td>HS340R</td><td>•</td><td>•</td><td>•</td><td>•</td><td>•</td></tr> <tr><td>HS350L</td><td>•</td><td>•</td><td>•</td><td>•</td><td>•</td></tr> <tr><td>HS350R</td><td>•</td><td>•</td><td>•</td><td>•</td><td>•</td></tr> <tr><td>HS370L</td><td>•</td><td>•</td><td>•</td><td>•</td><td>•</td></tr> <tr><td>HS370R</td><td>•</td><td>•</td><td>•</td><td>•</td><td>•</td></tr> </tbody> </table>						Valves	Seal packing	Complete seal packing	Oil seals	Plungers		ZX.0692	ZX.0642	ZX.0767	ZX.0072	ZX.0080	HC310L	•	•	•	•	•	HC310R	•	•	•	•	•	HC320L	•	•	•	•	•	HC320R	•	•	•	•	•	HC330L	•	•	•	•	•	HC330R	•	•	•	•	•	HC340L	•	•	•	•	•	HC340R	•	•	•	•	•	HC350L	•	•	•	•	•	HC350R	•	•	•	•	•	HC370L	•	•	•	•	•	HC370R	•	•	•	•	•	HS310	•	•	•	•	•	HS330L	•	•	•	•	•	HS330R	•	•	•	•	•	HS335CL	•	•	•	•	•	HS335CR	•	•	•	•	•	HS340L	•	•	•	•	•	HS340R	•	•	•	•	•	HS350L	•	•	•	•	•	HS350R	•	•	•	•	•	HS370L	•	•	•	•	•	HS370R	•	•	•	•	•
	Valves	Seal packing	Complete seal packing	Oil seals	Plungers																																																																																																																																																								
	ZX.0692	ZX.0642	ZX.0767	ZX.0072	ZX.0080																																																																																																																																																								
HC310L	•	•	•	•	•																																																																																																																																																								
HC310R	•	•	•	•	•																																																																																																																																																								
HC320L	•	•	•	•	•																																																																																																																																																								
HC320R	•	•	•	•	•																																																																																																																																																								
HC330L	•	•	•	•	•																																																																																																																																																								
HC330R	•	•	•	•	•																																																																																																																																																								
HC340L	•	•	•	•	•																																																																																																																																																								
HC340R	•	•	•	•	•																																																																																																																																																								
HC350L	•	•	•	•	•																																																																																																																																																								
HC350R	•	•	•	•	•																																																																																																																																																								
HC370L	•	•	•	•	•																																																																																																																																																								
HC370R	•	•	•	•	•																																																																																																																																																								
HS310	•	•	•	•	•																																																																																																																																																								
HS330L	•	•	•	•	•																																																																																																																																																								
HS330R	•	•	•	•	•																																																																																																																																																								
HS335CL	•	•	•	•	•																																																																																																																																																								
HS335CR	•	•	•	•	•																																																																																																																																																								
HS340L	•	•	•	•	•																																																																																																																																																								
HS340R	•	•	•	•	•																																																																																																																																																								
HS350L	•	•	•	•	•																																																																																																																																																								
HS350R	•	•	•	•	•																																																																																																																																																								
HS370L	•	•	•	•	•																																																																																																																																																								
HS370R	•	•	•	•	•																																																																																																																																																								
<p>ZX.0767 Kit Dolly H22 complete seal packing ø18</p>  <p>gr. 80 oz. 2.9</p> <p>quantity 8x1</p>	<p>ZX.0072 Kit Dolly H32 plunger oil seals ø16x24x5</p>  <p>gr. 25 oz. 0.9</p> <p>quantity 1x3</p>	<p>ZX.0080 Kit Dolly H36 shaft oil seal ø25x62x10</p>  <p>gr. 40 oz. 1.5</p> <p>quantity 1</p>	<p>CDR.0609 Dolly H3 ceramic plunger ø18x39</p>  <p>9 mm 39 mm 18 mm</p> <p>gr. 30 oz. 1.1</p> <p>quantity 1</p>																																																																																																																																																										

<p>ZX.0055 Kit Dolly H8 valves + O-Rings</p>  <p>gr. 105 oz. 3.8</p> <p>quantity 3x6</p>	<p>ZX.1093 Kit Dolly H20 valves + O-Rings</p>  <p>gr. 90 oz. 3.2</p> <p>quantity 3x6</p>	<p>ZX.0642 Kit Dolly H12 h.p. seals ø18</p>  <p>gr. 120 oz. 4.3</p> <p>quantity 1x60</p>
<p>ZX.0944 Set Dolly H12-60HP h.p. seals ø18x30</p>  <p>gr. 120 oz. 4.3</p> <p>quantity 1x60</p>	<p>ZX.0248 Kit Dolly H13 seal packing ø20</p>  <p>gr. 25 oz. 0.9</p> <p>quantity 5x3</p>	<p>ZX.0943 Set Dolly H13/15-60HP h.p. seals ø20x30</p>  <p>gr. 120 oz. 4.3</p> <p>quantity 1x60</p>
<p>ZX.0766 Kit Dolly H21 complete seal packing ø18</p>  <p>gr. 95 oz. 3.4</p> <p>quantity 8x1</p>	<p>ZX.0768 Kit Dolly H23 complete seal packing ST ø20</p>  <p>gr. 85 oz. 3.0</p> <p>quantity 8x1</p>	<p>ZX.0769 Kit Dolly H24 complete seal packing MT-MTI ø20</p>  <p>gr. 85 oz. 3.0</p> <p>quantity 8x1</p>
<p>ZX.0072 Kit Dolly H32 plunger oil seals ø16x24x5</p>  <p>gr. 25 oz. 0.9</p> <p>quantity 1x3</p>	<p>ZX.0778 Kit Dolly H34 plunger oil seals ø20x30x7</p>  <p>gr. 25 oz. 0.9</p> <p>quantity 1x3</p>	<p>ZX.0078 Kit Dolly H35 shaft oil seal ø25x42x7</p>  <p>gr. 20 oz. 0.8</p> <p>quantity 1</p>
<p>ZX.0079 Kit Dolly H33 shaft oil seal ø25x47x7</p>  <p>gr. 20 oz. 0.8</p> <p>quantity 1</p>	<p>CDR.0464 Dolly H2 ceramic plunger ø18x46</p>  <p>11 mm 46 mm 18 mm</p> <p>gr. 30 oz. 1.1</p> <p>quantity 1</p>	<p>CR.A1126 Dolly H1 ceramic plunger ø20x46</p>  <p>11 mm 46 mm 20 mm</p> <p>gr. 40 oz. 1.5</p> <p>quantity 1</p>

For pumps fitting Hawk	Valves		Seal packing		Complete seal packing			Oil seals				Plungers	
	ZX.0055	ZX.1093	ZX.0642	ZX.0248	ZX.0766	ZX.0768	ZX.0769	ZX.0072	ZX.0778	ZX.0078	ZX.0079	CDR.0464	CR.A1126
ST series:													
HC200A	•		•		•				•	•		•	
HC200AL	•		•		•				•	•		•	
HC200AR	•		•		•				•	•		•	
HC205AL	•		•		•				•	•		•	
HC205AR	•		•		•				•	•		•	
HC215R	•					•					•		•
HC235R	•			•		•					•		•
HC240A	•		•		•				•	•		•	
HC240AL	•		•		•				•	•		•	
HC240AR	•		•		•				•	•		•	
HC240I	•		•		•				•	•		•	
HC240IL	•		•		•				•	•		•	
HC240IR	•		•		•				•	•		•	
HC280A	•		•		•				•	•		•	
HC280AL	•		•		•				•	•		•	
HC280AR	•		•		•				•	•		•	
MT series:													
H300	•	•		•			•	•			•		•
H300L	•	•		•			•	•			•		•
H300R	•	•		•			•	•			•		•
H306	•	•		•			•	•			•		•
H306R	•	•		•			•	•			•		•
H306A	•	•		•			•	•			•		•
H400	•	•		•			•	•			•		•
H406	•	•		•			•	•			•		•
HC450	•	•		•			•	•			•		•
HC450L	•	•		•			•	•			•		•
HC450R	•	•		•			•	•			•		•
HC456	•	•		•			•	•			•		•
HC456L	•	•		•			•	•			•		•
HC456R	•	•		•			•	•			•		•
HC460L	•	•		•			•	•			•		•
HC460R	•	•		•			•	•			•		•
HC500	•	•		•			•	•			•		•
HC500L	•	•		•			•	•			•		•
HC500R	•	•		•			•	•			•		•
HC506	•	•		•			•	•			•		•
HC506L	•	•		•			•	•			•		•
HC506R	•	•		•			•	•			•		•
HC530L	•	•		•			•	•			•		•
HC530R	•	•		•			•	•			•		•
HC536L	•	•		•			•	•			•		•
HC536R	•	•		•			•	•			•		•
HC550	•	•		•			•	•			•		•
HC556	•	•		•			•	•			•		•
HC580L	•	•		•			•	•			•		•
HC580R	•	•		•			•	•			•		•
HC586L	•	•		•			•	•			•		•
HC586R	•	•		•			•	•			•		•
MTI series:													
HC450IL	•		•				•	•			•		•
HC450IR	•		•				•	•			•		•
HC450SIL	•		•				•	•			•		•
HC450SIR	•		•				•	•			•		•
HC456IL	•		•				•	•			•		•
HC456IR	•		•				•	•			•		•
HC456SIL	•		•				•	•			•		•
HC456SIR	•		•				•	•			•		•
HC500IL	•		•				•	•			•		•
HC500IR	•		•				•	•			•		•
HC500SIL	•		•				•	•			•		•
HC500SIR	•		•				•	•			•		•
HC506IL	•		•				•	•			•		•
HC506IR	•		•				•	•			•		•
HC506SIL	•		•				•	•			•		•
HC506SIR	•		•				•	•			•		•
HC550IL	•		•				•	•			•		•
HC550IR	•		•				•	•			•		•
HC556IL	•		•				•	•			•		•
HC556IR	•		•				•	•			•		•
HC570IL	•		•				•	•			•		•
HC570IR	•		•				•	•			•		•
HC576IL	•		•				•	•			•		•
HC576IR	•		•				•	•			•		•

ZX.0055	ZX.0447	ZX.0945
Kit Dolly H8 valves + O-Rings	Kit Dolly H16 seal packing ø20	Set Dolly H16-60HP h.p. seals ø20x35
		
gr. 105 oz. 3.8	gr. 45 oz. 1.6	gr. 255 oz. 9.0
quantity 3x6	quantity 5x3	quantity 1x60

ZX.0448	ZX.0946
Kit Dolly H18 seal packing ø22	Set Dolly H18-60HP h.p. seals ø22x35
	
gr. 40 oz. 1.5	gr. 230 oz. 8.2
quantity 5x3	quantity 1x60

ZX.0449	ZX.0953
Kit Dolly H23 seal packing ø25	Set Dolly H23-60HP h.p. seals ø25x35
	
gr. 30 oz. 1.1	gr. 140 oz. 5.0
quantity 5x3	quantity 1x60

ZX.0771
Kit Dolly H26 complete seal packing ø20

gr. 155 oz. 5.5
quantity 8x1

ZX.0772
Kit Dolly H28 complete seal packing ø22

gr. 140 oz. 5.0
quantity 8x1

ZX.0773
Kit Dolly H30 complete seal packing ø25

gr. 135 oz. 4.8
quantity 8x1

ZX.0778
Kit Dolly H34 plunger oil seals ø20x30x7

gr. 25 oz. 0.9
quantity 1x3

ZX.0688
Kit Dolly H37 shaft oil seal ø30x55x7

gr. 25 oz. 0.9
quantity 1

CDR.0611
Dolly H5 ceramic plunger ø20x53

gr. 35 oz. 1.3
quantity 1

CDR.0612
Dolly H6 ceramic plunger ø22x53

gr. 50 oz. 1.8
quantity 1

CDR.0613
Dolly H7 ceramic plunger ø25x53

gr. 70 oz. 2.5
quantity 1

For pumps fitting Hawk	Valves	Seal packing		Complete seal packing			Oil seals		Plungers			
	ZX.0055	ZX.0447	ZX.0448	ZX.0449	ZX.0771	ZX.0772	ZX.0773	ZX.0778	ZX.0688	CDR.0611	CDR.0612	CDR.0613
LT series:												
H450	•	•			•			•	•	•		
H500	•		•			•		•	•		•	
H600				•			•	•	•			•
H700	•			•			•	•	•			•
H700R	•			•			•	•	•			•
HC600	•	•			•			•	•	•		
HC650	•		•			•		•	•			•
HC650L	•		•			•		•	•			•
HC650R	•		•			•		•	•			•
HC700				•			•	•	•			•
HC800	•			•			•	•	•			•
HC800L	•			•			•	•	•			•
HC800R	•			•			•	•	•			•
LTI series												
HC600IR	•	•			•			•	•	•		
HC650IL	•		•			•		•	•			•
HC650IR	•		•			•		•	•			•
HC800IL	•			•			•	•	•			•
HC800IR	•			•			•	•	•			•

ZX.0690	ZX.0691
Kit Dolly H9 valves + O-Rings	Kit Dolly H10 valves + O-Rings
gr. 320 oz. 11.3	gr. 190 oz. 6.8
quantity 3x6	quantity 3x6

ZX.0433	ZX.0954
Kit Dolly H14 seal packing ø20	Set Dolly H14-60HP h.p. seals + head rings ø20x35
gr. 60 oz. 2.2	gr. 440 oz. 15.6
quantity 6x3	quantity 2x60

ZX.0445	ZX.0955
Kit Dolly H17 seal packing ø22	Set Dolly H17-60HP h.p. seals + head rings ø22x35
gr. 50 oz. 1.8	gr. 375 oz. 13.3
quantity 6x3	quantity 2x60

For pumps fitting Hawk XLT series	Valves		Seal packing		Complete seal packing		Oil seals		Plungers				
	ZX.0690	ZX.0691	ZX.0433	ZX.0445	ZX.0434	ZX.0774	ZX.0775	ZX.0776	ZX.0778	ZX.0688	CDR.0611	CDR.0612	CDR.0613
HC930A	•		•			•			•	•	•		
HC930AL	•		•			•			•	•	•		
HC930AR	•		•			•			•	•	•		
HC932AL	•		•			•			•	•	•		
HC932AR	•		•			•			•	•	•		
HC932L	•		•			•			•	•	•		
HC932R	•		•			•			•	•	•		
HC940A		•		•			•		•	•		•	
HC940AL		•		•			•		•	•		•	
HC940AR		•		•			•		•	•		•	
HC950A		•			•			•	•	•			•
HC950AL		•			•			•	•	•			•
HC950AR		•			•			•	•	•			•
HC960A		•		•				•	•	•			•
HC960AL		•		•				•	•	•			•
HC960AR		•		•				•	•	•			•
HC980A		•						•	•				
HC980AL		•						•	•				
HC980AR		•						•	•				

ZX.0434
Kit Dolly H19 seal packing ø25
gr. 50 oz. 1.8
quantity 6x3

ZX.0956
Set Dolly H19-60HP h.p. seals + head rings ø25x35
gr. 310 oz. 11.0
quantity 2x60

ZX.0774
Kit Dolly H27 complete seal packing ø20
gr. 150 oz. 5.3
quantity 9x1

ZX.0775
Kit Dolly H29 complete seal packing ø22
gr. 140 oz. 5.0
quantity 9x1

ZX.0776
Kit Dolly H31 complete seal packing ø25
gr. 125 oz. 4.5
quantity 9x1











ZX.0778
Kit Dolly H34 plunger oil seals ø20x30x7
gr. 25 oz. 0.9
quantity 1x3

ZX.0688
Kit Dolly H37 shaft oil seal ø30x55x7
gr. 25 oz. 0.9
quantity 1

CDR.0611
Dolly H5 ceramic plunger ø20x53
gr. 35 oz. 1.3
quantity 1

CDR.0612
Dolly H6 ceramic plunger ø22x53
gr. 50 oz. 1.8
quantity 1



CDR.0613
Dolly H7 ceramic plunger ø25x53
gr. 70 oz. 2.5
quantity 1





<p>ZX.0787 Kit Dolly KR11 valves + O-Ring</p>  <p>gr. 100 oz. 3.6</p> <p>quantity 3x6</p>	<p>ZX.0788 Kit Dolly KR12 valves + O-Ring</p>  <p>gr. 90 oz. 3.2</p> <p>quantity 3x6</p>	<p>ZX.0789 Kit Dolly KR13 valves + O-Ring</p>  <p>gr. 60 oz. 2.2</p> <p>quantity 3x6</p>	<p>ZX.0783 Kit Dolly KR7 seal packing ø12</p>  <p>gr. 15 oz. 0.6</p> <p>quantity 3x3</p>	<p>ZX.0683 Kit Dolly KR2 seal packing ø14</p>  <p>gr. 20 oz. 0.8</p> <p>quantity 4x3</p>
<p>ZX.0784 Kit Dolly KR8 seal packing ø14</p>  <p>gr. 30 oz. 1.1</p> <p>quantity 6x3</p>	<p>ZX.0421 Kit Dolly KR5 seal packing ø15</p>  <p>gr. 25 oz. 0.9</p> <p>quantity 6x3</p>	<p>ZX.0620 Kit Dolly KR1 seal packing ø18</p>  <p>gr. 25 oz. 0.9</p> <p>quantity 6x3</p>	<p>ZX.0411 Kit Dolly KR4 seal packing ø20</p>  <p>gr. 30 oz. 1.1</p> <p>quantity 6x3</p>	<p>ZX.0786 Kit Dolly KR10 seal packing ø20</p>  <p>gr. 30 oz. 1.1</p> <p>quantity 6x3</p>



For pumps fitting Kränzle	Valves				Seal packing					
	ZX.0787	ZX.0788	ZX.0789	ZX.0783	ZX.0683	ZX.0784	ZX.0421	ZX.0620	ZX.0411	ZX.0786
105			•		•					
115		•						•		
125		•						•		
130		•						•		
135		•						•		
145 T		•						•		
150		•						•		
155		•						•		
160 TS T		•						•		
175 T		•						•		
185		•				•				
195 TS T		•					•			
205 T		•					•			
AQ 10-250	•								•	
AQ 13-230	•								•	
AQ 15-200	•								•	
AQ 19-160	•								•	
AX/10-250										•
AX/13-220										•
AX/16-200										•
AX/20-160										•
B10/200		•						•		
B13/150		•						•		
B16/220	•								•	
B170 T		•						•		
B200 T		•						•		
B230 T	•								•	
B240 T	•								•	
B270 T	•								•	
D 26/250	•							•		
D 26/250 TST	•							•		
D 30/180 TST	•							•		
D 30/220	•							•		
HD 10/100 E		•				•				
HD 10/100 S		•						•		



For pumps fitting Kränzle	Valves				Seal packing					
	ZX.0787	ZX.0788	ZX.0789	ZX.0783	ZX.0683	ZX.0784	ZX.0421	ZX.0620	ZX.0411	ZX.0786
HD 10/120			•		•					
HD 12/130		•						•		
HD 12/130 S		•						•		
HD 12/140 D		•						•		
HD 10-250	•								•	
HD 13-230	•								•	
HD 15-200	•								•	
HD 16-180	•								•	
HD 19-160	•								•	
HD 670 S								•		
HD 690 S		•						•		
HD 7/120			•		•					
HD 9/80 L								•		
HD 9/80 E								•		
HD 9/80 L		•						•		
JUNIOR 120				•						
JUNIOR 140				•						
1120			•		•					
1120 T			•		•					
1150			•		•					
1150 T			•		•					
3170 TST	•								•	
3200 TST	•								•	
3250	•								•	
3250 TST	•								•	
3270 TST	•								•	
POWER JET			•		•					
Profi-jet 10-250	•								•	
Profi-jet 13-230	•								•	
Profi-jet 15-200	•								•	
Profi-jet 16-180	•								•	
Profi-jet 19-160	•								•	
Profi-jet 100									•	
Profi-jet 130									•	
Profi-jet 150 D									•	



For pumps fitting Kränzle	Valves				Seal packing					
	ZX.0787	ZX.0788	ZX.0789	ZX.0783	ZX.0683	ZX.0784	ZX.0421	ZX.0620	ZX.0411	ZX.0786
Profi-jet 180 D		•				•				
Quadro 9/170 TST		•					•			
Quadro 11/140 TST		•						•		
Quadro 12/150 TST		•						•		
Quadro 599 TST		•						•		
Quadro 799 TST		•						•		
Quadro 800 TST	•								•	
Quadro 1000 TS	•								•	
Quadro 1000 TST	•								•	
Quadro 1200 TS	•								•	
Quadro 1200 TST	•								•	
THERM 600 E		•						•		
THERM 601 E		•						•		
THERM 630		•						•		
THERM 635		•						•		
THERM 750		•						•		
THERM 755		•						•		
THERM 870		•						•		
THERM 890	•								•	
THERM 895	•								•	
THERM 900 E		•						•		
THERM 1160		•						•		
THERM 1165		•						•		
THERM C 11/130		•						•		
THERM C 13/180		•						•		
THERM C 15/150		•						•		
THERM CA 11/130		•						•		
THERM CA 12/150		•						•		
W11/135		•						•		
W13/230		•						•		
W15/200		•						•		
W19/160		•						•		

ZX.0790	ZX.0791	ZX.0792	ZX.0793
Kit Dolly SP1 valves + O-Rings	Kit Dolly SP2 valves + O-Rings	Kit Dolly SP3 valves + O-Rings	Kit Dolly SP4 valves + O-Rings
			
gr. 70 oz. 2.5	gr. 110 oz. 3.9	gr. 70 oz. 2.5	gr. 145 oz. 5.2
quantity 2x6	quantity 5x6	quantity 3x6	quantity 2x6



ZX.0799	ZX.0794	ZX.0800	ZX.0795
Kit Dolly SP10 seal packing ø16	Kit Dolly SP5 seal packing ø18	Kit Dolly SP11 seal packing ø18 <i>Without O-Ring for case, with leakage recirculation</i>	Kit Dolly SP6 seal packing ø18
			
gr. 25 oz. 0.9	gr. 25 oz. 0.9	gr. 20 oz. 0.8	gr. 25 oz. 0.9
quantity 5x3	quantity 6x3	quantity 4x3	quantity 6x3

ZX.0796	ZX.0797	ZX.0798
Kit Dolly SP7 seal packing ø18	Kit Dolly SP8 seal packing ø18	Kit Dolly SP9 seal packing ø18
		
gr. 30 oz. 1.1	gr. 30 oz. 1.1	gr. 35 oz. 1.3
quantity 5x3	quantity 6x3	quantity 6x3

CDR.0684	CDR.0685	CDR.0686
Dolly SP12 ceramic plunger ø18x39	Dolly SP13 ceramic plunger ø20x39	Dolly SP14 ceramic plunger ø16x39
 11 mm 39 mm 18 mm	 11 mm 39 mm 20 mm	 11 mm 39 mm 16 mm
gr. 25 oz. 0.9	gr. 35 oz. 1.3	gr. 20 oz. 0.8
quantity 1	quantity 1	quantity 1

CDR.0687	CDR.0690
Dolly SP15 ceramic plunger ø18x32,5	Dolly SP16 ceramic plunger ø18x45
 11 mm 32,5 mm 18 mm	 11 mm 45 mm 18 mm
gr. 20 oz. 0.8	gr. 35 oz. 1.3
quantity 1	quantity 1





For pumps fitting Speck	Valves				Seal packing				Plungers							
	ZX.0790	ZX.0791	ZX.0792	ZX.0793	ZX.0799	ZX.0794	ZX.0800	ZX.0795	ZX.0796	ZX.0797	ZX.0798	CDR.0684	CDR.0685	CDR.0686	CDR.0687	CDR.0690
P10/13-100	•					•	•					•				
P10/15-130	•					•	•					•				
P11/10-100	•					•	•					•				
P11/13-100	•					•	•					•				
P11/15-150	•					•	•					•				
P11/10-100 D												•				
P11/13-100 D												•				
P11/15-150 D												•				
P21/5-450		•														
P21/7-400		•														
P21/15-160	•						•					•				
P21/16-200	•					•								•		
P21/18-130	•													•		
P21/23-130	•													•		
P21/18-130 D														•		
P21/23-130 D														•		
P22/15-280															•	
NP10/10-140		•							•							•
NP10/13-140		•							•							•
NP10/15-140		•							•							•
NP16/14-210	•									•						•
NP16/15-210	•									•						•
NP16/18-140	•															•
NP16/21-140	•															•
NP25/21-280		•									•					•
NP25/21-350		•									•					•
NP25/25-220		•									•					•





<p>ZX.0780</p> <p>Kit Dolly L2 valves + O-Rings</p> 		<p>ZX.0801</p> <p>Kit Dolly L2/A valves + O-Rings</p> 	
gr. 30 oz. 1.1	quantity 2x6	gr. 30 oz. 1.1	quantity 4x3

<p>ZX.0779</p> <p>Kit Dolly L34 valves + O-Rings</p> 		<p>ZX.0802</p> <p>Kit Dolly L74 valves + O-Rings</p> 		<p>ZX.0806</p> <p>Kit Dolly L108 valves + O-Rings</p> 	
gr. 30 oz. 1.1	quantity 2x6	gr. 30 oz. 1.1	quantity 4x3	gr. 45 oz. 1.6	quantity 2x6

<p>ZX.0223</p> <p>Kit Dolly L3 h.p. seals ø15x22</p> 		<p>ZX.0529</p> <p>Set Dolly L3-60HP h.p. seals ø15x22</p> 	
gr. 15 oz. 0.6	quantity 1x6	gr. 80 oz. 2.9	quantity 1x60

For pumps fitting	Valves					Seal packing			Oil seals		
	ZX.0780	ZX.0801	ZX.0779	ZX.0802	ZX.0806	ZX.0223	ZX.0222	ZX.0777	ZX.0803	ZX.0812	ZX.0726
LAVOR:											
BEST	•					•					•
EAGLE 21/26 (brass head)				•				•			•
EQ 21 (brass head)				•				•			•
FXK 1321				•				•			•
JET FIRE 1000	•					•					•
JOLLY 4					•				•		•
JOLLY 5					•				•		•
KARJET (KJ) BEST	•					•					•
KARJET (KJ) OMNIA		•				•					•
KLEANER (KN) (brass head)				•				•			•
KW (SPACE)		•				•					•
LASER (LS)		•				•					•
LAVORJET	•					•					•
LKX					•				•		•
LMX					•				•		•
LW	•					•					•
LWX 1400			•				•				•
LWX 1500			•				•				•
NPX 4					•				•		•
NPX 1400					•				•		•
NPX 1500					•				•		•
OMNIA		•				•					•
THERMIC 5				•				•			•
THERMIC 5/S				•				•			•
VULKER		•					•				•
FASA:											
FA-SA ARTIC						•			•		•
FA-SA KURSAL	•						•				•
FA-SA SUNDEK						•			•		•
FA-SA TANGO	•						•				•

<p>ZX.0222</p> <p>Kit Dolly L33 seal packing ø15</p> 		<p>ZX.0529</p> <p>Set Dolly L3-60HP h.p. seals ø15x22</p> 		<p>ZX.0528</p> <p>Set Dolly L33-60LP l.p. seals ø15x25</p> 		<p>ZX.0777</p> <p>Kit Dolly L66 h.p. seals ø14x22</p> 		<p>ZX.0947</p> <p>Set Dolly L66-60HP h.p. seals ø14x22</p> 	
gr. 20 oz. 0.8	quantity 2x3	gr. 80 oz. 2.9	quantity 1x60	gr. 150 oz. 5.3	quantity 1x60	gr. 15 oz. 0.6	quantity 1x3	gr. 100 oz. 3.6	quantity 1x60

<p>ZX.0803</p> <p>Kit Dolly L109 seal packing ø15</p> 		<p>ZX.0529</p> <p>Set Dolly L3-60HP h.p. seals ø15x22</p> 		<p>ZX.0948</p> <p>Set Dolly L109-60HP h.p. seals ø15x24</p> 		<p>ZX.0812</p> <p>Kit Dolly L5 plunger oil seals ø15x25,4x5/7</p> 		<p>ZX.0726</p> <p>Kit Dolly L19 plunger oil seals ø14x22x5/7</p> 	
gr. 20 oz. 0.8	quantity 4x3	gr. 80 oz. 2.9	quantity 1x60	gr. 110 oz. 3.9	quantity 1x60	gr. 20 oz. 0.8	quantity 1x3	gr. 20 oz. 0.8	quantity 1x3

ZX.0781 Kit Dolly L20 valves + O-Rings	ZX.0122 Kit Dolly L18 h.p. seals ø14x22	ZX.0527 Set Dolly L18-60HP h.p. seals ø14x22	ZX.0807 Kit Dolly L124 h.p. seals ø12x18	ZX.0957 Set Dolly L124-60HP h.p. seals ø12x18
				
gr. 20 oz. 0.8	gr. 15 oz. 0.6	gr. 80 oz. 2.9	gr. 15 oz. 0.6	gr. 60 oz. 2.2
quantity 4x3	quantity 1x3	quantity 1x60	quantity 1x3	quantity 1x60
ZX.0804 Kit Dolly L132 h.p. seals ø12x18	ZX.0958 Set Dolly L132-60HP h.p. seals ø12x18	ZX.0726 Kit Dolly L19 plunger oil seals ø14x22x5/7	ZX.0805 Kit Dolly L79 plunger oil seals ø12x20x5/7	
				
gr. 15 oz. 0.6	gr. 70 oz. 2.5	gr. 20 oz. 0.8	gr. 15 oz. 0.6	
quantity 1x3	quantity 1x60	quantity 1x3	quantity 1x3	



For pumps fitting	Valves		Seal packing			Oil seals	
	ZX.0781	ZX.0122	ZX.0807	ZX.0804	ZX.0726	ZX.0805	
LAVOR:							
BEST 24			•			•	
BEST 28	•			•		•	
BI-CLEANER			•			•	
COBRA 19			•			•	
COBRA 20			•			•	
COBRA 130			•			•	
DERBY			•			•	
DOLPHIN	•	•			•		
DOUBLE-PR			•			•	
DX	•		•			•	
DX '03			•			•	
EAGLE 20	•	•			•		
EAGLE 24	•		•			•	
EAGLE 28	•		•	•		•	
ED			•			•	
EKO			•			•	
EQ	•	•			•		
FALCON	•	•			•		
FALCON ø12	•		•			•	
FKX 1018	•		•			•	
FKX 1123	•		•			•	
GT	•	•			•		
HAPPY			•			•	
HIPPOJET (HJ)	•	•			•		
HW	•		•			•	
HW 28	•		•	•		•	
JD			•			•	
JET			•			•	
JET POWER (JP)	•	•			•		
JOKER (JK)	•	•			•		
KD			•			•	
KLEANER (KN) (aluminium head)	•	•			•		
For pumps fitting							
KOALA	•		•			•	
KS	•		•			•	
KS ø12	•		•			•	
LD	•		•			•	
LD 28	•		•		•	•	
LP	•	•			•	•	
LW 1400 S			•			•	
MACH	•		•			•	
MACH 20 '03			•			•	
MACH 28	•		•			•	
MF			•			•	
MISSOURI	•		•			•	
MODULO (MD)	•	•			•		
NOVAK	•	•			•		
PARANA'	•		•		•	•	
PARTNER	•	•			•	•	
PJ POWER JET 24	•		•			•	
PJ POWER JET 28	•		•		•	•	
POWER 13			•			•	
POWER 15			•			•	
POWER 17			•			•	
RIO 1123	•		•			•	
SD			•			•	
SKANER (SK)	•	•			•	•	
SONIC			•			•	
SPARK (SP)	•	•			•	•	
SUN			•			•	
TANKER (TK)	•	•			•	•	
TD			•			•	
TECNICA 130	•	•			•	•	
TF			•			•	
THERMIC 3/S	•	•			•	•	
TIGER	•		•			•	
TIGER '03			•			•	
TURTLE	•		•			•	
For pumps fitting							
VIPER '03						•	
VIPER ø12	•		•			•	
VIPER ø14	•	•				•	
WASHER 15			•			•	
WASHER 17			•			•	
WASHER 19			•			•	
WP	•	•				•	
WP '03			•			•	
WP ø12	•		•			•	
YUKON	•			•		•	
FASA:							
FA-SA AVANT	•		•			•	
FA-SA CHRONO	•		•			•	
FA-SA CHRONO '03			•			•	
FA-SA COUNTRY	•		•			•	
FA-SA DANCE			•			•	
FA-SA EXXEL20	•		•			•	
FA-SA EXXEL20 '03			•			•	
FA-SA FUNKY	•	•				•	
FA-SA HIPPO	•	•				•	
FA-SA JAZZ			•			•	
FA-SA KAIMAN	•		•			•	
FA-SA KAPPA A	•		•			•	
FA-SA KAPPA A '03			•			•	
FA-SA KAPPA 100	•	•				•	
FA-SA KLIMAT 120	•		•			•	
FA-SA KLIMAT 150	•		•			•	
FA-SA LEADER			•			•	
FA-SA ROCK 28	•		•			•	
FA-SA SAMBA 19			•			•	
FA-SA SOUL			•			•	
FA-SA SWING	•		•			•	



<p>ZX.0904 Kit Dolly U1 valves + O-Rings</p>  <p>gr. 70 oz. 2.5</p> <p>quantity 2x6</p>	<p>ZX.0896 Kit Dolly U7 seal packing ø15</p>  <p>gr. 30 oz. 1.1</p> <p>quantity 4x3</p>	<p>ZX.0897 Kit Dolly U8 seal packing ø18</p>  <p>gr. 30 oz. 1.1</p> <p>quantity 4x3</p>
<p>ZX.0912 Kit Dolly U18 plunger oil seals ø15x24x5</p>  <p>gr. 25 oz. 0.9</p> <p>quantity 1x3</p>	<p>ZX.0920 Dolly U24 shaft oil seal ø40x52x7</p>  <p>gr. 20 oz. 0.8</p> <p>quantity 1</p>	<p>ZX.0918 Dolly U54 shaft oil seal ø25x52x10</p>  <p>gr. 35 oz. 1.3</p> <p>quantity 1</p>
<p>CDR.0880 Dolly U35 ceramic plunger ø15x30</p>  <p>30 mm</p> <p>9 mm</p> <p>15 mm</p> <p>gr. 15 oz. 0.6</p> <p>quantity 1</p>	<p>CDR.0882 Dolly U36 ceramic plunger ø18x30</p>  <p>30 mm</p> <p>9 mm</p> <p>18 mm</p> <p>gr. 20 oz. 0.8</p> <p>quantity 1</p>	

For pumps fitting Udor: PNC-PND PNE-PNL series	Valves		Seal packing		Oil seals			Plungers	
	Kit Dolly U1 ZX.0904	Kit Dolly U7 ZX.0896	Kit Dolly U8 ZX.0897	Kit Dolly U18 ZX.0912	Kit Dolly U24 ZX.0920	Kit Dolly U54 ZX.0918	Dolly U35 CDR.0880	Dolly U36 CDR.0882	
PNC 09/11 S	•	•		•		•	•		
PNC 09/15 S	•	•		•		•	•		
PNC 11/11 S	•		•	•		•		•	
PNC 13/12 S	•		•	•		•		•	
PNC 13/15 S	•		•	•		•		•	
PNC 13/17 S	•		•	•		•		•	
PND 2.0/20 S	•	•		•		•	•		
PND 2.0/20 Z	•	•		•	•		•		
PND 3.0/20 S	•	•		•		•	•		
PND 3.0/20 Z	•	•		•	•		•		
PND 3.0/25 S	•	•		•		•	•		
PND 3.5/20 S	•		•	•		•		•	
PND 3.5/20 Z	•		•	•	•			•	
PND 3.5/25 S	•		•	•		•		•	
PND 4.0/20 S	•		•	•		•		•	
PND 4.0/20 Z	•		•	•	•			•	
PNE 09/11 S	•	•		•		•	•		
PNE 11/11 S	•	•		•		•	•		
PNE 13/12 S	•	•		•		•	•		
PNE 13/15 S	•	•		•		•	•		
PNL 2.0/20 T	•	•		•	•		•		
PNL 3.0/20 T	•	•		•	•		•		
PNL 3.0/25 T	•	•		•	•		•		
PNL 3.0/25 T	•	•		•	•		•		
PNL 3.5/22 T	•	•		•	•		•		

<p>ZX.0905 Kit Dolly U2 valves + O-Rings</p>  <p>gr. 70 oz. 2.5</p> <p>quantity 2x6</p>	<p>ZX.0908 Kit Dolly U30 valves + O-Rings</p>  <p>gr. 80 oz. 2.9</p> <p>quantity 2x6</p>	<p>ZX.0896 Kit Dolly U7 seal packing ø15</p>  <p>gr. 30 oz. 1.1</p> <p>quantity 4x3</p>
<p>ZX.0902 Kit Dolly U28 seal packing ø18</p>  <p>gr. 30 oz. 1.1</p> <p>quantity 4x3</p>	<p>ZX.0898 Kit Dolly U9 seal packing ø20</p>  <p>gr. 30 oz. 1.1</p> <p>quantity 4x3</p>	<p>ZX.0913 Kit Dolly U39 plunger oil seals ø18x30x7</p>  <p>gr. 25 oz. 0.9</p> <p>quantity 1x3</p>
		<p>ZX.0914 Kit Dolly U52 plunger oil seals ø18x30x7*</p>  <p>*Manufactured with different material</p> <p>gr. 25 oz. 0.9</p> <p>quantity 1x3</p>



ZX.0916	ZX.0921
Dolly U40 shaft oil seal ø25x52x7	Dolly U41 shaft oil seal ø40x55x7
	
gr. 25 oz. 0.9	gr. 25 oz. 0.9
quantity 1	quantity 1

ZX.0917	CDR.0880
Dolly U51 shaft oil seal ø25x52x7*	Dolly U35 ceramic plunger ø15x30
	
gr. 25 oz. 0.9	gr. 15 oz. 0.6
quantity 1	quantity 1

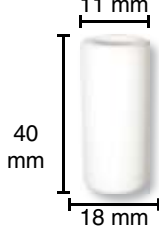
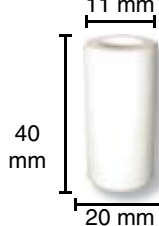
CDR.0883	CDR.0884
Dolly U30 ceramic plunger ø18x40	Dolly U31 ceramic plunger ø20x40
	
gr. 25 oz. 0.9	gr. 35 oz. 1.3
quantity 1	quantity 1

For pumps fitting Udor: MC-MCW MD-ME-ML MKC-MKL series	Valves		Seal packing		Oil seals			Plungers					
	Kit Dolly U2 ZX.0905	Kit Dolly U30 ZX.0908	Kit Dolly U7 ZX.0896	Kit Dolly U28 ZX.0902	Kit Dolly U9 ZX.0898	Kit Dolly U39 ZX.0913	Kit Dolly U52 ZX.0914	Kit Dolly U40 ZX.0916	Kit Dolly U41 ZX.0921	Kit Dolly U51 ZX.0917	Dolly U35 CDR.0880	Dolly U30 CDR.0883	Dolly U31 CDR.0884
MC 13/20 I	•			•		•			•			•	
MC 13/20 S	•			•		•		•				•	
MC 15/15 S	•			•		•		•				•	
MC 15/20 I	•			•		•		•				•	
MC 15/20 S	•			•		•		•				•	
MC 18/20 S	•			•	•	•		•				•	•
MC 20/15 S	•			•	•	•		•				•	•
MC 20/20 S	•			•	•	•		•				•	•
MCW 16/14 S	•			•	•	•	•	•		•		•	•
MD 4.0/20 S	•			•	•	•		•				•	•
MD 4.0/20 U	•			•	•	•		•				•	•
MD 4.0/30 S	•			•	•	•		•				•	•
MD 4.0/30 U	•			•	•	•		•				•	•
MD 5.0/30 S	•			•	•	•		•				•	•
MD 5.0/30 U	•			•	•	•		•				•	•
ME 15/20 S	•			•	•	•		•				•	•
ML 3.5/30 W	•			•	•	•		•				•	•
ML 4.0/30 W	•			•	•	•		•				•	•
ML 5.0/30 W	•			•	•	•		•				•	•
MKC 13/28 S		•		•	•	•		•				•	•
MKC 15/24 S		•		•	•	•		•				•	•
MKC 15/28 S		•		•	•	•		•				•	•
MKC 18/24 S		•		•	•	•		•				•	•
MKC 20/24 S		•		•	•	•		•				•	•
MKL 4.0/35 W		•	•		•	•		•			•		•
MKL 4.0/40 W		•	•		•	•		•			•		•
MKL 5.0/35 W		•	•		•	•		•			•		•

ZX.0906	ZX.0910
Kit Dolly U3 valves + O-Rings	Kit Dolly U41 valves + O-Rings
	
gr. 75 oz. 2.7	gr. 175 oz. 6.2
quantity 2x6	quantity 3x6





ZX.0911	ZX.0903
Kit Dolly U86 valves + O-Rings	Kit Dolly U88 seal packing ø15
	
gr. 175 oz. 6.2	gr. 30 oz. 1.1
quantity 1x3 3x3	quantity 5x3

For pumps fitting Udor: GHC-GHD GKC-GKD series	Valves		Seal packing		Oil seals			Plungers			
	Kit Dolly U3 ZX.0906	Kit Dolly U41 ZX.0910	Kit Dolly U86 ZX.0911	Kit Dolly U88 ZX.0903	Kit Dolly U9 ZX.0898	Kit Dolly U10 ZX.0899	Kit Dolly U43 ZX.0915	Kit Dolly U38 ZX.0919	Dolly U45 CDR.0881	Dolly U31 CDR.0884	Dolly U32 CDR.0879
GHC 12/50 S			•	•			•	•	•		
GHC 16/50 S			•	•			•	•	•		
GHD 3.0/75 S			•	•			•	•	•		
GHD 4.5/75 S			•	•			•	•	•		
GKC 17/28 S	•					•	•	•			•
GKC 17/35 S		•			•		•	•		•	
GKC 19/40 S					•		•	•		•	
GKC 21/28 S	•					•	•	•			•
GKC 21/35 S		•			•		•	•		•	
GKC 26/28 S	•					•	•	•			•
GKD 4.5/50 S		•			•		•	•		•	
GKD 5.5/40 S		•			•		•	•		•	
GKD 6.0/50 S		•			•		•	•		•	
GKD 7.0/40 S	•					•	•	•			•



For pumps - Fitting Udor GHC-GHD-GKC-GKD series



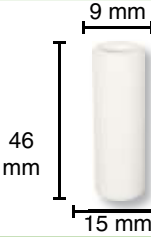
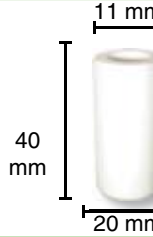
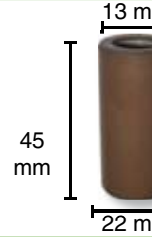



Dolly Spare Parts® are Club dei Riparatori® by IDROBASE® products.

ZX.0898 Kit Dolly U9 seal packing ø20  gr. 30 oz. 1.1 quantity 4x3		ZX.0899 Kit Dolly U10 seal packing ø22  gr. 40 oz. 1.5 quantity 4x3		ZX.0915 Kit Dolly U43 plunger oil seals ø22x32x7  gr. 25 oz. 0.9 quantity 1x3		ZX.0919 Kit Dolly U38 shaft oil seals ø30x52x7  gr. 25 oz. 0.9 quantity 1	
CDR.0881 Dolly U45 ceramic plunger ø15x46  gr. 20 oz. 0.8 quantity 1		CDR.0884 Dolly U31 ceramic plunger ø20x40  gr. 35 oz. 1.3 quantity 1		CDR.0879 Dolly U32 ceramic plunger ø22x45  gr. 45 oz. 1.6 quantity 1			

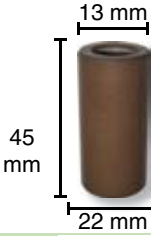
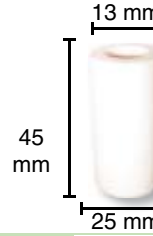

For pumps - Fitting Udor GB-GC-GD series

Dolly Spare Parts® are Club dei Riparatori® by IDROBASE® products.

ZX.0909 Kit Dolly U31 valves + O-Rings  gr. 140 oz. 5.0 quantity 2x6		ZX.0899 Kit Dolly U10 seal packing ø22  gr. 40 oz. 1.5 quantity 4x3		For pumps fitting Udor: GB-GC-GD series <table border="1"> <thead> <tr> <th></th> <th>Valves</th> <th colspan="4">Seal packing</th> <th colspan="3">Oil seals</th> <th colspan="2">Plungers</th> </tr> <tr> <th></th> <th>Kit Dolly U31 ZX.0909</th> <th>Kit Dolly U10 ZX.0899</th> <th>Kit Dolly U11 ZX.0900</th> <th>Kit Dolly U12 ZX.0901</th> <th>Kit Dolly U43 ZX.0915</th> <th>Kit Dolly U38 ZX.0919</th> <th>Dolly U32 CDR.0879</th> <th>Dolly U33 CDR.0886</th> <th>Dolly U34 CDR.0887</th> </tr> </thead> <tbody> <tr><td>GB 21/20 S</td><td>•</td><td></td><td>•</td><td></td><td>•</td><td>•</td><td></td><td>•</td><td></td></tr> <tr><td>GB 26/20 S</td><td>•</td><td></td><td></td><td>•</td><td>•</td><td>•</td><td></td><td></td><td>•</td></tr> <tr><td>GB 30/20 S</td><td>•</td><td></td><td></td><td>•</td><td>•</td><td>•</td><td></td><td></td><td>•</td></tr> <tr><td>GB 34/20 S</td><td>•</td><td></td><td></td><td>•</td><td>•</td><td>•</td><td></td><td></td><td>•</td></tr> <tr><td>GC 21/20 S</td><td></td><td>•</td><td></td><td></td><td>•</td><td>•</td><td>•</td><td></td><td></td></tr> <tr><td>GC 26/20 S</td><td>•</td><td>•</td><td></td><td></td><td>•</td><td>•</td><td>•</td><td></td><td></td></tr> <tr><td>GC 30/20 S</td><td>•</td><td></td><td>•</td><td></td><td>•</td><td>•</td><td></td><td>•</td><td></td></tr> <tr><td>GC 34/17 S</td><td>•</td><td></td><td>•</td><td></td><td>•</td><td>•</td><td></td><td>•</td><td></td></tr> <tr><td>GC 38/15 S</td><td>•</td><td></td><td></td><td>•</td><td>•</td><td>•</td><td></td><td></td><td>•</td></tr> <tr><td>GC 42/14 S</td><td>•</td><td></td><td></td><td>•</td><td>•</td><td>•</td><td></td><td></td><td>•</td></tr> <tr><td>GC 50/12 S</td><td>•</td><td></td><td></td><td>•</td><td>•</td><td>•</td><td></td><td></td><td>•</td></tr> <tr><td>GD 5.5/30 S</td><td>•</td><td>•</td><td></td><td></td><td>•</td><td>•</td><td>•</td><td></td><td></td></tr> <tr><td>GD 7.0/30 S</td><td>•</td><td>•</td><td></td><td></td><td>•</td><td>•</td><td>•</td><td></td><td></td></tr> <tr><td>GD 8.5/30 S</td><td>•</td><td>•</td><td></td><td></td><td>•</td><td>•</td><td>•</td><td></td><td></td></tr> </tbody> </table>			Valves	Seal packing				Oil seals			Plungers			Kit Dolly U31 ZX.0909	Kit Dolly U10 ZX.0899	Kit Dolly U11 ZX.0900	Kit Dolly U12 ZX.0901	Kit Dolly U43 ZX.0915	Kit Dolly U38 ZX.0919	Dolly U32 CDR.0879	Dolly U33 CDR.0886	Dolly U34 CDR.0887	GB 21/20 S	•		•		•	•		•		GB 26/20 S	•			•	•	•			•	GB 30/20 S	•			•	•	•			•	GB 34/20 S	•			•	•	•			•	GC 21/20 S		•			•	•	•			GC 26/20 S	•	•			•	•	•			GC 30/20 S	•		•		•	•		•		GC 34/17 S	•		•		•	•		•		GC 38/15 S	•			•	•	•			•	GC 42/14 S	•			•	•	•			•	GC 50/12 S	•			•	•	•			•	GD 5.5/30 S	•	•			•	•	•			GD 7.0/30 S	•	•			•	•	•			GD 8.5/30 S	•	•			•	•	•		
	Valves	Seal packing				Oil seals			Plungers																																																																																																																																																													
	Kit Dolly U31 ZX.0909	Kit Dolly U10 ZX.0899	Kit Dolly U11 ZX.0900			Kit Dolly U12 ZX.0901	Kit Dolly U43 ZX.0915	Kit Dolly U38 ZX.0919	Dolly U32 CDR.0879	Dolly U33 CDR.0886	Dolly U34 CDR.0887																																																																																																																																																											
GB 21/20 S	•		•				•	•		•																																																																																																																																																												
GB 26/20 S	•					•	•	•			•																																																																																																																																																											
GB 30/20 S	•					•	•	•			•																																																																																																																																																											
GB 34/20 S	•					•	•	•			•																																																																																																																																																											
GC 21/20 S		•					•	•	•																																																																																																																																																													
GC 26/20 S	•	•					•	•	•																																																																																																																																																													
GC 30/20 S	•		•				•	•		•																																																																																																																																																												
GC 34/17 S	•		•		•	•		•																																																																																																																																																														
GC 38/15 S	•			•	•	•			•																																																																																																																																																													
GC 42/14 S	•			•	•	•			•																																																																																																																																																													
GC 50/12 S	•			•	•	•			•																																																																																																																																																													
GD 5.5/30 S	•	•			•	•	•																																																																																																																																																															
GD 7.0/30 S	•	•			•	•	•																																																																																																																																																															
GD 8.5/30 S	•	•			•	•	•																																																																																																																																																															
ZX.0900 Kit Dolly U11 seal packing ø25  gr. 45 oz. 1.6 quantity 4x3		ZX.0901 Kit Dolly U12 seal packing ø28  gr. 50 oz. 1.8 quantity 4x3		CDR.0879 Dolly U32 ceramic plunger ø22x45  gr. 45 oz. 1.6 quantity 1		CDR.0886 Dolly U33 ceramic plunger ø25x45  gr. 60 oz. 2.2 quantity 1		CDR.0887 Dolly U34 ceramic plunger ø28x45  gr. 85 oz. 3.1 quantity 1																																																																																																																																																														

BEFORE...



...AFTER

ZX.0724

Set Dolly X891
for pumps
fitting Kärcher
ø14























gr. 155
oz. 5.5

IMPORTANT !

Each set includes all items below mentioned, quantities are indicated by the number of pieces (in brackets).

Additionally each item included in the set can be sold individually, even 1 piece using the corresponding reference.

<p>ZX.0462</p> <p>Complete valve</p>  <p>(6 pcs per set)</p>	<p>CDR.0918</p> <p>Complete valve</p>  <p>(1 pc per set)</p>	<p>CDR.0921</p> <p>Complete valve</p>  <p>(1 pc per set)</p>	<p><i>For h.p. washers pumps fitting Kärcher</i></p> <p>H 2500</p> <p>HDS 2.3/13 C ED</p> <p>HDS 7/13 C *J</p> <p>HDS 558 C</p> <p>HDS 558 C *CDN</p> <p>HDS 558 C ECO</p> <p>HDS 558 CSX</p> <p>HDS 698 C</p> <p>HDS 698 C *J</p> <p>HDS 698 C ECO</p> <p>HDS 698 CSX</p> <p>ST HDS 558 *GB</p>
<p>CDR.0919</p> <p>Valve plate</p>  <p>(1 pc per set)</p>	<p>CDR.0920</p> <p>Plastic fork</p>  <p>(2 pcs per set)</p>	<p>GUA.0001</p> <p>White Disc ø14</p>  <p>(3 pcs per set)</p>	
<p>CDR.0655</p> <p>Brass disc ø14</p>  <p>(3 pcs per set)</p>	<p>CDR.0657</p> <p>Disc</p>  <p>(2 pcs per set)</p>	<p>CDR.0941</p> <p>Valve rod</p>  <p>(1 pc per set)</p>	
<p>CDR.0923</p> <p>O-Ring</p>  <p>(1 pc per set)</p>	<p>CDR.0924</p> <p>O-Ring</p>  <p>(1 pc per set)</p>	<p>ZX.0962</p> <p>O-Ring</p>  <p>(2 pcs per set)</p>	
<p>ZX.0963</p> <p>O-Ring</p>  <p>(1 pc per set)</p>	<p>CDR.0907</p> <p>O-Ring</p>  <p>(6 pcs per set)</p>	<p>CDR.0913</p> <p>O-Ring</p>  <p>(2 pcs per set)</p>	
<p>CDR.0929</p> <p>O-Ring</p>  <p>(6 pcs per set)</p>	<p>CDR.0471</p> <p>Plunger oil seal ø14</p>  <p>(3 pcs per set)</p>	<p>CDR.0205</p> <p>H.p. seal ø14</p>  <p>(3 pcs per set)</p>	<p>CDR.0942</p> <p>O-Ring for packing retainer</p>  <p>(3 pcs per set)</p> <p>CDR.0943</p> <p>O-Ring for carter</p>  <p>(1 pc per set)</p> <p>CDR.0200</p> <p>L.p. seal ø14</p>  <p>(3 pcs per set)</p>

ZX.0720

Set Dolly X172
for pumps
fitting Kärcher
ø18



gr. 125
oz. 4.5

IMPORTANT !

Each set includes all items below mentioned, quantities are indicated by the number of pieces (in brackets).

Additionally each item included in the set can be sold individually, even 1 piece using the corresponding reference.

*For h.p. washers pumps
fitting Kärcher*

H 2700	HDS 795 JAPAN
HDS 555 CS	HDS 797 CI
HDS 590 C	HDS 797 CI *J
HDS 600 C *VEX	HDS 797 CI *VEX
HDS 600 C (290)	HDS 890 C *CH
HDS 600 C (340)	HDS 890 C *GB/AUS
HDS 600 C SPEZ.	HDS 890 C *VEX
HDS 600 CI	HDS 890 C (360)
HDS 600 CI *EUR	HDS 890 C (480) *J
HDS 600 CS (150)	HDS 890 C (490) *J
HDS 600 CS (340)	HDS 890 C (550)
HDS 655 *GB	HDS 895 (350)
HDS 695	HDS 895 (460)
HDS 790 C	HDS 895 SPECIAL
HDS 790 CI *J	HDS 900 C *USA/CD
HDS 790 CI *EUR	HYDRO LAV *BR
HDS 790 CS	SB-HDS 695
HDS 790 CS *CH	SB-HDS 695 WERT
HDS 790 CS *EUR	SB-HDW
HDS 790 CS *EURO	1500 SUPER *EUR
HDS 790 CS *SF	
HDS 790 CS *VEX	

ZX.0462



Complete
valve

(6 pcs per set)

GUA.0006



Disco
ø18

(3 pcs per set)

CDR.0931



O-Ring

(3 pcs per set)

CDR.0924



O-Ring

(1 pc per set)

CDR.0932



O-Ring
for cover

(1 pc per set)

CDR.0933



O-Ring
for screw
cover

(3 pcs per set)

CDR.0934



O-Ring

(1 pc per set)

CDR.0935



O-Ring
for
packing
retainer

(3 pcs per set)

ZX.0964



O-Ring

(2 pcs per set)

CDR.0908



O-Ring

(1 pc per set)

ZX.0965



O-Ring

(1 pc per set)

CDR.0940



O-Ring
for carter

(1 pc per set)

CDR.0201



L.p.
seal
ø18

(3 pcs per set)

CDR.0207



H.p.
seal
ø18

(3 pcs per set)

CDR.0472



Plunger
oil seal
ø18

(3 pcs per set)

HYDROEAST

**COMPONENTS
TO
MANUFACTURE
HIGH
PRESSURE
WASHERS**

www.hydroeast.cn

ZX.0723

Set Dolly X322
for pumps
fitting Kärcher
ø20



gr. 215
oz. 7.6

IMPORTANT !

Each set includes all items below mentioned, quantities are indicated by the number of pieces (in brackets).

Additionally each item included in the set can be sold individually, even 1 piece using the corresponding reference.

ZX.0463



Complete
valve

(5 pcs per set)

ZX.0452



Complete
valve

(2 pcs per set)

ZX.0451



Complete
valve

(1 pc per set)

*For h.p. washers pumps
fitting Kärcher*

HDS 655 / 745

HDS 745

HDS 745 *GB

HDS 755

HDS 755 *GB

HDS 945 *CSA/CDN

HDS 1000

HDS 1055 *CDN

HDS 1055 *USA

HDS 2245

HDS 3005

MODUL - AUFBAU

SB-C

SB-C 5/10-2

SB-C 1001/12

SB AB BJ2004

PK.0001



Disc
ø20

(3 pcs per set)

CDR.0904



O-Ring

(2 pcs per set)

ZX.0018



O-Ring

(1 pc per set)

CDR.0907



O-Ring

(1 pc per set)

CDR.0908



O-Ring

(1 pc per set)

CDR.0909



O-Ring for
packing
retainer
ø34,65

(3 pcs per set)

CDR.0910



O-Ring for
packing
retainer
ø36

(3 pcs per set)

ZX.0961



O-Ring

(4 pcs per set)

CDR.0913



O-Ring

(1 pc per set)

CDR.0914



O-Ring

(1 pc per set)

CDR.0915



O-Ring

(3 pcs per set)

CDR.0916



O-Ring
for carter

(1 pc per set)

CR.A1399

Dolly X1
Ceramic
plunger
ø20x35

**NOT
INCLUDED IN
THE SET**



gr. 30
oz. 1.1

quantity
1

CDR.0473



Plunger
oil seal
ø20

(3 pcs per set)

CDR.0202



L.p.
seal
ø20

(3 pcs per set)

CDR.0208



H.p.
seal
ø20

(3 pcs per set)

THEN and ...NOW



ZX.0721

Set Dolly X913
for pumps
fitting Kärcher
ø20



gr. 205
oz. 7.3

IMPORTANT !

Each set includes all items below mentioned, quantities are indicated by the number of pieces (in brackets).

Additionally each item included in the set can be sold individually, even 1 piece using the corresponding reference.

<p>ZX.0462</p> <p>Complete valve</p>  <p>(5 pcs per set)</p>	<p>CDR.0918</p> <p>Complete valve</p>  <p>(1 pc per set)</p>	<p>CDR.0921</p> <p>Complete valve</p>  <p>(1 pc per set)</p>	<p><i>For h.p. washers pumps fitting Kärcher</i></p> <p>FT 1000 TS</p> <p>HD 7/11</p> <p>HDS 3.5/30</p> <p>HDS 4.0/20</p> <p>HDS 4.5/22</p> <p>HDS 655 *EUR</p> <p>HDS 655 M ECO</p> <p>HDS 695 M ECO</p> <p>HDS 695 S *EUR</p> <p>HDS 745 *USA</p> <p>HDS 850 4M BASIC</p> <p>HDS 895 M ECO</p> <p>HDS 895 S *EUR</p> <p>HDS 895 4M ECO *CY</p> <p>HDS 945 *USA-CDN</p> <p>HDS 995 +EUR</p> <p>HDS 995 M ECO</p> <p>HDS 1000 *USA</p> <p>HDS 1055 *USA-CDN</p> <p>HDS 1155 M ECO</p> <p>HDS M ECO BENELUX</p> <p>POWER AMERICA 1540</p> <p>SB-HDS 9/15</p> <p>SB-WASH</p>			
<p>ZX.0450</p> <p>Complete valve</p>  <p>(1 pc per set)</p>	<p>CDR.0919</p> <p>Valve plate</p>  <p>(1 pc per set)</p>	<p>CDR.0920</p> <p>Plastic fork</p>  <p>(2 pcs per set)</p>				
<p>CDR.0656</p> <p>Brass disc ø20</p>  <p>(3 pcs per set)</p>	<p>PK.0001</p> <p>Black disc ø20</p>  <p>(3 pcs per set)</p>	<p>CDR.0657</p> <p>Disc</p>  <p>(2 pcs per set)</p>				
<p>CDR.0922</p> <p>Brass pin</p>  <p>(1 pc per set)</p>	<p>CDR.0923</p> <p>O-Ring</p>  <p>(1 pc per set)</p>	<p>CDR.0924</p> <p>O-Ring</p>  <p>(1 pc per set)</p>	<p>ZX.0962</p> <p>O-Ring</p>  <p>(2 pcs per set)</p>	<p>ZX.0963</p> <p>O-Ring</p>  <p>(1 pc per set)</p>		
<p>CDR.0907</p> <p>O-Ring</p>  <p>(6 pcs per set)</p>	<p>CDR.0909</p> <p>O-Ring for packing retainer</p>  <p>(3 pcs per set)</p>	<p>CDR.0913</p> <p>O-Ring</p>  <p>(2 pcs per set)</p>	<p>CDR.0916</p> <p>O-Ring for carter</p>  <p>(1 pc per set)</p>			
<p>CDR.0929</p> <p>O-Ring</p>  <p>(6 pcs per set)</p>	<p>CDR.0473</p> <p>Plunger oil seal ø20</p>  <p>(3 pcs per set)</p>	<p>CDR.0202</p> <p>L.p. seal ø20</p>  <p>(3 pcs per set)</p>	<p>CDR.0208</p> <p>H.p. seal ø20</p>  <p>(3 pcs per set)</p>			

ZX.0722

Set Dolly X302
for pumps
fitting Kärcher
ø22



gr. 170
oz. 6.0

IMPORTANT !

Each set includes all items below mentioned, quantities are indicated by the number of pieces (in brackets).

Additionally each item included in the set can be sold individually, even 1 piece using the corresponding reference.

ZX.0463



Complete
valve

(5 pcs per set)

ZX.0452



Complete
valve

(2 pcs per set)

ZX.0451



Complete
valve

(1 pc per set)

CDR.0944



Disc
ø22

(3 pcs per set)

CDR.0904



O-Ring

(2 pcs per set)

ZX.0018



O-Ring

(1 pc per set)

CDR.0907



O-Ring

(1 pc per set)

CDR.0908



O-Ring

(1 pc per set)

CDR.0909



O-Ring for
packing
retainer
ø34,65

(3 pcs per set)

CDR.0910



O-Ring for
packing
retainer
ø36

(3 pcs per set)

ZX.0961



O-Ring

(4 pcs per set)

CDR.0913



O-Ring

(1 pc per set)

CDR.0914



O-Ring

(1 pc per set)

CDR.0915



O-Ring

(3 pcs per set)

CDR.0916



O-Ring
for carter

(1 pc per set)

CDR.0209



H.p.
seal
ø22

(3 pcs per set)

CDR.0203



L.p.
seal
ø22

(3 pcs per set)

CDR.0474



Plunger
oil seal
ø22

(3 pcs per set)































*For h.p. washers pumps
fitting Kärcher*

- HD 2000**
- HD 2000 SUPER**
- HDS 9/14 ST**
- HDS 9/15 ST GAS**
- HDS 9/16 ST GAS+LPG**
- HDS 12/14 ST**
- HDS 695**
- HDS 695 PWP**
- HDS 695 S**
- HDS 891 ST**
- HDS 895**
- HDS 895 S**
- HDS 995 (700)**
- HDS 995 (770)**
- HDS 995 (430) *J**
- HDS 995 (680) *J**
- HDS 1195 *USA**
- HDS 1195 *VEX**
- HDS 1291 ST**
- HDS 1295**
- HDS 1295 *EUROPA**
- HDS 1295 *J**
- HDS 2000 SUPER**
- HDS 2245**
- HDS 3000 (210)**
- HDS 3000 (980)**
- HDS 3005**
- SB-HDW S**
- SB-HDW S 2**

Perfect Cool®

























**NATURALLY
COOLER**





www.perfectcool.it

<p>ZX.0966</p> <p>Set Dolly X329 valves + O-Rings ø18</p> <p>Ref. Set Dolly pump X891-X172-X913 code ZX.0724-ZX.0720- ZX.0721</p>   <p>gr. 315 quantity oz. 11.2 1x30</p>	<p>ZX.0967</p> <p>Set Dolly X229 valves + O-Rings ø22</p>   <p>gr. 415 quantity oz. 14.7 1x30</p>	<p>ZX.0682</p> <p>Set Dolly X48 h.p. seals ø12x20</p>   <p>gr. 20 quantity oz. 0.8 1x60</p>	<p>ZX.0641</p> <p>Set Dolly X21 h.p. seals ø14x22 (black)</p>   <p>gr. 100 quantity oz. 3.6 1x60</p>	
<p>ZX.0640</p> <p>Set Dolly X20 h.p. seals ø14x22 (brown)</p>  <p>Ref. Set Dolly pump X891 code ZX.0724</p>  <p>gr. 160 quantity oz. 5.7 1x60</p>	<p>ZX.0544</p> <p>Set Dolly X9 h.p. seals ø18x26</p>  <p>Ref. Set Dolly pump X172 code ZX.0720</p>  <p>gr. 140 quantity oz. 5.0 1x60</p>	<p>ZX.1108</p> <p>Set Dolly X17 h.p. seals ø20x28</p>  <p>Ref. Set Dolly pump X322-X913 code ZX.0723-ZX.0721</p>  <p>gr. 200 quantity oz. 7.1 1x60</p>	<p>ZX.0549</p> <p>Set Dolly X14 h.p. seals ø22x30</p>  <p>Ref. Set Dolly pump X302 code ZX.0722</p>  <p>gr. 150 quantity oz. 5.3 1x60</p>	<p>ZX.1110</p> <p>Set Dolly X50 h.p. seals ø24x34</p>   <p>gr. 230 quantity oz. 8.2 1x60</p>
<p>ZX.0649</p> <p>Set Dolly X26 l.p. seals ø14x20</p>  <p>Ref. Set Dolly pump X891 code ZX.0724</p>  <p>gr. 35 quantity oz. 1.3 1x60</p>	<p>ZX.0650</p> <p>Set Dolly X27 l.p. seals ø18x28</p>  <p>Ref. Set Dolly pump X172 code ZX.0720</p>  <p>gr. 200 quantity oz. 7.1 1x60</p>	<p>ZX.0651</p> <p>Set Dolly X28 l.p. seals ø20x30</p>  <p>Ref. Set Dolly pump X322-X913 code ZX.0723-ZX.0721</p>  <p>gr. 210 quantity oz. 7.5 1x60</p>	<p>ZX.0652</p> <p>Set Dolly X29 l.p. seals ø22x32</p>  <p>Ref. Set Dolly pump X302 code ZX.0722</p>  <p>gr. 215 quantity oz. 7.6 1x60</p>	
<p>ZX.0487</p> <p>Set Dolly X23 discs ø14x24</p>  <p>Ref. Set Dolly pump X891 code ZX.0724</p>  <p>gr. 110 quantity oz. 3.9 1x60</p>	<p>ZX.0543</p> <p>Set Dolly X8 discs ø18x28</p>  <p>Ref. Set Dolly pump X172 code ZX.0720</p>  <p>gr. 95 quantity oz. 3.4 1x60</p>	<p>ZX.0488</p> <p>Set Dolly X24 discs ø20x30</p>  <p>Ref. Set Dolly pump X322-X913 code ZX.0723-ZX.0721</p>  <p>gr. 105 quantity oz. 3.8 1x60</p>	<p>ZX.0548</p> <p>Set Dolly X13 discs ø22x32</p>  <p>Ref. Set Dolly pump X302 code ZX.0722</p>  <p>gr. 105 quantity oz. 3.8 1x60</p>	
<p>ZX.0968</p> <p>Set Dolly X340 plunger oil seals ø14x22x5/7</p>  <p>Ref. Set Dolly pump X891 code ZX.0724</p>  <p>gr. 60 quantity oz. 2.2 1x15</p>	<p>ZX.0969</p> <p>Set Dolly X333 plunger oil seals ø18x26x6/8</p>  <p>Ref. Set Dolly pump X172 code ZX.0720</p>  <p>gr. 70 quantity oz. 2.5 1x15</p>	<p>ZX.0970</p> <p>Set Dolly X052 plunger oil seals ø20x28x6/8</p>  <p>Ref. Set Dolly pump X322-X913 code ZX.0723-ZX.0721</p>  <p>gr. 75 quantity oz. 2.7 1x15</p>	<p>ZX.0971</p> <p>Set Dolly X059 plunger oil seals ø22x30x6/8</p>  <p>Ref. Set Dolly pump X302 code ZX.0722</p>  <p>gr. 90 quantity oz. 3.2 1x15</p>	

Find in the following table, according to the pump you have to service, the series and page which includes all spares necessary to service your pump.

Pumps fitting Interpump	Series	Page	Pumps fitting Interpump	Series	Page	Pumps fitting Interpump	Series	Page	Pumps fitting Generalpump	Series	Page	Pumps fitting Generalpump	Series	Page
EH1413	63	140	W170	44	127	WW55	51	137	T61	76	142	TS1331	47	129
EH1416	63	140	W201	47	129	WW56	51	137	T81	76	142	TS1351	48	129
EH2009	63	140	W203	48	129	WW74	51	137	T121	77	142	TS1371	50	134
EH2011	63	140	W355	62	139	WW75	51	137	T151	77	142	TS1491	50	134
EL1411	63	140	W425	61	139	WW90	51	137	T521	49	134	TS1511	47	129
EL1413	63	140	W912	47	129	WW93	51	137	T531	49	134	TS1521	47	129
EL1714	63	140	W913	47	129	WW94	51	137	T701	50	134	TS1531	69	141
EL2007	63	140	W916	47	129	WW95	51	137	T711	50	134	TS1621	47	132
EL2009	63	140	W921	47	129	WW116	44	127	T721	49	134	TS1711	47	129
UH2008	63	140	W950	44	127	WW136	44	127	T731	49	134	TS2011	47	129
UH2011	63	140	W951	44	127	WW141	50	134	T911	50	134	TS2021	47	129
UH2013	63	140	W952	44	127	WW156	44	127	T921	47	132	TT551	51	137
UH2016	63	140	W953	44	127	WW161	50	134	T981	50	134	TT561	51	137
UL1413	63	140	W954	44	127	WW176	44	127	T991	50	134	TT741	51	137
UL1415	63	140	W955	44	127	WW186	44	127	T1011	47	129	TT751	51	137
UL2009	63	140	W956	44	127	WW189	44	127	T1209	51	137	TT901	51	137
UL2011	63	140	W957	44	127	WW206	44	127	T1212	51	137	TT931	51	137
W6	76	142	W958	44	127	WW209	44	127	T1311	47	129	TT941	51	137
W8	76	142	W959	49	134	WW906	51	137	T1321	47	132	TT951	51	137
W12	77	142	W972	49	134	WW907	51	137	T1508	51	137	TT1411	50	134
W15	77	142	W973	49	134	WW909	51	137	T1511	47	129	TT1508	51	137
W52	49	134	W979	49	134	WW935	50	134	T1551	76	142	TT1510	51	137
W53	49	134	W995	50	134	WW944	50	134	T1591	77	142	TT1511	51	137
W70	50	134	W996	50	134	WW960	44	127	T1621	47	132	TT1512	51	137
W71	50	134	W997	50	134	WW961	44	127	T1631	48	132	TT1513	51	137
W72	49	134	W1208	51	137	WW962	44	127	T2011	47	129	TT1611	50	134
W73	49	134	W1210	51	137	WW963	44	127	T2031	48	129	TT9061	51	137
W91	50	134	W1507	51	137	WW964	44	127	T3551	62	138	TT9071	51	137
W92	47	132	WS82	47	129	WW965	44	127	T4251	61	139	TT9091	51	137
W97	44	127	WS92	47	132	WW1508	51	137	T9121	47	129	TT9351	50	134
W98	50	134	WS101	47	129	WW1509	51	137	T9131	47	129	TT9441	50	134
W99	50	134	WS102	47	129	WW1510	51	137	T9161	47	129			
W101	47	129	WS104	69	141	WW1511	51	137	T9211	47	129			
W112	44	127	WS131	47	129	WW1513	51	137	T9321	49	134			
W124	44	127	WS132	47	132	BIG BANG	MOTOR PUMP	143	T9731	49	134			
W130	44	127	WS133	47	129	BLUE TIME	MOTOR PUMP	143	T9791	49	134			
W131	47	129	WS135	48	129	BOXJET	MOTOR PUMP	143	T9951	50	134			
W132	47	132	WS137	50	134	CLEANMATIC	MOTOR PUMP	143	T9961	50	134			
W140	44	127	WS149	50	134	FLASH	MOTOR PUMP	143	T9971	50	134			
W150	44	127	WS151	47	129	FORMULA 99	MOTOR PUMP	143	TS821	47	129			
W151	47	129	WS152	47	129	GONG	MOTOR PUMP	143	TS921	47	132			
W154	44	132	WS153	69	141	GREEN JET	MOTOR PUMP	143	TS1011	47	129			
W155	76	142	WS162	47	132	TURBO	MOTOR PUMP	143	TS1021	47	129			
W159	77	142	WS171	47	129				TS1041	69	141			
W162	47	132	WS201	47	129				TS1311	47	129			
W163	48	132	WS202	47	129				TS1321	47	132			

<p>ZX.0063 Kit Dolly 123 valves + O-Rings</p>  <p>gr. 85 oz. 3.0</p> <p>quantity 2x6</p>	<p>ZX.0083 Set Dolly 123-30 valves + O-Rings</p>  <p>gr. 390 oz. 13.8</p> <p>quantity 2x30</p>	<p>ZX.0317 Set Dolly 123-500 valves + O-Rings</p>  <p>gr. 6700 oz. 236.6</p> <p>quantity 2x500</p>	<p>ZX.0579 Set Dolly 1/123-50 OR O-Ring for Kit Dolly 1 and 123</p>  <p>gr. 22 oz. 0.8</p> <p>quantity 1x50</p>	<p>ZX.0166 Kit Dolly 124 brass cap + O-Rings</p>  <p>gr. 670 oz. 23.7</p> <p>quantity 2x6</p>	<p>ZX.0734 Brass cap + O-Rings, with hole threaded G1/4" F</p>  <p>gr. 95 oz. 3.4</p> <p>quantity 2x1</p>
<p>ZX.0155 Kit Dolly 88 seal packing ø15</p>  <p>gr. 20 oz. 0.8</p> <p>quantity 3x3</p>	<p>ZX.0047 Set Dolly 97-60HP h.p. seals ø15x25</p>  <p>gr. 100 oz. 3.6</p> <p>quantity 1x60</p>	<p>ZX.0402 Set Dolly 97-500HP h.p. seals ø15x25</p>  <p>gr. 3300 oz. 116.5</p> <p>quantity 1x500</p>	<p>ZX.0530 Set Dolly 88-60LP l.p. seals ø15x25</p>  <p>gr. 100 oz. 3.6</p> <p>quantity 1x60</p>		
<p>ZX.0093 Kit Dolly 127 seal packing ø18</p>  <p>gr. 30 oz. 1.1</p> <p>quantity 3x3</p>	<p>ZX.0045 Set Dolly 127-60HP h.p. seals ø18x30</p>  <p>gr. 100 oz. 3.6</p> <p>quantity 1x60</p>	<p>ZX.0395 Set Dolly 127-500HP h.p. seals ø18x30</p>  <p>gr. 3300 oz. 116.5</p> <p>quantity 1x500</p>	<p>ZX.0397 Set Dolly 127-500LP l.p. seals ø18x30</p>  <p>gr. 3300 oz. 116.5</p> <p>quantity 1x500</p>		
<p>ZX.0158 Kit Dolly 90 head rings ø15</p>  <p>gr. 15 oz. 0.6</p> <p>quantity 1x6</p>	<p>ZX.0524 Set Dolly 90-60 head rings ø15</p>  <p>gr. 45 oz. 1.6</p> <p>quantity 1x60</p>	<p>ZX.0399 Set Dolly 90-500 head rings ø15</p>  <p>gr. 1000 oz. 35.3</p> <p>quantity 1x500</p>	<p>ZX.0164 Kit Dolly 129 head rings ø18</p>  <p>gr. 15 oz. 0.6</p> <p>quantity 1x6</p>	<p>ZX.0525 Set Dolly 129-60 head rings ø18</p>  <p>gr. 65 oz. 2.3</p> <p>quantity 1x60</p>	
<p>ZX.0157 Kit Dolly 89 intermediate ring ø15</p>  <p>gr. 90 oz. 3.2</p> <p>quantity 1x3</p>	<p>ZX.0163 Kit Dolly 128 intermediate ring ø18</p>  <p>gr. 1100 oz. 38.9</p> <p>quantity 1x3</p>	<p>ZX.0159 Kit Dolly 125 packing retainers + O-Rings ø15</p>  <p>gr. 210 oz. 7.5</p> <p>quantity 2x3</p>	<p>ZX.0156 Kit Dolly 126 packing retainers + O-Rings ø18</p>  <p>gr. 130 oz. 4.6</p> <p>quantity 2x3</p>	<p>ZX.0576 Set Dolly 22-50 OR O-Ring for Kit Dolly 125 and 126</p>  <p>gr. 17 oz. 0.6</p> <p>quantity 1x50</p>	

ZX.0162 Kit Dolly 130 complete seal packing ø15 		ZX.0165 Kit Dolly 131 complete seal packing ø18 		ZX.0067 Kit Dolly 23 plunger oil seals ø20x30x5 		ZX.0398 Set Dolly 23-500 plunger oil seals ø20x30x5 	
gr. 110 oz. 3.9	quantity 7x1	gr. 90 oz. 3.2	quantity 7x1	gr. 20 oz. 0.8	quantity 1x3	gr. 700 oz. 24.8	quantity 1x500

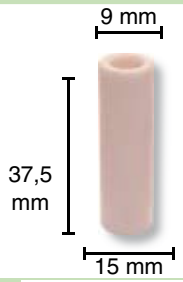
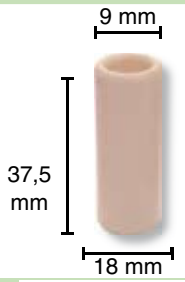
CR.A1258 Dolly i3 ceramic plunger ø15x37,5 		CR.A1487 Dolly i4 ceramic plunger ø18x37,5 	
gr. 16 oz. 0.6	quantity 1	gr. 30 oz. 1.1	quantity 1



















Club dei Riparatori®

THE WINNING SOLUTION TO MANUFACTURE AND REPAIR ALL KINDS OF PRESSURE WASHERS

www.sparesclub.com





For pumps fitting Interpump	Valves + caps		Seal packing + head rings				Intermediate ring + packing retainers				Complete seal packing		Oil seals	Plungers	
	Kit Dolly 123 ZX.0063	Kit Dolly 124 ZX.0166	Kit Dolly 88 ZX.0155	Kit Dolly 127 ZX.0093	Kit Dolly 90 ZX.0158	Kit Dolly 129 ZX.0164	Kit Dolly 89 ZX.0157	Kit Dolly 128 ZX.0163	Kit Dolly 125 ZX.0159	Kit Dolly 126 ZX.0156	Kit Dolly 130 ZX.0162	Kit Dolly 131 ZX.0165	Kit Dolly 23 ZX.0067	Dolly i3 CR.A1258	Dolly i4 CR.A1487
W97	•	•		•		•		•		•		•		•	
W112	•	•		•		•		•		•		•		•	
W124	•	•		•		•		•		•		•		•	
W130	•	•	•		•		•		•		•		•		
W140	•	•		•		•		•		•		•		•	
W150	•	•	•		•		•		•		•		•		
W154	•	•		•		•		•		•		•		•	
W170	•	•	•		•		•		•		•		•		
W950	•	•	•		•		•		•		•		•		
W951	•	•	•		•		•		•		•		•		
W952	•	•	•		•		•		•		•		•		
W953	•	•	•		•		•		•		•		•		
W954	•	•		•		•		•		•		•		•	
W955	•	•		•		•		•		•		•		•	
W956	•	•		•		•		•		•		•		•	
W957	•	•		•		•		•		•		•		•	
W958	•	•		•		•		•		•		•		•	
W959	•	•		•		•		•		•		•		•	
WW116	•	•	•		•		•		•		•		•		
WW136	•	•	•		•		•		•		•		•		
WW156	•	•	•		•		•		•		•		•		
WW176	•	•	•		•		•		•		•		•		
WW186	•	•	•		•		•		•		•		•		
WW189	•	•	•		•		•		•		•		•		
WW206	•	•	•		•		•		•		•		•		
WW209	•	•	•		•		•		•		•		•		
WW960	•	•	•		•		•		•		•		•		
WW961	•	•	•		•		•		•		•		•		
WW962	•	•	•		•		•		•		•		•		
WW963	•	•											•		
WW964	•	•											•		
WW965	•	•											•		



<p>ZX.0040 Kit Dolly 1 valves + O-Rings</p>  <p>gr. 85 oz. 3.0</p> <p>quantity 2x6</p>	<p>ZX.0048 Set Dolly 1-30 valves + O-Rings</p>  <p>gr. 390 oz. 13.8</p> <p>quantity 2x30</p>	<p>ZX.0287 Set Dolly 1-500 valves + O-Rings</p>  <p>gr. 6700 oz. 236.6</p> <p>quantity 2x500</p>	<p>ZX.0579 Set Dolly 1/123-50 OR O-Rings for Kit Dolly 1 and 123</p>  <p>gr. 22 oz. 0.8</p> <p>quantity 1x50</p>	
<p>ZX.0151 Kit Dolly 4 brass caps + O-Rings</p>  <p>gr. 550 oz. 19.5</p> <p>quantity 2x6</p>	<p>ZX.0732 Brass cap + O-Ring, threaded G1/4" F</p>  <p>gr. 75 oz. 2.7</p> <p>quantity 2x1</p>	<p>ZX.0169 Kit Dolly 5 nickeled caps + O-Rings</p>  <p>gr. 550 oz. 19.5</p> <p>quantity 2x6</p>	<p>ZX.0733 Nickel cap + O-Ring, threaded G1/4" F</p>  <p>gr. 75 oz. 2.7</p> <p>quantity 2x1</p>	<p>ZX.0580 Set Dolly 4/5-50 OR O-Rings for Kit Dolly 4 and 5</p>  <p>gr. 22 oz. 0.8</p> <p>quantity 1x50</p>
<p>CDR.0639 BRASS head for pumps fitting Interpump "47" series</p>  <p>gr. 3450 oz. 121.8</p> <p>quantity 1</p>		<p>CDR.0640 NICKELED head for pumps fitting Interpump "47" series</p>  <p>gr. 3450 oz. 121.8</p> <p>quantity 1</p>		
<p>ZX.0087 Kit Dolly 69 seal packing ø20</p>  <p>gr. 40 oz. 1.5</p> <p>quantity 3x3</p>	<p>ZX.0086 Kit Dolly 8 high and low pressure seals ø20x35</p>  <p>gr. 40 oz. 1.5</p> <p>quantity 2x3</p>	<p>ZX.0038 Kit Dolly 8 OLD h.p. seals ø20x35</p>  <p>gr. 30 oz. 1.1</p> <p>quantity 1x6</p>		
<p>ZX.0041 Set Dolly 8 OLD-60 h.p. seals ø20x35</p>  <p>gr. 255 oz. 9.0</p> <p>quantity 1x60</p>	<p>ZX.0288 Set Dolly 8 OLD-500 h.p. seals ø20x35</p>  <p>gr. 3300 oz. 116.5</p> <p>quantity 1x500</p>	<p>ZX.0533 Set Dolly 8-60LP l.p. seals ø20x35</p>  <p>gr. 255 oz. 9.0</p> <p>quantity 1x60</p>	<p>ZX.0308 Set Dolly 8-500LP l.p. seals ø20x35</p>  <p>gr. 3300 oz. 116.5</p> <p>quantity 1x500</p>	

<p>ZX.0727 Set Dolly 69-60RS restop rings ø20</p>  <p>gr. 105 oz. 3.7</p> <p>quantity 1x60</p>	<p>ZX.0320 Set Dolly 69-500RS restop rings ø20</p>  <p>gr. 850 oz. 30.0</p> <p>quantity 1x500</p>	<p>ZX.0136 Kit Dolly 7 head rings ø20</p>  <p>gr. 20 oz. 0.8</p> <p>quantity 1x6</p>	<p>ZX.0523 Set Dolly 7-60 head rings ø20</p>  <p>gr. 125 oz. 4.5</p> <p>quantity 1x60</p>	<p>ZX.0325 Set Dolly 7-500 head rings ø20</p>  <p>gr. 1000 oz. 35.3</p> <p>quantity 1x500</p>	
<p>ZX.0141 Kit Dolly 71 intermediate ring + restop ø20</p>  <p>gr. 145 oz. 5.2</p> <p>quantity 2x3</p>	<p>ZX.0289 Kit Dolly 9 intermediate ring + long life ø20</p>  <p>gr. 160 oz. 5.7</p> <p>quantity 2x3</p>	<p>ZX.0020 Set Dolly LONG LIFE-60</p>  <p>gr. 25 oz. 0.9</p> <p>quantity 1x60</p>	<p>ZX.0390 Kit Dolly 10 FLEARING packing retainers + O-Rings ø20</p>  <p>gr. 215 oz. 7.6</p> <p>quantity 2x3</p>	<p>ZX.0137 Kit Dolly 10 OLD packing retainers + O-Rings ø20</p>  <p>gr. 215 oz. 7.6</p> <p>quantity 2x3</p>	
<p>ZX.0573 Set Dolly 10-50 OR O-Rings for Kit Dolly 10, 10 OLD and 14</p>  <p>gr. 18 oz. 0.7</p> <p>quantity 1x50</p>	<p>ZX.0391 Kit Dolly 28 NEW complete seal packing (with FLEARING RETAINER) ø20x35</p>  <p>gr. 130 oz. 4.6</p> <p>quantity 7X1</p>	<p>ZX.0090 Kit Dolly 28 complete seal packing ø20x35</p>  <p>gr. 130 oz. 4.6</p> <p>quantity 7X1</p>	<p>ZX.0290 Kit Dolly 28 OLD complete seal packing (with LONG LIFE) ø20x35</p>  <p>gr. 135 oz. 4.8</p> <p>quantity 8X1</p>		
<p>ZX.0110 Kit Dolly 2 plunger oil seals ø22x32x5,5</p>  <p>gr. 25 oz. 0.9</p> <p>quantity 1x3</p>	<p>ZX.0068 Kit Dolly 24 plunger oil seals ø22x35x8</p>  <p>gr. 30 oz. 1.1</p> <p>quantity 1x3</p>	<p>ZX.0074 Kit Dolly 3 shaft oil seals ø30x55x7</p>  <p>gr. 45 oz. 1.6</p> <p>quantity 1x2</p>	<p>ZX.0537 Kit Dolly 101 high temperature, valves + O-Rings</p>  <p>gr. 85 oz. 3.0</p> <p>quantity 2x6</p>		
<p>ZX.0135 Kit Dolly 6 plunger bolts</p>  <p>gr. 90 oz. 3.2</p> <p>quantity 5x3</p>	<p>ZX.0345 Kit Dolly 6IP O-Rings and washers for Kit Dolly 6 plunger bolts</p>  <p>gr. 18 oz. 0.7</p> <p>quantity 4x3</p>	<p>CR.A1979 Dolly i2 ceramic plunger ø20x50</p>  <p>14 mm 50 mm 20 mm</p> <p>gr. 30 oz. 1.1</p> <p>quantity 1</p>	<p>ZX.0170 Kit Dolly 100HP high temperature, seal packing + O-Rings ø20</p>  <p>gr. 40 oz. 1.5</p> <p>quantity 6x3</p>		
				<p>ZX.0536 Kit Dolly 100 high temperature, complete seal packing + valves ø20</p>  <p>gr. 430 oz. 15.2</p> <p>quantity 8x3</p> <p>High temperature kit for pump fitting Interpump / Generalpump 47 and 48 series ø20</p>	



For pumps fitting:	Valves + caps + heads					Seal packing + head rings				Intermediate ring + packing retainers				Complete seal packing		Oil seals			Plunger + bolts		H.t. kit		
	Kit Dolly 1 ZX.0040	Kit Dolly 4 ZX.0151	Kit Dolly 5 ZX.0169	BRASS head CDR.0639	NICKELED head CDR.0639	Kit Dolly 69 ZX.0087	Kit Dolly 8 ZX.0086	Kit Dolly 8 OLD ZX.0038	Kit Dolly 7 ZX.0136	Kit Dolly 71 ZX.0141	Kit Dolly 9 ZX.0289	Kit Dolly 10 ZX.0390	Kit Dolly 10 OLD ZX.0137	Kit Dolly 28 NEW ZX.0391	Kit Dolly 28 ZX.0090	Kit Dolly 28 OLD ZX.0290	Kit Dolly 2 ZX.0110	Kit Dolly 24 ZX.0068	Kit Dolly 3 ZX.0074	Kit Dolly 6 ZX.0135	Dolly i2 CR.A1979	Kit Dolly 101 ZX.0537	Kit Dolly 100 ZX.0536
Interpump:																							
W101	•	•		•		•	•	•	•	•	•	•	•	•	•	•			•	•	•	•	•
W131	•	•		•		•	•	•	•	•	•	•	•	•	•	•			•	•	•	•	•
W151	•	•		•		•	•	•	•	•	•	•	•	•	•	•			•	•	•	•	•
W201	•		•		•	•	•	•	•	•	•	•	•	•	•	•			•	•	•	•	•
W203	•	•				•	•	•	•	•	•	•	•	•	•		•		•	•	•	•	•
W912	•	•		•		•	•	•	•	•	•	•	•	•	•	•			•	•	•	•	•
W913	•	•		•		•	•	•	•	•	•	•	•	•	•	•			•	•	•	•	•
W916	•		•		•	•	•	•	•	•	•	•	•	•	•	•			•	•	•	•	•
W921	•		•		•	•	•	•	•	•	•	•	•	•	•	•			•	•	•	•	•
WS82	•	•		•		•	•	•	•	•	•	•	•	•	•	•			•	•	•	•	•
WS101	•	•		•		•	•	•	•	•	•	•	•	•	•	•			•	•	•	•	•
WS102	•	•		•		•	•	•	•	•	•	•	•	•	•	•			•	•	•	•	•
WS131	•	•		•		•	•	•	•	•	•	•	•	•	•	•			•	•	•	•	•
WS133	•	•		•		•	•	•	•	•	•	•	•	•	•	•			•	•	•	•	•
WS135	•	•				•	•	•	•	•	•	•	•	•	•		•		•	•	•	•	•
WS151	•	•		•		•	•	•	•	•	•	•	•	•	•	•			•	•	•	•	•
WS152	•		•		•	•	•	•	•	•	•	•	•	•	•	•			•	•	•	•	•
WS171	•	•		•		•	•	•	•	•	•	•	•	•	•	•			•	•	•	•	•
WS201	•		•		•	•	•	•	•	•	•	•	•	•	•	•			•	•	•	•	•
WS202	•		•		•	•	•	•	•	•	•	•	•	•	•	•			•	•	•	•	•
Generalpump:																							
T1011	•	•		•		•	•	•	•	•	•	•	•	•	•	•			•	•	•	•	•
T1311	•	•		•		•	•	•	•	•	•	•	•	•	•	•			•	•	•	•	•
T1511	•	•		•		•	•	•	•	•	•	•	•	•	•	•			•	•	•	•	•
T2011	•		•		•	•	•	•	•	•	•	•	•	•	•	•			•	•	•	•	•
T2031	•	•				•	•	•	•	•	•	•	•	•	•		•		•	•	•	•	•
T9121	•	•		•		•	•	•	•	•	•	•	•	•	•	•			•	•	•	•	•
T9131	•	•		•		•	•	•	•	•	•	•	•	•	•	•			•	•	•	•	•
T9161	•		•		•	•	•	•	•	•	•	•	•	•	•	•			•	•	•	•	•
T9211	•		•		•	•	•	•	•	•	•	•	•	•	•	•			•	•	•	•	•
TS821	•	•		•		•	•	•	•	•	•	•	•	•	•	•			•	•	•	•	•
TS1011	•	•		•		•	•	•	•	•	•	•	•	•	•	•			•	•	•	•	•
TS1021	•	•		•		•	•	•	•	•	•	•	•	•	•	•			•	•	•	•	•
TS1311	•	•		•		•	•	•	•	•	•	•	•	•	•	•			•	•	•	•	•
TS1331	•	•		•		•	•	•	•	•	•	•	•	•	•	•			•	•	•	•	•
TS1351	•	•				•	•	•	•	•	•	•	•	•	•		•		•	•	•	•	•
TS1511	•	•		•		•	•	•	•	•	•	•	•	•	•	•			•	•	•	•	•
TS1521	•		•		•	•	•	•	•	•	•	•	•	•	•	•			•	•	•	•	•
TS1711	•	•		•		•	•	•	•	•	•	•	•	•	•	•			•	•	•	•	•
TS2011	•		•		•	•	•	•	•	•	•	•	•	•	•	•			•	•	•	•	•
TS2021	•		•		•	•	•	•	•	•	•	•	•	•	•	•			•	•	•	•	•

Dolly kits stressed with the red spot are mounted on the 1st version pumps fitting **Interpump** and **Generalpump**; they are equipped with the LONG LIFE seal.

<p>ZX.0040 Kit Dolly 1 valves + O-Rings</p>  <p>gr. 85 oz. 3.0</p> <p>quantity 2x6</p>	<p>ZX.0048 Set Dolly 1-30 valves + O-Rings</p>  <p>gr. 390 oz. 13.8</p> <p>quantity 2x30</p>	<p>ZX.0287 Set Dolly 1-500 valves + O-Rings</p>  <p>gr. 6700 oz. 236.6</p> <p>quantity 2x500</p>	<p>ZX.0579 Set Dolly 1/123-50 OR O-Rings for Kit Dolly 1 and 123</p>  <p>gr. 22 oz. 0.8</p> <p>quantity 1x50</p>	
<p>ZX.0151 Kit Dolly 4 brass caps + O-Rings</p>  <p>gr. 550 oz. 19.5</p> <p>quantity 2x6</p>	<p>ZX.0732 Brass cap + O-Ring, threaded G1/4" F</p>  <p>gr. 75 oz. 2.7</p> <p>quantity 2x1</p>	<p>ZX.0169 Kit Dolly 5 nickeled caps + O-Rings</p>  <p>gr. 550 oz. 19.5</p> <p>quantity 2x6</p>	<p>ZX.0733 Nickel cap + O-Ring, threaded G1/4" F</p>  <p>gr. 75 oz. 2.7</p> <p>quantity 2x1</p>	<p>ZX.0580 Set Dolly 4/5-50 OR O-Rings for Kit Dolly 4 and 5</p>  <p>gr. 22 oz. 0.8</p> <p>quantity 1x50</p>
<p>CDR.0639 BRASS head for pumps fitting Interpump "47" series</p>  <p>gr. 3450 oz. 121.8</p> <p>quantity 1</p>		<p>CDR.0640 NICKELED head for pumps fitting Interpump "47" series</p>  <p>gr. 3450 oz. 121.8</p> <p>quantity 1</p>		
<p>ZX.0220 Kit Dolly 148 seal packing ø22</p>  <p>gr. 40 oz. 1.5</p> <p>quantity 3x3</p>	<p>ZX.0057 Kit Dolly 12 high and low pressure seals ø22x35</p>  <p>gr. 35 oz. 1.3</p> <p>quantity 2x3</p>	<p>ZX.0042 Kit Dolly 12 OLD h.p. seals ø22X35</p>  <p>gr. 30 oz. 1.1</p> <p>quantity 1x6</p>	<p>ZX.0044 Set Dolly 12 OLD-60 h.p. seals ø22X35</p>  <p>gr. 230 oz. 8.2</p> <p>quantity 1x60</p>	
<p>ZX.0534 Set Dolly 12-60LP l.p. seals ø22x35</p>  <p>gr. 330 oz. 11.7</p> <p>quantity 1x60</p>	<p>ZX.0848 Set Dolly 148-60RS restop rings ø22</p>  <p>gr. 100 oz. 3.6</p> <p>quantity 1x60</p>	<p>ZX.0217 Kit Dolly 11 head rings ø22</p>  <p>gr. 20 oz. 0.8</p> <p>quantity 1x6</p>	<p>ZX.0526 Set Dolly 11-60 head rings ø22</p>  <p>gr. 125 oz. 4.5</p> <p>quantity 1x60</p>	

ZX.0221 Kit Dolly 149 intermediate ring + restop ø22 		ZX.0218 Kit Dolly 14 packing retainers + O-Rings ø22 		ZX.0573 Set Dolly 10-50 OR O-Rings for Kit Dolly 10, 10 OLD and 14 		ZX.0219 Kit Dolly 29 complete seal packing ø22 	
gr. 130 oz. 4.6	quantity 2x3	gr. 185 oz. 6.6	quantity 2x3	gr. 18 oz. 0.7	quantity 1x50	gr. 115 oz. 4.1	quantity 7x1

ZX.0110 Kit Dolly 2 plunger oil seals ø22x32x5,5 		ZX.0068 Kit Dolly 24 plunger oil seals ø22x35x8 		ZX.0074 Kit Dolly 3 shaft oil seals ø30x55x7 	
gr. 25 oz. 0.9	quantity 1x3	gr. 30 oz. 1.1	quantity 1x3	gr. 45 oz. 1.6	quantity 1x2



ZX.0135 Kit Dolly 6 plunger bolts 		ZX.0345 Kit Dolly 6 OR O-Rings and washers for Kit Dolly 6 plunger bolts 		CR.A1234 Dolly i5 ceramic plunger ø22x50 	
gr. 90 oz. 3.2	quantity 5x3	gr. 18 oz. 0.7	quantity 4x3	gr. 30 oz. 1.1	quantity 1











Idrobase
since 1986

*We spent
the first
20 years
of our lives
to build our boat.
Now we are ready
to plough
through markets
of the world.*

Idrobase Team

For pumps fitting:	Valves + caps + heads				Seal packing + head rings				Intermediate ring + packing retainers		Complete seal packing	Oil seals			Plunger + bolts		
	Kit Dolly 1 ZX.0040	Kit Dolly 4 ZX.0151	Kit Dolly 5 ZX.0169	BRASS head CDR.0639	NICKELLED head CDR.0640	Kit Dolly 148 ZX.0220	Kit Dolly 12 ZX.0057	Kit Dolly 12 OLD ZX.0042	Kit Dolly 11 ZX.0217	Kit Dolly 149 ZX.0221	Kit Dolly 14 ZX.0218	Kit Dolly 29 ZX.0219	Kit Dolly 2 ZX.0110	Kit Dolly 24 ZX.0068	Kit Dolly 3 ZX.0074	Kit Dolly 6 ZX.0135	Dolly i5 CR.A1234
Interpump:																	
W92	•	•		•		•	•	•	•	•	•	•	•	•	•	•	•
W132	•	•		•		•	•	•	•	•	•	•	•	•	•	•	•
W162	•		•		•	•	•	•	•	•	•	•	•	•	•	•	•
W163	•	•				•	•	•	•	•	•	•		•		•	•
WS92	•	•		•		•	•	•	•	•	•	•	•	•	•	•	•
WS132	•	•		•		•	•	•	•	•	•	•	•	•	•	•	•
WS162	•		•		•	•	•	•	•	•	•	•	•	•	•	•	•
Generalpump:																	
T921	•	•				•	•	•	•	•	•	•	•		•	•	•
T1321	•	•				•	•	•	•	•	•	•	•		•	•	•
T1621	•		•			•	•	•	•	•	•	•	•		•	•	•
T1631	•	•				•	•	•	•	•	•	•		•		•	•
TS921	•	•				•	•	•	•	•	•	•	•		•	•	•
TS1321	•	•				•	•	•	•	•	•	•	•		•	•	•
TS1621	•		•			•	•	•	•	•	•	•	•		•	•	•

<p>ZX.0040 Kit Dolly 1 valves + O-Ring</p>  <p>gr. 85 oz. 3.0</p> <p>quantity 2x6</p>	<p>ZX.0048 Set Dolly 1-30 valves + O-Ring</p>  <p>gr. 390 oz. 13.8</p> <p>quantity 2x30</p> <p>DOLLY Spare Parts 30</p>	<p>ZX.0287 Set Dolly 1-500 valves + O-Ring</p>  <p>gr. 6700 oz. 236.6</p> <p>quantity 2x500</p> <p>DOLLY Spare Parts 500</p>	<p>ZX.0579 Set Dolly 1/123-50 OR O-Rings for Kit Dolly 1 and 123</p>  <p>gr. 22 oz. 0.8</p> <p>quantity 1x50</p> <p>DOLLY Spare Parts 50</p>		
<p>ZX.0151 Kit Dolly 4 brass caps + O-Rings</p>  <p>gr. 550 oz. 19.5</p> <p>quantity 2x6</p>	<p>ZX.0732 Brass cap + O-Ring, threaded G1/4" F</p>  <p>gr. 75 oz. 2.7</p> <p>quantity 2x1</p>	<p>ZX.0580 Set Dolly 4/5-50 OR O-Ring for Kit Dolly 4 and 5</p>  <p>gr. 22 oz. 0.8</p> <p>quantity 1x50</p> <p>DOLLY Spare Parts 50</p>			
<p>ZX.0155 Kit Dolly 88 seal packing ø15</p>  <p>gr. 20 oz. 0.8</p> <p>quantity 3x3</p>	<p>ZX.0047 Set Dolly 97-60HP h.p. seals ø15x25</p>  <p>gr. 100 oz. 3.6</p> <p>quantity 1x60</p> <p>DOLLY Spare Parts 60</p>	<p>ZX.0402 Set Dolly 97-500HP h.p. seals ø15x25</p>  <p>gr. 3300 oz. 116.5</p> <p>quantity 1x500</p> <p>DOLLY Spare Parts 500</p>	<p>ZX.0530 Set Dolly 88-60LP l.p. seals ø15x25</p>  <p>gr. 130 oz. 116.5</p> <p>quantity 1x60</p> <p>DOLLY Spare Parts 60</p>		
<p>ZX.0088 Kit Dolly 19 high and low pressure seals ø20x30</p>  <p>gr. 20 oz. 0.8</p> <p>quantity 2x3</p>	<p>ZX.0085 Kit Dolly 19 OLD h.p. seals ø20x30</p>  <p>gr. 20 oz. 0.8</p> <p>quantity 1x6</p>	<p>ZX.0046 Set Dolly 19 OLD-60 h.p. seals ø20x30</p>  <p>gr. 120 oz. 4.3</p> <p>quantity 1x60</p> <p>DOLLY Spare Parts 60</p>	<p>ZX.0392 Set Dolly 19 OLD-500 h.p. seals ø20x30</p>  <p>gr. 3300 oz. 116.5</p> <p>quantity 1x500</p> <p>DOLLY Spare Parts 500</p>	<p>ZX.0393 Set Dolly 19-500LP l.p. seals ø20x30</p>  <p>gr. 3300 oz. 116.5</p> <p>quantity 1x500</p> <p>DOLLY Spare Parts 500</p>	
<p>ZX.0158 Kit Dolly 90 head rings ø15</p>  <p>gr. 15 oz. 0.6</p> <p>quantity 1x6</p>	<p>ZX.0524 Set Dolly 90-60 head rings ø15</p>  <p>gr. 45 oz. 1.6</p> <p>quantity 1x60</p> <p>DOLLY Spare Parts 60</p>	<p>ZX.0399 Set Dolly 90-500 head rings ø15</p>  <p>gr. 1000 oz. 35.3</p> <p>quantity 1x500</p> <p>DOLLY Spare Parts 500</p>	<p>ZX.0089 Kit Dolly 21 head rings ø20</p>  <p>gr. 15 oz. 0.6</p> <p>quantity 1x6</p>	<p>ZX.0522 Set Dolly 21-60 head rings ø20</p>  <p>gr. 85 oz. 0.6</p> <p>quantity 1x60</p> <p>DOLLY Spare Parts 60</p>	<p>ZX.0394 Set Dolly 21-500 head rings ø20</p>  <p>gr. 1000 oz. 35.3</p> <p>quantity 1x500</p> <p>DOLLY Spare Parts 500</p>

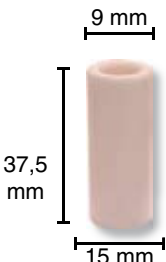
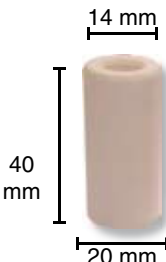

<p>ZX.0157 Kit Dolly 89 intermediate ring ø15</p>  <p>gr. 90 oz. 3.2</p> <p>quantity 1x3</p>	<p>ZX.0138 Kit Dolly 20 intermediate ring ø20</p>  <p>gr. 110 oz. 3.9</p> <p>quantity 1x3</p>	<p>ZX.0603 Kit Dolly 91 packing retainers + O-Rings ø15</p>  <p>gr. 210 oz. 7.5</p> <p>quantity 2x3</p>	<p>ZX.0139 Kit Dolly 22 packing retainers + O-Rings ø20</p>  <p>gr. 105 oz. 3.8</p> <p>quantity 2x3</p>	<p>ZX.0576 Set Dolly 22-50 OR O-Rings for Kit Dolly 22 and 91</p>  <p>gr. 17 oz. 0.6</p> <p>quantity 1x50</p>
<p>ZX.0604 Kit Dolly 92 complete seal packing ø15</p>  <p>gr. 100 oz. 3.6</p> <p>quantity 7x1</p>	<p>ZX.0140 Kit Dolly 27 complete seal packing ø20x30</p>  <p>gr. 80 oz. 2.9</p> <p>quantity 6x1</p>			
<p>ZX.0067 Kit Dolly 23 plunger oil seals ø20x30x5</p>  <p>gr. 20 oz. 0.8</p> <p>quantity 1x3</p>	<p>ZX.0398 Set Dolly 23-500 plunger oil seals ø20x30x5</p>  <p>gr. 700 oz. 24.8</p> <p>quantity 1x500</p>			
<p>ZX.0135 Kit Dolly 6 plunger bolts</p>  <p>gr. 90 oz. 3.2</p> <p>quantity 5x3</p>	<p>ZX.0345 Kit Dolly 6IP O-Rings and washers for Kit Dolly 6 plunger bolts</p>  <p>gr. 18 oz. 0.7</p> <p>quantity 4x3</p>			
<p>CR.A1258 Dolly i3 ceramic plunger ø15x37,5</p>  <p>gr. 16 oz. 0.6</p> <p>quantity 1</p>	<p>CR.A1980 Dolly i1 ceramic plunger ø20x40</p>  <p>gr. 25 oz. 0.9</p> <p>quantity 1</p>			

Idrobase... *The pocket multinational*



*5 companies,
each of them specialized
in a niche of the pressure
water market
and together they form the
most innovative solution
now present on the market.*

For pumps fitting:	Valves + caps		Seal packing + head rings				Intermediate ring + packing retainers				Complete seal packing		Oil seals	Plunger + bolts		
	Kit Dolly 1 ZX.0040	Kit Dolly 4 ZX.0151	Kit Dolly 88 ZX.0155	Kit Dolly 19 ZX.0088	Kit Dolly 19 OLD ZX.0085	Kit Dolly 90 ZX.0158	Kit Dolly 21 ZX.0089	Kit Dolly 89 ZX.0157	Kit Dolly 20 ZX.0138	Kit Dolly 91 ZX.0603	Kit Dolly 22 ZX.0139	Kit Dolly 92 ZX.0604	Kit Dolly 27 ZX.0140	Kit Dolly 23 ZX.0067	Kit Dolly 6 ZX.0135	Dolly 13 CR.A1258
Interpump:																
W52	•	•		•	•		•		•		•		•	•		•
W53	•	•		•	•		•		•		•		•	•		•
W70	•	•		•	•		•		•		•		•	•		•
W71	•	•		•	•		•		•		•		•	•		•
W72	•	•		•	•		•		•		•		•	•		•
W73	•	•		•	•		•		•		•		•	•		•
W91	•	•		•	•		•		•		•		•	•		•
W98	•	•		•	•		•		•		•		•	•		•
W99	•	•		•	•		•		•		•		•	•		•
W972	•	•		•	•		•		•		•		•	•		•
W973	•	•		•	•		•		•		•		•	•		•
W979	•	•		•	•		•		•		•		•	•		•
W995	•	•		•	•		•		•		•		•	•		•
W996	•	•		•	•		•		•		•		•	•		•
W997	•	•		•	•		•		•		•		•	•		•
WS137	•	•		•	•		•		•		•		•	•		•
WS149	•	•		•	•		•		•		•		•	•		•
WW141	•	•	•			•		•		•	•		•		•	
WW161	•	•	•			•		•		•	•		•		•	
WW935	•	•	•			•		•		•	•		•		•	
WW944	•	•	•			•		•		•	•		•		•	
Generalpump:																
T521	•	•		•	•		•		•		•		•	•		•
T531	•	•		•	•		•		•		•		•	•		•
T701	•	•		•	•		•		•		•		•	•		•
T711	•	•		•	•		•		•		•		•	•		•
T721	•	•		•	•		•		•		•		•	•		•
T731	•	•		•	•		•		•		•		•	•		•
T911	•	•		•	•		•		•		•		•	•		•
T981	•	•		•	•		•		•		•		•	•		•
T991	•	•		•	•		•		•		•		•	•		•
T9321	•	•		•	•		•		•		•		•	•		•
T9731	•	•		•	•		•		•		•		•	•		•
T9791	•	•		•	•		•		•		•		•	•		•
T9951	•	•		•	•		•		•		•		•	•		•
T9961	•	•		•	•		•		•		•		•	•		•
T9971	•	•		•	•		•		•		•		•	•		•
TS1371	•	•		•	•		•		•		•		•	•		•
TS1491	•	•		•	•		•		•		•		•	•		•
TT1411	•	•	•			•		•		•	•		•		•	
TT1611	•	•	•			•		•		•	•		•		•	
TT9351	•	•	•			•		•		•	•		•		•	
TT9441	•	•	•			•		•		•	•		•		•	

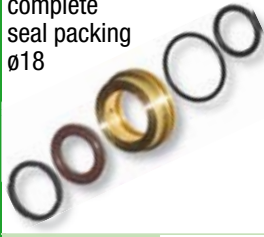
<p>ZX.0040 Kit Dolly 1 valves + O-Rings</p>  <p>gr. 85 oz. 3.0</p> <p>quantity 2x6</p>	<p>ZX.0048 Set Dolly 1-30 valves + O-Rings</p>  <p>gr. 390 oz. 13.8</p> <p>quantity 2x30</p>	<p>ZX.0287 Set Dolly 1-500 valves + O-Rings</p>  <p>gr. 6700 oz. 236.6</p> <p>quantity 2x500</p>	<p>ZX.0579 Set Dolly 1/123-50 OR O-Ring for Kit Dolly 1 and 123</p>  <p>gr. 22 oz. 0.8</p> <p>quantity 1x50</p>	
<p>ZX.0063 Kit Dolly 123 valves + O-Rings</p>  <p>gr. 85 oz. 3.0</p> <p>quantity 2x6</p>	<p>ZX.0083 Set Dolly 123-30 valves + O-Rings</p>  <p>gr. 390 oz. 13.8</p> <p>quantity 2x30</p>	<p>ZX.0317 Set Dolly 123-500 valves + O-Rings</p>  <p>gr. 6700 oz. 236.6</p> <p>quantity 2x500</p>		
<p>ZX.0535 Kit Dolly 97 seal packing ø15</p>  <p>gr. 15 oz. 0.6</p> <p>quantity 4x3</p>	<p>ZX.0047 Set Dolly 97-60HP h.p. seals ø15x25</p>  <p>gr. 100 oz. 3.6</p> <p>quantity 1x60</p>	<p>ZX.0402 Set Dolly 97-500HP h.p. seals ø15x25</p>  <p>gr. 3300 oz. 116.5</p> <p>quantity 1x500</p>	<p>ZX.0702 Kit Dolly 141 seal packing ø18</p>  <p>gr. 16 oz. 0.6</p> <p>quantity 4x3</p>	<p>ZX.0933 Set Dolly 141-60HP h.p. seals + head rings ø18x26</p>  <p>gr. 100 oz. 3.6</p> <p>quantity 2x60</p>
<p>ZX.0645 Kit Dolly 86 packing retainers + O-Rings ø15</p>  <p>gr. 90 oz. 3.2</p> <p>quantity 3x3</p>	<p>ZX.0707 Kit Dolly 139 packing retainers + O-Rings ø18</p>  <p>gr. 75 oz. 2.7</p> <p>quantity 3x3</p>	<p>ZX.0574 Set Dolly 86/139-50 OR O-Rings for Kit Dolly 86 and 139</p>  <p>gr. 22 oz. 0.8</p> <p>quantity 1x50</p>	<p>ZX.0644 Kit Dolly 96 complete seal packing ø15</p>  <p>gr. 40 oz. 1.5</p> <p>quantity 5x1</p>	<p>ZX.0701 Kit Dolly 140 complete seal packing ø18</p>  <p>gr. 35 oz. 1.3</p> <p>quantity 5x1</p>
<p>ZX.0065 Kit Dolly 83 plunger oil seals ø15x24x5</p>  <p>gr. 25 oz. 0.9</p> <p>quantity 1x3</p>	<p>FLM.0005 Dolly i6 ceramic plunger ø15x25</p>  <p>gr. 16 oz. 0.6</p> <p>quantity 1</p>	<p>CDR.0642 Dolly i7 ceramic plunger ø18x25</p>  <p>gr. 20 oz. 0.8</p> <p>quantity 1</p>		

For pumps fitting	Valves		Seal packing		Packing retainers		Complete seal packing		Oil seals	Plungers	
	Kit Dolly 1 ZX.0040	Kit Dolly 123 ZX.0063	Kit Dolly 97 ZX.0535	Kit Dolly 141 ZX.0702	Kit Dolly 86 ZX.0645	Kit Dolly 139 ZX.0707	Kit Dolly 96 ZX.0644	Kit Dolly 140 ZX.0701	Kit Dolly 83 ZX.0065	Dolly i6 FLM.0005	Dolly i7 CDR.0642
Interpump:											
W1208		•		•		•		•	•		•
W1210		•		•		•		•	•		•
W1507		•	•		•		•	•	•	•	
WW55	•		•		•		•	•	•	•	
WW56	•		•		•		•	•	•	•	
WW74	•		•		•		•	•	•	•	
WW75	•		•		•		•	•	•	•	
WW90	•		•		•		•	•	•	•	
WW93	•		•		•		•	•	•	•	
WW94	•		•		•		•	•	•	•	
WW95	•		•		•		•	•	•	•	
WW906		•	•		•		•	•	•	•	
WW907		•	•		•		•	•	•	•	
WW909		•	•		•		•	•	•	•	
WW1508		•	•		•		•	•	•	•	
WW1509		•	•		•		•	•	•	•	
WW1510		•	•		•		•	•	•	•	
WW1511		•	•		•		•	•	•	•	
WW1513		•	•		•		•	•	•	•	
Generalpump:											
T1209		•		•		•		•	•		•
T1212		•		•		•		•	•		•
T1508		•	•		•		•	•	•	•	
TT551	•		•		•		•	•	•	•	
TT561	•		•		•		•	•	•	•	
TT741	•		•		•		•	•	•	•	
TT751	•		•		•		•	•	•	•	
TT901	•		•		•		•	•	•	•	
TT931	•		•		•		•	•	•	•	
TT941	•		•		•		•	•	•	•	
TT951	•		•		•		•	•	•	•	
TT1508		•	•		•		•	•	•	•	
TT1510		•	•		•		•	•	•	•	
TT1511		•	•		•		•	•	•	•	
TT1512		•	•		•		•	•	•	•	
TT1513		•	•		•		•	•	•	•	
TT9061		•	•		•		•	•	•	•	
TT9071		•	•		•		•	•	•	•	
TT9091		•	•		•		•	•	•	•	

<p>ZX.0700 Kit Dolly 122 valves + O-Rings</p>  <p>gr. 300 oz. 10.6</p> <p>quantity 2x6</p>	<p>ZX.0694 Kit Dolly 77 seal packing ø20</p>  <p>gr. 55 oz. 2.0</p> <p>quantity 3x3</p>	<p>ZX.0038 Kit Dolly 8 OLD h.p. seals ø20x35</p>  <p>gr. 30 oz. 1.1</p> <p>quantity 1x6</p>	<p>ZX.0041 Set Dolly 8 OLD-60 h.p. seals ø20x35</p>  <p>gr. 255 oz. 9.0</p> <p>quantity 1x60</p>	<p>ZX.0288 Set Dolly 8 OLD-500 h.p. seals ø20x35</p>  <p>gr. 3300 oz. 116.5</p> <p>quantity 1x500</p>
---	--	--	--	--

<p>ZX.0086 Kit Dolly 8 high and low pressure seals ø20x35</p>  <p>gr. 40 oz. 1.5</p> <p>quantity 2x3</p>	<p>ZX.0533 Set Dolly 8-60LP l.p. seals ø20x35</p>  <p>gr. 3300 oz. 116.5</p> <p>quantity 1x60</p>	<p>ZX.0308 Set Dolly 8-500LP l.p. seals ø20x35</p>  <p>gr. 255 oz. 9.0</p> <p>quantity 1x500</p>	<p>ZX.0136 Kit Dolly 7 head rings ø20</p>  <p>gr. 20 oz. 0.8</p> <p>quantity 1x6</p>	<p>ZX.0523 Set Dolly 7-60 head rings ø20</p>  <p>gr. 125 oz. 4.5</p> <p>quantity 1x60</p>	<p>ZX.0325 Set Dolly 7-500 head rings ø20</p>  <p>gr. 3300 oz. 116.5</p> <p>quantity 1x500</p>
---	--	---	---	--	---

<p>ZX.0758 Kit Dolly 75 intermediate ring ø20</p>  <p>gr. 290 oz. 10.3</p> <p>quantity 1x3</p>	<p>ZX.0759 Kit Dolly 76 packing retainers + O-Rings ø20</p>  <p>gr. 1070 oz. 37.8</p> <p>quantity 2x3</p>	<p>ZX.0932 Set Dolly 76-50 OR O-Rings for kit Dolly 76</p>  <p>gr. 150 oz. 5.3</p> <p>quantity 1x50</p>	<p>ZX.0695 Kit Dolly 78 complete seal packing ø20</p>  <p>gr. 480 oz. 17.0</p> <p>quantity 7x1</p>
---	--	---	---

<p>ZX.0070 Kit Dolly 44 plunger oil seals ø35x52x7</p>  <p>gr. 65 oz. 2.3</p> <p>quantity 1x3</p>	<p>ZX.0410 Kit Dolly 32 shaft oil seals ø35x52x8</p>  <p>gr. 50 oz. 1.8</p> <p>quantity 1x2</p>	<p>ZX.0719 Dolly i10 plunger + seeger ø20x115</p>  <p>gr. 270 oz. 9.6</p> <p>quantity 2x1</p>
--	--	---

















DOLLY®
Spare Parts

Dolly Spare Parts® are
Club dei Riparatori®
by IDROBASE® products.



Dolly spare parts® is the complete range of accessories and components by Club dei Riparatori® by IDROBASE®, it enables you to service any kind of high pressure washer, even those of your competitors. Dolly spare parts® give you the opportunity to choose both the spare parts and supplier, according to your needs.

For pumps fitting	Valves		Seal packing + head rings		Intermediate ring + packing retainers		Complete seal packing		Oil seals		Plungers
	Kit Dolly 122 ZX.0700	Kit Dolly 77 ZX.0694	Kit Dolly 7 ZX.0136	Kit Dolly 75 ZX.0758	Kit Dolly 76 ZX.0759	Kit Dolly 78 ZX.0695	Kit Dolly 44 ZX.0070	Kit Dolly 32 ZX.0410	Dolly i10 ZX.0719		
Interpump:											
W355	•	•	•	•	•	•	•	•	•		
W425	•	•	•	•	•	•	•	•	•		
Generalpump:											
T3551	•	•	•	•	•	•	•	•	•		
T4251	•	•	•	•	•	•	•	•	•		

<p>ZX.0063 Kit Dolly 123 valves + O-Rings</p>  <p>gr. 85 quantity oz. 3.0 2x6</p>	<p>ZX.0083 Set Dolly 123-30 valves + O-Rings</p>  <p>gr. 390 quantity oz. 13.8 2x30</p>	<p>ZX.0317 Set Dolly 123-500 valves + O-Rings</p>  <p>gr. 6700 quantity oz. 236.6 2x500</p>	<p>ZX.0579 Set Dolly 1/123-50 OR O-Ring for Kit Dolly 1 and 123</p>  <p>gr. 22 quantity oz. 0.8 1x50</p>	<p>ZX.0166 Kit Dolly 124 brass cap + O-Rings</p>  <p>gr. 670 quantity oz. 23.7 2x6</p>	<p>ZX.0734 Brass cap + O-Rings, with threaded hole G1/4" F</p>  <p>gr. 95 quantity oz. 3.4 2x1</p>																																																																																																																																																																																																																																																								
<p>ZX.0703 Kit Dolly 160 seal packing ø15</p>  <p>gr. 20 quantity oz. 0.8 4x3</p>	<p>ZX.0928 Set Dolly 160-60HP h.p. seals + head rings ø15x24</p>  <p>gr. 170 quantity oz. 6.0 2x60</p>	<p>ZX.0929 Set Dolly 160-60LP l.p. seals ø15x22</p>  <p>gr. 80 quantity oz. 2.9 1x60</p>	<p>ZX.0704 Kit Dolly 161 seal packing ø18</p>  <p>gr. 25 quantity oz. 0.9 4x3</p>	<p>ZX.0930 Set Dolly 161-60HP h.p. seals + head rings ø18x28</p>  <p>gr. 260 quantity oz. 9.2 2x60</p>	<p>ZX.0931 Set Dolly 161-60LP l.p. seals ø18x25</p>  <p>gr. 80 quantity oz. 2.9 1x60</p>																																																																																																																																																																																																																																																								
<p>ZX.0710 Kit Dolly 164 intermediate ring ø15</p>  <p>gr. 80 quantity oz. 2.9 1x3</p>	<p>ZX.0711 Kit Dolly 165 intermediate ring ø18</p>  <p>gr. 70 quantity oz. 2.5 1x3</p>	<p>ZX.0708 Kit Dolly 162 packing retainers ø15</p>  <p>gr. 75 quantity oz. 2.7 1x3</p>	<p>ZX.0709 Kit Dolly 163 packing retainers ø18</p>  <p>gr. 60 quantity oz. 2.2 1x3</p>	<p>ZX.0705 Kit Dolly 166 complete seal packing ø15</p>  <p>gr. 60 quantity oz. 2.2 7x1</p>	<p>ZX.0706 Kit Dolly 167 complete seal packing ø18</p>  <p>gr. 55 quantity oz. 2.0 7x1</p>																																																																																																																																																																																																																																																								
<p>ZX.0413 Kit Dolly 159 plunger oil seals ø18x26x6</p>  <p>gr. 20 quantity oz. 0.8 1x3</p>	<div style="text-align: center;">  <p><i>Is the complete range of Club dei Riparatori® by IDROBASE® parts.</i></p> </div> <table border="1" data-bbox="566 1377 1492 2139"> <thead> <tr> <th rowspan="2">For pumps fitting Interpump and Generalpump</th> <th colspan="2">Valves + caps</th> <th colspan="2">Seal packing</th> <th colspan="4">Intermediate ring + packing retainers</th> <th colspan="2">Complete seal packing</th> <th>Oil seals</th> <th colspan="2">Plungers</th> </tr> <tr> <th>Kit Dolly 123 ZX.0063</th> <th>Kit Dolly 124 ZX.0166</th> <th>Kit Dolly 160 ZX.0703</th> <th>Kit Dolly 161 ZX.0704</th> <th>Kit Dolly 164 ZX.0710</th> <th>Kit Dolly 165 ZX.0711</th> <th>Kit Dolly 162 ZX.0708</th> <th>Kit Dolly 163 ZX.0709</th> <th>Kit Dolly 166 ZX.0705</th> <th>Kit Dolly 167 ZX.0706</th> <th>Kit Dolly 159 ZX.0413</th> <th>Dolly i3 CR.A1258</th> <th>Dolly i4 CR.A1487</th> </tr> </thead> <tbody> <tr><td>EH1413</td><td>•</td><td>•</td><td>•</td><td></td><td>•</td><td></td><td>•</td><td></td><td>•</td><td></td><td>•</td><td>•</td></tr> <tr><td>EH1416</td><td>•</td><td>•</td><td>•</td><td></td><td>•</td><td></td><td>•</td><td></td><td>•</td><td></td><td>•</td><td>•</td></tr> <tr><td>EH2009</td><td>•</td><td>•</td><td>•</td><td></td><td>•</td><td></td><td>•</td><td></td><td>•</td><td></td><td>•</td><td>•</td></tr> <tr><td>EH2011</td><td>•</td><td>•</td><td>•</td><td></td><td>•</td><td></td><td>•</td><td></td><td>•</td><td></td><td>•</td><td>•</td></tr> <tr><td>EL1411</td><td>•</td><td>•</td><td></td><td>•</td><td></td><td>•</td><td></td><td>•</td><td></td><td>•</td><td></td><td>•</td></tr> <tr><td>EL1413</td><td>•</td><td>•</td><td></td><td>•</td><td></td><td>•</td><td></td><td>•</td><td></td><td>•</td><td></td><td>•</td></tr> <tr><td>EL1714</td><td>•</td><td>•</td><td></td><td>•</td><td></td><td>•</td><td></td><td>•</td><td></td><td>•</td><td></td><td>•</td></tr> <tr><td>EL2007</td><td>•</td><td>•</td><td>•</td><td></td><td>•</td><td></td><td>•</td><td></td><td>•</td><td></td><td>•</td><td>•</td></tr> <tr><td>EL2009</td><td>•</td><td>•</td><td>•</td><td></td><td>•</td><td></td><td>•</td><td></td><td>•</td><td></td><td>•</td><td>•</td></tr> <tr><td>UH2008</td><td>•</td><td>•</td><td>•</td><td></td><td>•</td><td></td><td>•</td><td></td><td>•</td><td></td><td>•</td><td>•</td></tr> <tr><td>UH2011</td><td>•</td><td>•</td><td>•</td><td></td><td>•</td><td></td><td>•</td><td></td><td>•</td><td></td><td>•</td><td>•</td></tr> <tr><td>UH2013</td><td>•</td><td>•</td><td>•</td><td></td><td>•</td><td></td><td>•</td><td></td><td>•</td><td></td><td>•</td><td>•</td></tr> <tr><td>UH2016</td><td>•</td><td>•</td><td>•</td><td></td><td>•</td><td></td><td>•</td><td></td><td>•</td><td></td><td>•</td><td>•</td></tr> <tr><td>UL1413</td><td>•</td><td>•</td><td></td><td>•</td><td></td><td>•</td><td></td><td>•</td><td></td><td>•</td><td></td><td>•</td></tr> <tr><td>UL1415</td><td>•</td><td>•</td><td></td><td>•</td><td></td><td>•</td><td></td><td>•</td><td></td><td>•</td><td></td><td>•</td></tr> <tr><td>UL2009</td><td>•</td><td>•</td><td>•</td><td></td><td>•</td><td></td><td>•</td><td></td><td>•</td><td></td><td>•</td><td>•</td></tr> <tr><td>UL2011</td><td>•</td><td>•</td><td>•</td><td></td><td>•</td><td></td><td>•</td><td></td><td>•</td><td></td><td>•</td><td>•</td></tr> </tbody> </table>					For pumps fitting Interpump and Generalpump	Valves + caps		Seal packing		Intermediate ring + packing retainers				Complete seal packing		Oil seals	Plungers		Kit Dolly 123 ZX.0063	Kit Dolly 124 ZX.0166	Kit Dolly 160 ZX.0703	Kit Dolly 161 ZX.0704	Kit Dolly 164 ZX.0710	Kit Dolly 165 ZX.0711	Kit Dolly 162 ZX.0708	Kit Dolly 163 ZX.0709	Kit Dolly 166 ZX.0705	Kit Dolly 167 ZX.0706	Kit Dolly 159 ZX.0413	Dolly i3 CR.A1258	Dolly i4 CR.A1487	EH1413	•	•	•		•		•		•		•	•	EH1416	•	•	•		•		•		•		•	•	EH2009	•	•	•		•		•		•		•	•	EH2011	•	•	•		•		•		•		•	•	EL1411	•	•		•		•		•		•		•	EL1413	•	•		•		•		•		•		•	EL1714	•	•		•		•		•		•		•	EL2007	•	•	•		•		•		•		•	•	EL2009	•	•	•		•		•		•		•	•	UH2008	•	•	•		•		•		•		•	•	UH2011	•	•	•		•		•		•		•	•	UH2013	•	•	•		•		•		•		•	•	UH2016	•	•	•		•		•		•		•	•	UL1413	•	•		•		•		•		•		•	UL1415	•	•		•		•		•		•		•	UL2009	•	•	•		•		•		•		•	•	UL2011	•	•	•		•		•		•		•	•
For pumps fitting Interpump and Generalpump	Valves + caps		Seal packing		Intermediate ring + packing retainers				Complete seal packing		Oil seals	Plungers																																																																																																																																																																																																																																																	
	Kit Dolly 123 ZX.0063	Kit Dolly 124 ZX.0166	Kit Dolly 160 ZX.0703	Kit Dolly 161 ZX.0704	Kit Dolly 164 ZX.0710	Kit Dolly 165 ZX.0711	Kit Dolly 162 ZX.0708	Kit Dolly 163 ZX.0709	Kit Dolly 166 ZX.0705	Kit Dolly 167 ZX.0706	Kit Dolly 159 ZX.0413	Dolly i3 CR.A1258	Dolly i4 CR.A1487																																																																																																																																																																																																																																																
EH1413	•	•	•		•		•		•		•	•																																																																																																																																																																																																																																																	
EH1416	•	•	•		•		•		•		•	•																																																																																																																																																																																																																																																	
EH2009	•	•	•		•		•		•		•	•																																																																																																																																																																																																																																																	
EH2011	•	•	•		•		•		•		•	•																																																																																																																																																																																																																																																	
EL1411	•	•		•		•		•		•		•																																																																																																																																																																																																																																																	
EL1413	•	•		•		•		•		•		•																																																																																																																																																																																																																																																	
EL1714	•	•		•		•		•		•		•																																																																																																																																																																																																																																																	
EL2007	•	•	•		•		•		•		•	•																																																																																																																																																																																																																																																	
EL2009	•	•	•		•		•		•		•	•																																																																																																																																																																																																																																																	
UH2008	•	•	•		•		•		•		•	•																																																																																																																																																																																																																																																	
UH2011	•	•	•		•		•		•		•	•																																																																																																																																																																																																																																																	
UH2013	•	•	•		•		•		•		•	•																																																																																																																																																																																																																																																	
UH2016	•	•	•		•		•		•		•	•																																																																																																																																																																																																																																																	
UL1413	•	•		•		•		•		•		•																																																																																																																																																																																																																																																	
UL1415	•	•		•		•		•		•		•																																																																																																																																																																																																																																																	
UL2009	•	•	•		•		•		•		•	•																																																																																																																																																																																																																																																	
UL2011	•	•	•		•		•		•		•	•																																																																																																																																																																																																																																																	
<p>CR.A1258 Dolly i3 ceramic plunger ø15x37,5</p>  <p>gr. 16 quantity oz. 0.6 1</p>	<p>CR.A1487 Dolly i4 ceramic plunger ø18x37,5</p>  <p>gr. 30 quantity oz. 1.1 1</p>																																																																																																																																																																																																																																																												

<p>ZX.0713 Kit Dolly 62 valves + O-Rings</p>  <p>gr. 180 oz. 6.4</p> <p>quantity 2x6</p>	<p>ZX.0087 Set Dolly 69 seal packing ø20</p>  <p>gr. 40 oz. 1.5</p> <p>quantity 3x3</p>	<p>ZX.0038 Kit Dolly 8 OLD h.p. seals ø20x35</p>  <p>gr. 30 oz. 1.1</p> <p>quantity 1x6</p>	<p>ZX.0041 Set Dolly 8 OLD-60HP h.p. seals ø20x35</p>  <p>gr. 255 oz. 9.0</p> <p>quantity 1x60</p>	<p>ZX.0288 Set Dolly 8 OLD-500HP h.p. seals ø20x35</p>  <p>gr. 3300 oz. 116.5</p> <p>quantity 1x500</p>	
<p>ZX.0086 Kit Dolly 8 high and low pressure seals ø20x35</p>  <p>gr. 40 oz. 1.5</p> <p>quantity 2x3</p>	<p>ZX.0533 Set Dolly 8-60LP l.p. seals ø20x35</p>  <p>gr. 3300 oz. 116.5</p> <p>quantity 1x60</p>	<p>ZX.0308 Set Dolly 8-500LP l.p. seals ø20x35</p>  <p>gr. 255 oz. 9.0</p> <p>quantity 1x500</p>	<p>ZX.0136 Kit Dolly 7 head rings ø20</p>  <p>gr. 20 oz. 0.8</p> <p>quantity 1x6</p>	<p>ZX.0523 Set Dolly 7-60 head rings ø20</p>  <p>gr. 125 oz. 4.5</p> <p>quantity 1x60</p>	<p>ZX.0325 Set Dolly 7-500 head rings ø20</p>  <p>gr. 1000 oz. 35.3</p> <p>quantity 1x500</p>
<p>ZX.0141 Kit Dolly 71 intermediate ring + restop ø20</p>  <p>gr. 145 oz. 5.2</p> <p>quantity 1x3</p>	<p>ZX.0712 Kit Dolly 57 packing retainers + O-Rings ø20</p>  <p>gr. 465 oz. 16.5</p> <p>quantity 2x3</p>	<p>ZX.0927 Set Dolly 57-50 OR O-Rings for kit Dolly 57</p>  <p>gr. 105 oz. 3.8</p> <p>quantity 1x50</p>	<p>ZX.0714 Kit Dolly 82 complete seal packing ø20</p>  <p>gr. 300 oz. 10.6</p> <p>quantity 7x1</p>		
<p>ZX.0069 Kit Dolly 37 plunger oil seals ø35x42x7</p>  <p>gr. 30 oz. 1.1</p> <p>quantity 1x3</p>	<p>ZX.0410 Kit Dolly 32 shaft oil seals ø35x52x8</p>  <p>gr. 50 oz. 1.8</p> <p>quantity 1x2</p>	<p>CR.A1979 Dolly i2 ceramic plunger ø20x50</p>  <p>14 mm 50 mm 20 mm</p> <p>gr. 30 oz. 1.1</p> <p>quantity 1</p>			

For pumps fitting	Valves		Seal packing + head rings		Intermediate ring + packing retainers		Complete seal packing		Oil seals		Plungers
	Kit Dolly 62 ZX.0713	Kit Dolly 69 ZX.0087	Kit Dolly 7 ZX.0136	Kit Dolly 71 ZX.0141	Kit Dolly 57 ZX.0712	Kit Dolly 82 ZX.0714	Kit Dolly 37 ZX.0069	Kit Dolly 32 ZX.0410	Dolly i2 CR.A1979		
Interpump:											
WS104	•	•	•	•	•	•	•	•	•	•	
WS153	•	•	•	•	•	•	•	•	•	•	
Generalpump:											
TS1041	•	•	•	•	•	•	•	•	•	•	
TS1531	•	•	•	•	•	•	•	•	•	•	

<p>ZX.0693 Kit Dolly 43 valves + O-Rings</p>  <p>gr. 410 oz. 14.5</p> <p>quantity 2x6</p>	<p>ZX.0698 Kit Dolly 113 seal packing ø30</p>  <p>gr. 75 oz. 2.7</p> <p>quantity 3x3</p>	<p>ZX.0696 Kit Dolly 79 seal packing ø45</p>  <p>gr. 85 oz. 3.0</p> <p>quantity 3x3</p>	<p>ZX.0760 Kit Dolly 65 head rings ø30</p>  <p>gr. 30 oz. 1.1</p> <p>quantity 1x6</p>	<p>ZX.0763 Kit Dolly 48 head rings ø45</p>  <p>gr. 40 oz. 1.5</p> <p>quantity 1x6</p>
<p>ZX.0761 Kit Dolly 66 intermediate ring ø30</p>  <p>gr. 260 oz. 9.2</p> <p>quantity 1x3</p>	<p>ZX.0765 Kit Dolly 81 intermediate ring + restop ø45</p>  <p>gr. 380 oz. 13.5</p> <p>quantity 2x3</p>	<p>ZX.0762 Kit Dolly 114 packing retainers + O-Rings ø45</p>  <p>gr. 750 oz. 26.5</p> <p>quantity 2x3</p>	<p>ZX.0764 Kit Dolly 47 packing retainers + O-Rings ø45</p>  <p>gr. 400 oz. 14.2</p> <p>quantity 2x3</p>	
<p>ZX.0699 Kit Dolly 115 complete seal packing ø30</p>  <p>gr. 450 oz. 15.9</p> <p>quantity 7x1</p>	<p>ZX.0697 Kit Dolly 80 complete seal packing ø45</p>  <p>gr. 290 oz. 10.3</p> <p>quantity 7x1</p>	<p>ZX.0070 Kit Dolly 44 plunger oil seals ø35x52x7</p>  <p>gr. 65 oz. 2.3</p> <p>quantity 1x3</p>	<p>ZX.0410 Kit Dolly 32 shaft oil seals ø35x52x8</p>  <p>gr. 50 oz. 1.8</p> <p>quantity 1x2</p>	

CDR.0643
Dolly i8
ceramic
plunger
ø30x70



22 mm
70 mm
30 mm

gr. 175
oz. 6.3

quantità
1

CDR.0644
Dolly i9
ceramic
plunger
ø45x70



22 mm
70 mm
45 mm

gr. 310
oz. 11.0

quantity
1

	Valves	Seal packing + head rings				Intermediate ring + packing retainers				Complete seal packing		Oil seals		Plungers	
<i>For pumps fitting</i>	Kit Dolly 43 ZX.0693	Kit Dolly 113 ZX.0698	Kit Dolly 79 ZX.0696	Kit Dolly 65 ZX.0760	Kit Dolly 48 ZX.0763	Kit Dolly 66 ZX.0761	Kit Dolly 47 ZX.0765	Kit Dolly 114 ZX.0762	Kit Dolly 47 ZX.0764	Kit Dolly 115 ZX.0699	Kit Dolly 80 ZX.0697	Kit Dolly 44 ZX.0070	Kit Dolly 32 ZX.0410	Dolly i8 CDR.0643	Dolly i9 CDR.0644
Interpump:															
W6	•		•		•		•		•		•	•	•		•
W8	•		•		•		•		•		•	•	•		•
W12	•		•		•		•		•		•	•	•		•
W15	•		•		•		•		•		•	•	•		•
W155	•	•		•		•		•		•		•	•	•	
W159	•	•		•		•		•		•		•	•	•	
Generalpump:															
T61	•		•		•		•		•		•	•	•		•
T81	•		•		•		•		•		•	•	•		•
T121	•		•		•		•		•		•	•	•		•
T151	•		•		•		•		•		•	•	•		•
T1551	•	•		•		•		•		•		•	•	•	
T1591	•	•		•		•		•		•		•	•	•	

<p>ZX.0040 Kit Dolly 1 valves + O-Rings</p>  <p>gr. 85 oz. 3.0</p> <p>quantity 2x6</p>	<p>ZX.0048 Set Dolly 1-30 valves + O-Rings</p>  <p>gr. 390 oz. 13.8</p> <p>quantity 2x30</p>	<p>ZX.0287 Set Dolly 1-500 valves + O-Rings</p>  <p>gr. 6700 oz. 236.6</p> <p>quantity 2x500</p>	<p>ZX.0579 Set Dolly 1/123-50 OR O-Rings for Kit Dolly 1 and 123</p>  <p>gr. 22 oz. 0.8</p> <p>quantity 1x50</p>	<p>ZX.0717 Kit Dolly 134 valves + O-Rings</p>  <p>gr. 30 oz. 1.1</p> <p>quantity 2x6</p>
<p>ZX.0716 Kit Dolly 87 seal packing ø15</p>  <p>gr. 20 oz. 0.8</p> <p>quantity 4x3</p>	<p>ZX.0535 Kit Dolly 97 seal packing ø15</p>  <p>gr. 15 oz. 0.6</p> <p>quantity 4x3</p>	<p>ZX.0047 Set Dolly 97-60HP h.p. seals ø15x25</p>  <p>gr. 100 oz. 3.6</p> <p>quantity 1x60</p>	<p>ZX.0402 Set Dolly 97-500HP h.p. seals ø15x25</p>  <p>gr. 3300 oz. 116.5</p> <p>quantity 1x500</p>	
<p>ZX.0645 Kit Dolly 86 packing retainers + O-Rings ø15</p>  <p>gr. 90 oz. 3.2</p> <p>quantity 3x3</p>	<p>ZX.0718 Kit Dolly 146 complete seal packing ø12</p>  <p>gr. 30 oz. 1.1</p> <p>quantity 5x3</p>	<p>ZX.0715 Kit Dolly 85 complete seal packing ø15</p>  <p>gr. 40 oz. 1.5</p> <p>quantity 5x1</p>	<p>ZX.0644 Kit Dolly 96 complete seal packing ø15</p>  <p>gr. 40 oz. 1.5</p> <p>quantity 5x1</p>	
<p>ZX.0728 Kit Dolly 147 piston oil seals ø12x22x4/6</p>  <p>gr. 15 oz. 0.6</p> <p>quantity 1x3</p>	<p>ZX.0065 Kit Dolly 83 piston oil seals ø15x24x5</p>  <p>gr. 25 oz. 0.9</p> <p>quantity 1x3</p>	<p>FLM.0005 Dolly i6 ceramic plunger ø15x25</p>  <p>9 mm 25 mm 15 mm</p> <p>gr. 15 oz. 0.6</p> <p>quantity 1</p>	<p>CDR.0641 Dolly i11 piston unit ø12x62,5</p>  <p>62,5 mm 12 mm</p> <p>gr. 20 oz. 0.8</p> <p>quantity 1</p>	



*“We are able to supply all spare parts
to repair any high pressure washer
which was manufactured in Italy
during the last 20 years”*

For power units fitting Interpump		Valves		Seal packing		Packing retainers	Complete seal packing			Oil seals		Plungers	
Series	Model	Kit Dolly 1 ZX.0040	Kit Dolly 134 ZX.0717	Kit Dolly 87 ZX.0716	Kit Dolly 97 ZX.0535	Kit Dolly 86 ZX.0645	Kit Dolly 146 ZX.0718	Kit Dolly 85 ZX.0715	Kit Dolly 96 ZX.0644	Kit Dolly 147 ZX.0728	Kit Dolly 83 ZX.0065	Dolly i6 FLM.0005	Dolly i11 CDR.0641
BOXJET	8.70	•		•		•		•			•	•	
	8.90	•		•		•		•			•	•	
	11.50	•		•		•		•			•	•	
	TURBO 15	•		•		•		•			•	•	
	TURBO 19	•		•		•		•			•	•	
	TURBO 21	•		•		•		•			•	•	
BIG BANG FORMULA 99 GONG FLASH	F.122	•		•		•		•			•	•	
	F.124	•		•		•		•			•	•	
	X.117S	•		•		•		•			•	•	
	X.161	•		•		•		•			•	•	
	X.220S	•		•		•		•			•	•	
	X.230	•		•		•		•			•	•	
	X.240S	•		•		•		•			•	•	
TURBO	15	•			•	•			•		•	•	
	19	•			•	•			•		•	•	
	21	•			•	•			•		•	•	
	8.70	•			•	•			•		•	•	
	8.90	•			•	•			•		•	•	
	10.100	•			•	•			•		•	•	
	11.50	•			•	•			•		•	•	
	11.70	•			•	•			•		•	•	
	11.120	•			•	•			•		•	•	
	13.90	•			•	•			•		•	•	
CLEANMATIC	CL 10		•				•			•			•
	CL 11		•				•			•			•
	CL 22		•				•			•			•
	CL 24		•				•			•			•
	CL 26		•				•			•			•
GREEN JET	GX 10		•				•			•			•
	GX 11		•				•			•			•
	GX 22		•				•			•			•
	GX 24		•				•			•			•
	GX 26		•				•			•			•
BLUE TIME	BT 10		•				•			•			•
	BT 12		•				•			•			•
	BT 22		•				•			•			•
	BT 24		•				•			•			•
	BT 26		•				•			•			•



Plunger oil seals

Code	Description	Dimensions	Weight
ZX.0194	Set Dolly L1 (quantity 1x15) fitting: Annovi Reverberi, Comet, Generalpump, Interpump, Idromecc. Bertolini	ø15x24x5	gr. 50 oz. 1.8
ZX.0195	Set Dolly L2 (quantity 1x15) fitting : Annovi Reverberi,	ø20x28x6	gr. 70 oz. 2.5
ZX.0196	Set Dolly L3 (quantity 1x15) fitting: Comet, Generalpump, Interpump	ø20x30x5	gr. 70 oz. 2.5
ZX.0197	Set Dolly L4 (quantity 1x15) fitting: Generalpump, Interpump	ø22x35x7	gr. 120 oz. 4.3
ZX.0198	Set Dolly L5 (quantity 1x15) fitting: Generalpump, Interpump	ø32x42x7	gr. 240 oz. 8.5
ZX.0199	Set Dolly L6 (quantity 1x15) fitting: Generalpump, Interpump, Idromecc. Bertolini	ø35x52x7	gr. 130 oz. 4.6
ZX.0201	Set Dolly L8 (quantity 1x15) fitting: Leuco / Hawk, Idromecc. Bertolini	ø16x24x5	gr. 50 oz. 1.8
ZX.0202	Set Dolly L9 (quantity 1x15) fitting: Faip, Leuco / Hawk	ø20x30x7	gr. 90 oz. 3.2
ZX.0211	Set Dolly L10 (quantity 1x15) fitting: Generalpump, Interpump	ø22x32x5,5	gr. 100 oz. 3.6

Shaft oil seals

Code	Description	Dimensions	Weight
ZX.0203	Set Dolly M1 (quantity 1x10) fitting: Generalpump, Interpump, Leuco / Hawk	ø30x55x7	gr. 200 oz. 7.1
ZX.0204	Set Dolly M2 (quantity 1x5) fitting: Annovi Reverberi	ø25x45x10	gr. 105 oz. 3.8
ZX.0205	Set Dolly M3 (quantity 1x5) fitting: Annovi Reverberi, Comet, Generalpump	ø25x52x7	gr. 90 oz. 3.2
ZX.0206	Set Dolly M4 (quantity 1x5) fitting: Annovi Reverberi	ø30x42x7	gr. 60 oz. 2.2
ZX.0207	Set Dolly M5 (quantity 1x5) fitting: Generalpump, Interpump, Leuco / Hawk	ø25x42x7	gr. 75 oz. 2.7
ZX.0208	Set Dolly M6 (quantity 1x5) fitting: Faip, Leuco / Hawk	ø25x47x7	gr. 80 oz. 2.9
ZX.0209	Set Dolly M7 (quantity 1x5) fitting: Comet, Leuco / Hawk, Interpump	ø25x62x10	gr. 170 oz. 6.0
ZX.0210	Set Dolly M8 (quantity 1x5) fitting: Lavor	ø20x35x6	gr. 60 oz. 2.2
ZX.0471	Set Dolly M9 (quantity 1x5) fitting: Generalpump, Interpump series 63	ø45x62x8	gr. 80 oz. 2.8
ZX.1133	Set Dolly M10 (quantity 1x5) fitting: Annovi Reverberi series XT	ø40x52x7	gr. 120 oz. 4.2



IDROBASE[®]

PASSION FOR WATER



Accessories and components for h.p. washers

- INDEX

Subject	Page
H.p. pumps	150
Motor-pump:	152
• Pressure gauges	153
• Detergent injectors and filters	153
• Electric motors	153
• Motor-pump groups 1450 Rpm	154
• Motor-pump groups 2800 Rpm	154
• Components	154
• Check valves, regulators and safety valves	155
• Inlet water filters	156
Unloader valves:	158
• By-pass and bolt unloader valves	158
Heating systems:	162
• Dolly electrodes	163
• Pressure switches	164
• Transformers and accessories	165
• Fuel nozzles and filters	166
• Fuel pumps and spare parts	168
• CdR coils	172
• Thermostats and burner motors	173
• Heating systems	173
H.p. hoses:	177
• H.p. hoses: technical features table	178
• H.p. hoses 210 bar-3050 psi R1 1/4" - pre-assembled	180
• H.p. hoses 210 bar-3050 psi R1 3/8" - pre-assembled	183
• H.p. hoses 315 bar-4550 psi R1 5/16" - pre-assembled	186
• H.p. hoses 400 bar-5800 psi R2 5/16" - pre-assembled	190
• H.p. hoses 400 bar-5800 psi R2 3/8" - pre-assembled	193
• H.p. hoses 500 bar-7250 psi R2 3/8" - pre-assembled	194
• H.p. hoses R1 1/4" and fittings	196
• H.p. hoses R1 and R2 5/16" and fittings	198
• H.p. hoses R1 and R2 3/8" and fittings	199
• H.p. hoses R2 3/8" 500 bar-7250 psi and fittings	200
• H.p. sewer hose 210 bar-3050 psi - R7 3/16"	200
• H.p. thermoplastic hose 140 bar-2000 psi - 1/4"	201
• H.p. hoses - made to measure (order form)	205
Spray guns:	205
• Spray guns, inlet G 3/8" F	205
• Spray guns, inlet M 22x1,5" M	208
• Spray guns with extensions	208
Lances and extension lances:	206
• Lances, inlet G 3/8" F	208
• Lances, inlet M 22x1,5" F	209
• Double lances and lance extensions	209
Nozzles:	210
• Table for the suitable nozzle	211
• H.p. nozzles, NPT-M	212
• Tip nozzles	212
• Nozzle holders	213
• Quick nozzles	213
• Nozzles - rotating brush	214
• L.p. nozzles	214
• Variable angle nozzles + Hi-Lo function	214
• Sand blast nozzles	215
• Rotating nozzles	216
• Sewer nozzles	216
Nebulizers:	219
• Foam lances	222
• Air - painted steel	223
• Air - stainless steel	224
• Electric - fixed	225
• Electric - wheeled	226
• H.p. foam kit	227
• Accessories	227
Electric components	229
Quick couplings:	230
• Balls	231
• Screw M 22	232
• Screw swivel	232
• Screw M 22 LONG	232
• Screw M 24	233
• Swivel	233
• Water inlet	233
Accessories for food industries - Ball valves	234
Hose-reel - Carwash swivel couplings	235
Connections:	236
• Low pressure	237
• High pressure	237
500 bar accessories and components	240
Easy puzzle:	244
• Frame set, electric boxes and wheels	244
Hobby h.p. washers accessories:	245
Dolly O-Rings:	248
• Fitting Kärcher	248
• Fitting Interpump / Generalpump	249
• For quick couplings	249
Consumer items	250
• Washers	251
• Threadlocking and threadsealing	251

High pressure pumps - Idrobase

**MADE
IN ITALY**

These pumps embrace 25 years of experience in the high pressure washers field. High quality pressure pumps for continuous use. Main technical features: crankshaft, brass head, 3 ceramic pistons.

1000 Rpm



Code	Model	Pressure	Flow rate	HP max	Shaft	Weight
CDR.5019	RN 200-11	200 bar 2900 psi	11 l/min 2.90 USGpm	5,5	left	gr. 11500 oz. 406.0
CDR.5020	RN 200-15	200 bar 2900 psi	15 l/min 4.00 USGpm	7,5	left	gr. 11500 oz. 406.0

RN pump series can be applied directly to all types of electric motors with hollow shaft. Main characteristic is: reversible construction that allows rapid transformation from right to left pump and vice versa.
Extreme reliability for medium to long periods.
Solid shaft ø24 mm.

1450 Rpm

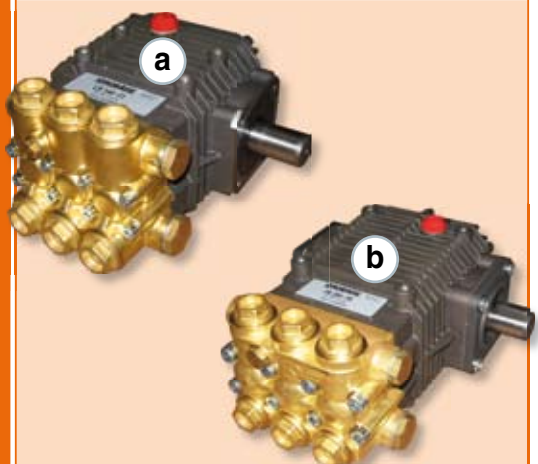

Code	Model	Pressure	Flow rate	HP max	Shaft	Weight
a) CDR.5012	LS 140-8	140 bar 2000 psi	8 l/min 2.11 USGpm	3	Right	gr. 6100 oz. 215.0
a) CDR.5000	LS 140-11	140 bar 2000 psi	11 l/min 2.90 USGpm	4	Right	gr. 6100 oz. 215.0
b) CDR.5001	FS 150-15	150 bar 2200 psi	15 l/min 4.00 USGpm	5,5	Right	gr. 8300 oz. 293.0
b) CDR.5003	FS 150-21	150 bar 2200 psi	21 l/min 5.50 USGpm	7,5	Right	gr. 8800 oz. 311.0
b) CDR.5010	FS 200-15	200 bar 2900 psi	15 l/min 4.00 USGpm	7,5	Right	gr. 8800 oz. 311.0
b) CDR.5015	FS 200-21	200 bar 2900 psi	21 l/min 5.50 USGpm	10	Right	gr. 8800 oz. 311.0

LS and FS pump series can be applied directly to all types of electric motors with hollow shaft. Main characteristic is: reversible construction that allows rapid transformation from right to left pump and vice versa.
Solid shaft ø24 mm.



Code	Model	Pressure	Flow rate	HP max	Shaft	Weight
c) CDR.5011	SS 275-21	275 bar 4000 psi	11 l/min 2.90 USGpm	14,5	Right	gr. 18000 oz. 635.0
d) CDR.5005	TS 170-42	170 bar 2450 psi	42 l/min 11.00 USGpm	18	Right	gr. 20000 oz. 706.0
d) CDR.5006	TS 200-33	200 bar 2900 psi	33 l/min 8.70 USGpm	17	Right	gr. 20000 oz. 706.0
d) CDR.5004	TS 250-26	250 bar 3600 psi	26 l/min 6.80 USGpm	16,5	Right	gr. 20000 oz. 706.0
d) CDR.5014	TS 345-18	345 bar 5000 psi	18 l/min 4.70 USGpm	16	Right	gr. 20000 oz. 706.0

SS and TS pump series can be applied directly to all types of electric motors with hollow shaft. Main characteristic is: the very high quality of pressure seals for heavy duty, long term use.
Solid shaft ø24 mm.

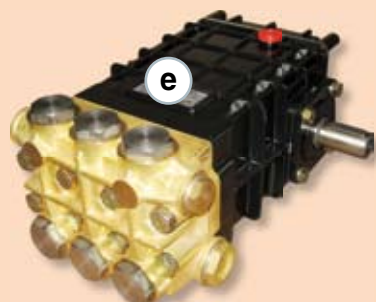

Code	Model	Pressure	Flow rate	HP max	Shaft	Weight
e) CDR.5021	GKC 21/35S	350 bar 2900 psi	21 l/min 5.50 USGpm	18,8	Right	gr. 17300 oz. 610.0

GKC and GHC pump series can be applied directly to all types of electric motors with hollow shaft. Main characteristic is: to sustain high pressure for heavy duty use during long periods.
Solid shaft ø24 mm.

High pressure pumps - Idrobase

**MADE
IN ITALY**

These pumps embrace 25 years of experience in the high pressure washers field. High quality pressure pumps for continuous use. Main technical features: crankshaft, brass head, 3 ceramic pistons.

3400 Rpm



Code	Model	Pressure	Flow rate	HP max	Shaft	Weight
CDR.5013	FD 210-17	210 bar 3000 psi	17 l/min 4.50 USGpm	10	Right	gr. 6100 oz. 215.0

*FD pump series can be applied directly to all types of petrol engines.
Main characteristic is: reversible construction that allows rapid transformation from right to left pump and vice versa.
Hollow shaft ø1".*

High pressure pumps - Conversion table

Idrobase pumps Code Model	Manufacturers / Model of pump						
	ANNOVI REVERBERI	IDROMECC. BERTOLINI	COMET	GENERALPUMP	LEUCO / HAWK	INTERPUMP	UDOR
CDR.5019 RN 200-11			RN 200-11				
CDR.5020 RN 200-15			RN 200-15			W201	
CDR.5012 LS 140-8	XT 8.14	WBL 813	LW 3020		HC310	W150	PNC 09/15 S
CDR.5000 LS 140-11	XT 11.14 N	WML 1214	LW 3020	EL1411	HC350	EL1411	PNC 11/11 S
CDR.5001 FS 150-15	RK 15.15 XM 15.15 XW 15.15	TW 15/150	FW 4022 S	TS1511	HC506I	WS151	MC 15/15 S
CDR.5003 FS 150-21	RK 21.15 H	TML 2015	FW 5522 S	TS1521		WS152	MC 20/15 S
CDR.5010 FS 200-15	RK 15.20 H SXM 15.20 XW 15.20 N	TML 1520	FW 4030	TS2011	HC506I	WS201	MC 15/20
CDR.5011 SS 275-21	XV 21.28 N	TNL 2028-HP	SW 5540 S		HC800	WS2525	GKC 21/28S
CDR.5005 TS 170-42	XWL 42.15 N		TW 11025 S	TS1351	HC960	WS135	GC 34/17 S GC 52/14 S
CDR.5006 TS 200-33	XW 30.20 N		TW 8030 S	TSF2221-ALT	HC800	W2035	GC 30/20 S
CDR.5004 TS 250-26	XW 26.23 N		TW 7036 S	TSF2021	PM56	W2525	GKC 26/08 S
CDR.5014 TS 345-18	SXW 15.35 N		TW 4550	TSP1819	HC932	W4015	GKC 17/35 S
CDR.5021 GKC 21/35 S	SXW 21.35 N		TW 5550 S	TSP1621		W3521	GKC 21/35 S
CDR.5022 GHC 16/50 S	SHP 15.50 N					W5015	GKC 16/50 S
CDR.5013 FD 210-17	RKV 4 G32 D+F24	TWSG 3016	FWD 4530	EZ3045G	PS345G	WW964C 1"	ML 5.0/30-W



Motor-pump - Stainless steel pressure gauge

The spare parts branded "CdR" exclusively refer to products by Club dei Riparatori® by IDROBASE®

Back entry



ATTENTION !!! To avoid damages, we recommend that you mount pressure gauges reading **twice** of working pressure of the pump.



Professional gauge, case and ring made of stainless steel AISI 304, temperature -20 °C (-40 °F) +80 °C (+170 °F). Scale: bar (black), psi (red).

Flange and fixing bracket



Flanges made of stainless steel and fixing brackets made of tropicalized steel for ø50-2.0" and ø63-2.5" pressure gauges.

Bottom entry



ATTENTION !!! To avoid damages, we recommend that you mount pressure gauges reading **twice** of working pressure of the pump..



Professional gauge, case and ring made of stainless steel AISI 304, temperature -20 °C (-40 °F) +80 °C (+170 °F). Scale: bar (black), psi (red).

Hoses for gauges



Made of Micro-hose with polyamide core tube and jacket, highly resistant synthetic fibre braid. With protection caps. 250 bar-3600 psi, 150 °C-300 °F.

Hoses for gauges fitting Kärcher

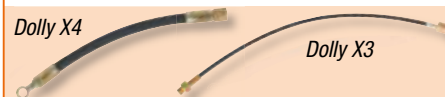

Dolly X4, for hot water pressure washers manufactured before 1992. Dolly X3, for hot water pressure washers manufactured after 1992.

Code	ø	Inlet	Scale	Weight	
CDR.7SS401N1P	40 mm 1.5"	1/8" M-BSPT	0-160 bar 0-2300 psi	gr.	100
CDR.7SS403N1P	40 mm 1.5"	1/8" M-BSPT	0-300 bar 0-4300 psi	gr.	100
CDR.7SS501N2P	50 mm 2.0"	1/4" M-BSPT	0-160 bar 0-2300 psi	gr.	160
CDR.7SS502N2P	50 mm 2.0"	1/4" M-BSPT	0-250 bar 0-3600 psi	gr.	160
CDR.7SS504N2P	50 mm 2.0"	1/4" M-BSPT	0-315 bar 0-4500 psi	gr.	160
CDR.7SS632N2P	63 mm 2.5"	1/4" M-BSPT	0-250 bar 0-3600 psi	gr.	220
CDR.7SS634N2P	63 mm 2.5"	1/4" M-BSPT	0-315 bar 0-4500 psi	gr.	220
CDR.7SS635N2P	63 mm 2.5"	1/4" M-BSPT	0-400 bar 0-5800 psi	gr.	220









Code	ø	Description	Weight	
CDR.7259	50 mm 2.0"	Fixing bracket	gr.	26
CDR.7316	50 mm 2.0"	Flange	gr.	16
CDR.7249	63 mm 2.5"	Fixing bracket	gr.	36
CDR.7248	63 mm 2.5"	Flange	gr.	22

Code	ø	Inlet	Scale	Weight	
CDR.7SS501N2R	50 mm 2.0"	1/4" M-BSPT	0-160 bar 0-2300 psi	gr.	160
CDR.7SS502N2R	50 mm 2.0"	1/4" M-BSPT	0-250 bar 0-3600 psi	gr.	160
CDR.7SS504N2R	50 mm 2.0"	1/4" M-BSPT	0-315 bar 0-4500 psi	gr.	160
CDR.7SS505N2R	50 mm 2.0"	1/4" M-BSPT	0-400 bar 0-5800 psi	gr.	160
CDR.7SS631N2R	63 mm 2.5"	1/4" M-BSPT	0-160 bar 0-2300 psi	gr.	220
CDR.7SS632N2R	63 mm 2.5"	1/4" M-BSPT	0-250 bar 0-3600 psi	gr.	220
CDR.7SS634N2R	63 mm 2.5"	1/4" M-BSPT	0-315 bar 0-4500 psi	gr.	220
CDR.7SS635N2R	63 mm 2.5"	1/4" M-BSPT	0-400 bar 0-5800 psi	gr.	220
CDR.0110	63 mm 2.5"	1/4" M-BSPT	0-6 bar 0-87 psi	gr.	220

Code	Length	Inlet	Outlet	Weight	
OT.0001	300 mm 11.80"	G 1/4" F	G 1/4" F	gr.	60
OT.0002	500 mm 19.70"	G 1/4" F	G 1/4" F	gr.	65
OT.0003	700 mm 27.60"	G 1/4" F	G 1/4" F	gr.	70

Code	Length	Inlet	Outlet	Weight	
CF.0059 (Dolly X4)	290 mm 11.45"		G 1/4" F	gr.	150
OT.0004 (Dolly X3)	405 mm 15.90"	M 10x1 M	M 12x1,5 F	gr.	50

Motor-pump - Detergent injectors





<p>CDR.0384</p> <p>Chemical restrictor valve, equipped with proportional regulation control. 28 bar-405 psi, 10 l/min-2.64 USGpm, 40 °C-105 °F</p> 	<p>CDR.0385</p> <p>Chemical restrictor valve, equipped with proportional regulation control. 0,5 bar-7 psi, 1 l/min-0.25 USGpm, 60 °C-140 °F</p> 	<p>CDR.1250</p> <p>Chemical restrictor valve, made of brass, 10 l/min-3.00 USGpm, 30 bar-440 psi, 40 °C-100 °F</p> 	<p>CDR.1251</p> <p>Chemical restrictor valve - "L", made of brass, 10 l/min-3.00 USGpm, 30 bar-440 psi, 40 °C-100 °F</p> 				
gr. 215 oz. 7.6	Inlet G 1/4" M equipped with ø7 mm hose-barb	gr. 60 oz. 2.2	Chemical inlet for 2 different products, inlet ø7 mm hose-barb	gr. 160 oz. 5.7	Inlet G 1/4" M Outlet G 1/4" M	gr. 160 oz. 5.7	Inlet G 1/4" M Outlet G 1/4" M
<p>CDR.0898</p> <p>Fixed detergent injector ø1.8, made of brass, 8-10 l/min 2.11-2.64 USGpm 220 bar-3200 psi, 90 °C-195 °F</p> 	<p>CDR.0899</p> <p>Fixed detergent injector ø2.1, made of brass, 11-15 l/min 2.90-4.00 USGpm 220 bar-3200 psi, 90 °C-195 °F</p> 	<p>CDR.0900</p> <p>Adjustable detergent injector ø1.8, made of brass, 8-10 l/min 2.11-2.64 USGpm 220 bar-3200 psi, 90 °C-195 °F</p> 	<p>CDR.0901</p> <p>Adjustable detergent injector ø2.1, made of brass, 11-15 l/min 2.90-4.00 USGpm 220 bar-3200 psi, 90 °C-195 °F</p> 	<p>CDR.0902</p> <p>Adjustable detergent injector ø2.3, made of brass, 15-18 l/min 4.00-4.75 USGpm 220 bar-3200 psi, 90 °C-195 °F</p> 			
gr. 120 oz. 4.3	Inlet G 3/8" F Outlet G 3/8" M	gr. 120 oz. 4.3	Inlet G 3/8" F Outlet G 3/8" M	gr. 160 oz. 5.7	Inlet G 3/8" F Outlet G 3/8" M	gr. 160 oz. 5.7	Inlet G 3/8" F Outlet G 3/8" M

Motor-pump - Detergent filters

<p>MV.211000021</p> <p>Stainless steel detergent intake strainer, MV13</p> 	<p>CDR.7333</p> <p>Stainless steel detergent intake strainer, with check valve</p> 	<p>CDR.7332</p> <p>Plastic detergent intake strainer,</p> 	<p>CDR.7331</p> <p>Plastic detergent intake strainer, with check valve</p> 	<p>CDR.0550</p> <p>Transparent hose, ø7x10 mm-0.28x0.39", strainer - injector connection</p> 					
gr. 15 oz. 0.6	ø7 mm-0.28" hose-barb	gr. 47 oz. 1.7	ø7 mm-0.28" hose-barb	gr. 12 oz. 0.5	ø6 mm-0.24" hose-barb	gr. 14 oz. 0.5	ø8 mm-0.32" hose-barb	gr. 110 oz. 3.9	Price per metre







Motor-pump - Electric motor and motor set

Professional motors and motor set. Insulation class S1.
Hollow shaft ø24mm.
Please specify in the order which model of pump you have to connect.

<p>ML.131922M001</p> <p>Electric motor 3 HP, 1450 Rpm 1x240 V 50 Hz,</p> 	<p>ML.131922T078</p> <p>Electric motor 5,5 HP, 1450 Rpm 3x400 V 50 Hz,</p> 	<p>ML.131922T010</p> <p>Electric motor 5,5 HP, 1450 Rpm 3x400 V 50 Hz,</p> 			
gr. 22000 oz. 777.0	ø 90 mm centring	gr. 22500 oz. 795.0	ø 61 mm centring	gr. 22500 oz. 795.0	ø 90 mm centring
<p>ML.131922T077</p> <p>Electric motor 7,5 HP, 1450 Rpm 3x400 V 50 Hz,</p> 	<p>ML.131922T009</p> <p>Electric motor 7,5 HP, 1450 Rpm 3x400 V 50 Hz,</p> 				
gr. 31500 oz. 1,112.0	ø 61 mm centring	gr. 31500 oz. 1,112.0	ø 90 mm centring		



Motor-pump

- Groups with crankshaft pump 1450 Rpm

<p>ZX.1013 Motor-pump group 3 HP, 1450 Rpm, 1x240 V 50 Hz, 140 bar 2000 psi, 8 l/min-2.11 USGpm</p>  <p>gr. 31100 oz. 1,098.0</p>	<p>ZX.1011 Motor-pump group 3 HP, 1450 Rpm, 1x240 V 50 Hz, 110 bar 1600 psi, 11 l/min-2.90 USGpm</p>  <p>gr. 31100 oz. 1,098.0</p>	<p>ZX.0115 Motor-pump group 5,5 HP, 1450 Rpm, 3x400 V 50 Hz, 150 bar 2200 psi, 15 l/min-4.00 USGpm</p>  <p>gr. 33800 oz. 1,193.0</p>	<p>ZX.1520 Motor-pump group 7,5 HP, 1450 Rpm, 3x400 V 50 Hz, 200 bar 2900 psi, 15 l/min-4.00 USGpm</p>  <p>gr. 43300 oz. 1,529.0</p>
<p>ZX.1522 Motor-pump group 7,5 HP, 1450 Rpm, 3x400 V-50 Hz, 150 bar 2200 psi, 21 l/min 5.50 USGpm</p>  <p>gr. 43300 oz. 1,529.0</p>	<p>ZX.1523 Motor-pump group 10 HP, 1450 Rpm, 3x400 V-50 Hz, 190 bar 2755 psi, 21 l/min 5.50 USGpm</p>  <p>gr. 52500 oz. 1,838.0</p>	<p>Pre-assembled and tested professional motor pump group complete with:</p> <ul style="list-style-type: none"> - Professional electric motor set, with electrical box IP55, thermal-magnetic switch and 5m electric cable. - Idrobase professional crankshaft pump, 3 ceramic pistons, brass head, bolt unloader valve, detergent injector with intake strainer filter and connection hose, stainless steel pressure gauge with glycerin and water inlet i.p. quick coupling with filter. 	











Motor-pump

- Groups with axial pump 2800 Rpm









<p>W.7301.0275 Motor-pump group 3 HP, 2800 Rpm, 1x240 V-50 Hz, 130 bar 1900 psi, 9 l/min 2.40 USGpm</p>  <p>gr. 20800 oz. 735.0</p>	<p>W.7301.0276 Motor-pump group 5 HP, 2800 Rpm, 3x400 V-50 Hz, 170 bar 2450 psi, 11 l/min 2.90 USGpm</p>  <p>gr. 22800 oz. 805.0</p>	<p>Pre-assembled and tested motor-pump group complete with:</p>  <ul style="list-style-type: none"> - 2800 Rpm axial motor-pump, 3 pistons with terminal part in ceramic, brass head, bolt unloader valve, pressure gauge in glycerin bath, thermal protection valve and inlet water quick coupling made of ABS. 	
---	---	--	--

Motor-pump

- Components

<p>M.00010100 Float valve, G 3/4" M,</p>  <p>gr. 100 oz. 3.6</p> <p>max 10 bar-145 psi max 60 °C-140 °F</p>	<p>CDR.0893 Brass Float valve, G 3/4" M, flow rate: 1 bar-15 psi > 20 l/min-5.30 USGpm 2 bar-29 psi > 29 l/min-7.50 USGpm</p>  <p>gr. 260 oz. 9.1</p> <p>max 10 bar-145 psi max 60 °C-140 °F</p>	<p>MV.0210000010 Water tank made of PPL, with cover and bulkhead</p>  <p>Dimensions W - 120 mm-4.7" L - 210 mm-8.3" H - 205 mm-8,1"</p> <p>Capacity 3 lt - 0.8 USG</p>	<p>S.LI0110SA Shock absorber 0.1 l, 330 bar-4800 psi, inlet G 3/8" F, -20+80 °C (-4+175 °F)</p>  <p>Body made of forged steel, gas filling (nitrogen)</p> <p>gr. 1800 oz. 63.6</p> <p>Mounting: vertical or horizontal</p>	<p>S.L103510SA Shock absorber 0.35 l, 330 bar-4800 psi, inlet G 3/8" F, -20+80 °C (-4+175 °F)</p>  <p>Body made of forged steel, gas filling (nitrogen)</p> <p>gr. 2950 oz. 104.2</p> <p>Mounting: vertical or horizontal</p>	
<p>CDR.0021 Antiscale device, inlet G 1/2" F, outlet G 1/2" M</p>  <p>gr. 360 oz. 12.7</p> <p>Made of brass</p>	<p>CDR.0022 Antiscale device, inlet G 3/4" F, outlet G 3/4" M</p>  <p>gr. 360 oz. 12.7</p> <p>Made of brass</p>	<p>MV.205010010 Horizontal flow switch, 250 bar-3600 psi, 30 l/min- 8.00 USGpm, 60 °C-140 °F, 12-250 V, 0,8 A</p>  <p>gr. 470 oz. 16.6</p> <p>G 3/8" F-F</p>	<p>CDR.0892 Flow switch with plastic probe, 250 bar-3600 psi, 30 l/min- 8.00 USGpm, 80 °C-175 °F, 230 V, 3 A, IP 55</p>  <p>gr. 275 oz. 9.7</p> <p>G 3/8" M-M</p>	<p>CDR.7002 Hose-barb, made of brass, inlet ø9 mm-0.35" outlet G 1/8" M</p>  <p>gr. 10 oz. 0.4</p>	<p>CDR.7003 Hose-barb, made of brass, inlet ø9 mm-0.35" outlet G 1/4" M</p>  <p>gr. 15 oz. 0.6</p>

Motor-pump - Check valves









<p>CDR.7172 Low pressure check valve, made of brass, G 3/8" F-F 25 bar-360 psi, 90 °C-195 °F</p> 	<p>CDR.7210 Stainless steel filter for l.p. check valve, G 3/8" F-F (code CDR.7172)</p> 	<p>CDR.7173 Low pressure check valve, made of brass, G 1/2" F-F 25 bar-360 psi, 90 °C-195 °F</p> 	<p>CDR.7211 Stainless steel filter for l.p. check valve, G 1/2" F-F (code CDR.7173)</p> 
gr. 140 oz. 5.0	gr. 10 oz. 0.4	gr. 120 oz. 4.3	gr. 12 oz. 0.5
<p>CDR.7174 Low pressure check valve, made of brass, G 3/4" F-F 25 bar-360 psi, 90 °C-195 °F</p> 	<p>CDR.7212 Stainless steel filter for l.p. check valve, G 3/4" F-F (code CDR.7174)</p> 	<p>CDR.0370 High pressure check valve, made of stainless steel, G 3/8" F-F, 400 bar-5800 psi, 40 l/min-10.50 USGpm, 90 °C-195 °F</p> 	<p>CDR.0383 High pressure check valve, made of stainless steel, G 1/2" F-F, 400 bar-5800 psi, 80 l/min-21.00 USGpm, 90 °C-195 °F</p> 
gr. 150 oz. 5.3	gr. 12 oz. 0.5	gr. 106 oz. 3.8	gr. 185 oz. 6.6

Motor-pump - Regulators

<p>CDR.0599 Thermal protection valve, operating temperature: 56 °C-135 °F</p> 	<p>CDR.0388 Vapour high pressure regulator valve 2.0, 250 bar-3600 psi, 30 l/min-8.00 USGpm, 150 °C 300 °F</p> 	<p>CDR.0553 Automatic Rpm regulator, for petrol engines. G 3/8" M</p> 
gr. 52 oz. 1.9 Inlet G 1/2" M	gr. 170 oz. 6.0 Inlet G 1/4" M Outlet G 1/4" M	gr. 200 oz. 7.1

Motor-pump - Safety valves

They are supplied NOT ADJUSTED. They become safety components once they have been adjusted and mounted on the machine by the installer.

<p>CDR.0031 Safety relief valve VS 28/2, 100-250 bar 1450-3650 psi, 12-16 l/min. 3.2-4.2 USGpm, 108 °C-225 °F, inlet G 1/4" M</p> 	<p>CDR.0032 Safety relief valve VS 28/3, 100-250 bar 1450-3650 psi, 16-19.5 l/min. 4.2-5.15 USGpm, 108 °C-225 °F, inlet G 1/4" M</p> 	<p>P.60.0560.00 Safety relief valve VS 160, hose-barb ø13 mm-0.51", 160 bar-2300 psi, 14 l/min 3.70 USGpm, 90 °C-195 °F</p> 	<p>CDR.0092 Safety relief valve VS 220, 220 bar-3200 psi, 24 l/min 6.30 USGpm, 90 °C-195 °F, inlet 2xG 3/8" F</p> 
gr. 55 oz. 2.0 hose-barb ø 16 mm-0,63"	gr. 55 oz. 2.0 hose-barb ø 16 mm-0,63"	gr. 135 oz. 4.8 Inlet G 1/4" M By-pass G 1/8" F	gr. 410 oz. 14.5 By-pass G 3/8" F
<p>CDR.0423 Safety relief valve VS 500 500 bar 7250 psi, 800 l/min 21.00 USGpm, 90 °C-195 °F</p> 	<p>CDR.0387 Safety relief valve VS 350, 350 bar 5100 psi, 25 l/min 6.60 USGpm, 90 °C-195 °F</p> 	<p>CDR.0386 Safety relief valve VS 200/180, 180/200 bar 2600/2900 psi, 200 l/min 52.80 USGpm, 90 °C-195 °F</p> 	<p>CDR.0891 Safety relief valve MG 3000, 250 bar 3650 psi, 40 l/min 10.50 USGpm, 90 °C-195 °F</p> 
gr. 1450 oz. 51.2 Inlet G 1/2" F By-pass G 3/8" F	gr. 480 oz. 17.0 Inlet G 3/8" F-F By-pass G 3/8" F-F	gr. 820 oz. 29.0 Inlet G 3/4" F By-pass G 1/2" F	gr. 500 oz. 17.5 Inlet G 3/8" F By-pass G 1/4" F



**Motor-pump
- Inlet water filters**

The spare parts branded "CdR" exclusively refer to products by Club dei Riparatori® by IDROBASE®

<p>CDR.7262 Inlet water filter Small - 5", with transparent plastic glass, brass connections G 1/2" F-F</p>  <p>gr. 450 oz. 15.9</p> <p><i>Complete with spanner</i></p>	<p>CDR.7263 Inlet water filter Medium - 7", with transparent plastic glass, brass connections G 3/4" F-F</p>  <p>gr. 950 oz. 33.6</p> <p><i>Complete with spanner and fixing bracket</i></p>	<p>CDR.7258 Inlet water filter Big - 10", with transparent plastic glass, brass connections G 3/4" F-F</p>  <p>gr. 1090 oz. 38.5</p> <p><i>Complete with spanner and fixing bracket</i></p>	<p>CDR.7265 Inlet water filter Extra - 20", with blue plastic glass, plastic connections G 1" F-F</p>  <p>gr. 1850 oz. 65.3</p>
<p>BL.024072 Connection filter nipple, 40 bar-580 psi, G 3/4" M-M</p>  <p>gr. 86 oz. 3.1</p>	<p>CDR.7268 Fixing bracket, for filter Medium - 7" and Big - 10"</p>  <p>gr. 70 oz. 2.5</p>	<p>CDR.7175 "Y" inlet water filter, made of brass, inlet G 1/2" F, outlet G 1/2" F</p>  <p>gr. 150 oz. 5.3</p>	<p>CDR.7176 "Y" inlet water filter, made of brass, inlet G 3/4" F, outlet G 3/4" F</p>  <p>gr. 230 oz. 8.2</p>
<p>CDR.7253 Polypropylene thread filter cartridge, 5 microns, for filter Small - 5" (code CDR.7262)</p>  <p>gr. 75 oz. 2.7</p>	<p>CDR.7264 Carbon filter cartridge, 5 microns, for filter Medium - 7" (code CDR.7263)</p>  <p>gr. 310 oz. 11.0</p>	<p>CDR.7261 Resin filter cartridge, for filter Big - 10" (code CDR.7258)</p>  <p>gr. 415 oz. 14.7</p>	
<p>CDR.7255 Polypropylene thread filter cartridge, 5 microns, for filter Big - 10" (code CDR.7258)</p>  <p>gr. 210 oz. 7.5</p>	<p>CDR.7260 Polypropylene thread filter cartridge, 1 micron, for filter Big - 10" (code CDR.7258)</p>  <p>gr. 220 oz. 7.8</p>	<p>CDR.7266 Polypropylene thread filter cartridge, 5 microns, for filter Extra - 20" (code CDR.7265)</p>  <p>gr. 395 oz. 14.0</p>	<p>CDR.7267 Polypropylene thread filter cartridge, 1 micron, for filter Extra - 20" (code CDR.7265)</p>  <p>gr. 440 oz. 15.6</p>

Motor-pump - Inlet water filters

CDR.0725

Inlet water filter,
transparent G 1/2" F-F,
max pressure
10 bar-145 psi,
filtering capacity
55 l/min-14.50 USGpm
at 0,5 bar-7.00 psi.
fiberglass-reinforced
polypropylene body, transparent
nylon glass, EPDM gasket



gr. 120 Complete with stainless steel cartridge
oz. 4.3 (blue colour) filtering element 50 mesh

CDR.0727

Inlet water filter,
black G 1/2" F-F,
max pressure
14 bar-200 psi,
filtering capacity
80-100 l/min-21-26 USGpm.
fiberglass-reinforced
polypropylene body
and glass, EPDM gasket



gr. 180 Complete with stainless steel cartridge
oz. 6.4 (blue colour) filtering element 50 mesh

Filter cartridge in SS ø27x69

Code	Colour / Filtering	Weight
CDR.0731	White	gr. 5
	32 mesh	oz. 0.2
CDR.0732	Blue	gr. 5
	50 mesh	oz. 0.2
CDR.0733	Grey	gr. 5
	80 mesh	oz. 0.2
CDR.0734	Red	gr. 5
	100 mesh	oz. 0.2

CDR.0729

Inlet water filter,
black G 3/4" F-F,
max pressure
14 bar-200 psi,
filtering capacity
80-100 l/min-21-26 USGpm.
fiberglass-reinforced
polypropylene body
and glass, EPDM gasket



gr. 170 Complete with stainless steel cartridge
oz. 6.0 (blue colour) filtering element 50 mesh

CDR.0730

Inlet water filter,
black G 3/4" F-F,
max pressure
14 bar-200 psi,
filtering capacity
80-100 l/min-21-26 USGpm.
fiberglass-reinforced
polypropylene body
and glass, EPDM gasket



gr. 170 Complete with stainless steel cartridge
oz. 6.0 (red colour) filtering element 100 mesh

Filter cartridge in SS ø38x89

Code	Colour / Filtering	Weight
CDR.0735	White	gr. 15
	32 mesh	oz. 0.6
CDR.0736	Blue	gr. 15
	50 mesh	oz. 0.6
CDR.0737	Grey	gr. 15
	80 mesh	oz. 0.6
CDR.0738	Red	gr. 15
	100 mesh	oz. 0.6

ZX.0833

Straight hose-barb
G 1/2" M-ø13 mm-0.51",
made of polypropylene



gr. 10 Complete with O-Ring
oz. 0.4

ZX.0834

Straight hose-barb
G 1/2" M-ø16 mm-0.63",
made of polypropylene



gr. 10 Complete with O-Ring
oz. 0.4

ZX.0837

Straight hose-barb
G 1/2" M-ø20 mm-0.79",
made of polypropylene



gr. 10 Complete with O-Ring
oz. 0.4

ZX.0835

Straight hose-barb
G 3/4" M-ø16 mm 0.63",
made of polypropylene



gr. 15 Complete with O-Ring
oz. 0.6

ZX.0836

Straight hose-barb
G 3/4" M-ø20 mm-0.79",
made of polypropylene



gr. 15 Complete with O-Ring
oz. 0.6



White cartridge 32 mesh Blue cartridge 50 mesh Grey cartridge 80 mesh Red cartridge 100 mesh

ZX.7029

Inlet water fitting Kärcher,
(for PROFESSIONAL H.P. WASHERS)
transparent glass,
inlet G 1" M,
outlet G 1" F,
max pressure
10 bar



gr. 290 Complete of stainless steel cartridge
oz. 10.2 100 mesh

New

ZX.7028

Hose-barb complete with O-ring,
made of plastic
for inlet water filter fitting Kärcher
(code ZX.7029),
inlet G 1" F



gr. 20
oz. 0.7

CDR.1239-Y

Inlet water fitting Kärcher,
(for HOBBY and SEMI-PROFESSIONAL
H.P. WASHERS)
transparent glass,
inlet G 3/4" F,
outlet G 3/4" M,
max pressure 8 bar,
80 microns











gr. 95 Complete of cartridge
oz. 3.4 250 mesh

New





Unloader valves

- By-pass: medium pressure

<p>CDR.0456</p> <p>VB 130, 160 bar-2300 psi, 25 l/min-6.5 USGpm, 90 °C-195 °F inlet G 3/8" M, outlet G 3/8" M</p>  <p>gr. 390 oz. 13.8</p> <p>By-pass G 3/8" F</p>	<p>P.60.0700.00</p> <p>VB 7, 220 bar-3200 psi, 30 l/min-8 USGpm, 90 °C-195 °F, inlet G 3/8" M, outlet G 3/8" F</p>  <p>gr. 590 oz. 20.9</p> <p>By-pass G 3/8" F</p>	<p>MV.215002000</p> <p>MV 550, 250 bar-3650 psi, 30 l/min-8 USGpm, 90 °C-195 °F, inlet G 3/8" F, outlet G 3/8" F</p>  <p>gr. 710 oz. 25.1</p> <p>By-pass 2 x G 1/4" F</p>	<p>P.60.0006.60</p> <p>Pulsar 3, 220 bar-3200 psi, 30 l/min-8 USGpm, 90 °C-195 °F, inlet G 3/8" F, outlet G 3/8" F</p>  <p>gr. 780 oz. 27.6</p> <p>By-pass 2 x G 3/8" F</p>	
<p>P.60.2250.00</p> <p>VB 9, 200 bar-2900 psi, 30 l/min-8 USGpm, 90 °C-195 °F, inlet G 3/8" F, outlet G 3/8" F</p>  <p>gr. 770 oz. 27.2</p> <p>By-pass G 3/8" F</p>	<p>CDR.0840</p> <p>VB 10, 220 bar-3200 psi, 30 l/min-8 USGpm, 90 °C-195 °F, inlet G 3/8" F, outlet G 3/8" F</p>  <p>gr. 1100 oz. 38.9</p> <p>By-pass G 3/8" F</p>	<p>CDR.0378</p> <p>ST-261, 250 bar-3650 psi, 30 l/min-8 USGpm, 80 °C-175 °F, inlet G 3/8" F, outlet G 1/2" F</p>  <p>gr. 630 oz. 22.3</p> <p>By-pass G 1/4" F</p>	<p>I.K3.1</p> <p>K3.1, 100 bar-1450 psi, 11÷16 l/min 2.90÷4.22 USGpm, inlet G 3/8" F, outlet G 1/2" F</p>  <p>gr. 760 oz. 26.9</p> <p>By-pass G 3/4" MG 1/4" F</p>	<p>I.K5.1</p> <p>K5.1, 200 bar-2900 psi, 11÷16 l/min, 2.90÷4.22 USGpm, inlet G 3/8" F, outlet G 1/2" F</p>  <p>gr. 1060 oz. 37.5</p> <p>By-pass G 3/4" M-G 1/4" F</p>



Unloader valves

- By-pass + switch: medium pressure

<p>MV.215002040</p> <p>MV 550 + micro-switch, 250 bar-3650 psi, 30 l/min-8 USGpm, 90 °C-195 °F, inlet G 3/8" F, outlet G 3/8" F</p>  <p>gr. 875 oz. 30.9</p> <p>By-pass 2 x G 1/4" F</p>	<p>P.60.0010.62</p> <p>Pulsar 3 + micro-switch, 220 bar-3200 psi, 30 l/min-8 USGpm, 90 °C-195 °F, inlet G 3/8" F, outlet G 3/8" F</p>  <p>gr. 900 oz. 31.8</p> <p>By-pass 2 x G 3/8" F</p>	<p>P.60.2350.00</p> <p>VB 9 + micro-switch, 200 bar-2900 psi, 30 l/min-8 USGpm, 90 °C-195 °F, inlet G 3/8" F, outlet G 3/8" F</p>  <p>gr. 1000 oz. 35.3</p> <p>By-pass G 3/8" F</p>	<p>CDR.0376</p> <p>ST-261 + micro-switch, 250 bar-3650 psi, 30 l/min-8 USGpm, 80 °C-175 °F, inlet G 3/8" F, outlet G 1/2" F</p>  <p>gr. 850 oz. 30.0</p> <p>By-pass G 1/4" F</p>
---	---	---	---

Unloader valves

- By-pass: high pressure

<p>CDR.0374</p> <p>VB 80/280, 280 bar-4050 psi, 80 l/min-21 USGpm, 90 °C-195 °F, inlet G 1/2" F, outlet G 1/2" F</p>  <p>gr. 1270 oz. 44.9</p> <p>By-pass G 1/2" F</p>	<p>CDR.0375</p> <p>VB 350, 350 bar-5100 psi, 40 l/min-10.50 USGpm, 90 °C-195 °F, inlet G 3/8" M, outlet G 3/8" F</p>  <p>gr. 880 oz. 31.1</p> <p>By-pass G 1/2" F</p>	<p>CDR.0422</p> <p>VB 16, 500 bar-7250 psi, 80 l/min-21 USGpm, 90 °C-195 °F, inlet G 1/2" F, outlet G 1/2" F 110 bar-1600 psi is the minimum pressure at the by-pass restart. 190 bar-2750 psi is the residual pressure when the circuit closes.</p>  <p>gr. 3450 oz. 121.8</p> <p>By-pass G 1/2" F</p>
---	---	--

Unloader valves

- *By-pass: service kit*

<p>CDR.0839</p> <p>Service kit VB 130-VB 135 (code CDR.0456-P.60.0765.00-P.60.0930.00)</p>  <p>gr. 25 oz. 0.9</p> <p>quantity 11x1</p>	<p>ZX.0838</p> <p>Service kit VB 7-VB 75 (code P.60.0700.00-P.60.0765.00-P.60.0930.00)</p>  <p>gr. 20 oz. 0.8</p> <p>quantity 9x1</p>	<p>ZX.0633</p> <p>Service kit MV 550 (code MV.215002000)</p>  <p>gr. 30 oz. 1.1</p> <p>quantity 16x1</p>	<p>CDR.0830</p> <p>Service kit Pulsar 3 (code P.60.0006.60)</p>  <p>gr. 20 oz. 0.7</p> <p>quantity 11x1</p>
<p>CDR.0834</p> <p>Service kit VB 9 (code P.60.2250.00)</p>  <p>gr. 20 oz. 0.8</p> <p>quantity 9x1</p>	<p>CDR.0835</p> <p>Service kit VB 10 (code CDR.0840)</p>  <p>gr. 95 oz. 3.4</p> <p>quantity 15x1</p>	<p>CDR.0418</p> <p>Service kit ST-261 (code CDR.0378)</p>  <p>gr. 15 oz. 0.6</p> <p>quantity 4x1</p>	<p>CDR.0453</p> <p>Piston service kit ST-261 (code CDR.0378)</p>  <p>gr. 90 oz. 3.2</p> <p>quantity 2x1</p>
<p>I.KIT-59</p> <p>Service kit K3.1 (code I.K3.1)</p>  <p>gr. 70 oz. 2.5</p> <p>quantity 16x1</p>	<p>I.KIT-58</p> <p>Service kit K5.1 (code I.K5.1)</p>  <p>gr. 100 oz. 3.6</p> <p>quantity 16x1</p>	<p>CDR.0836</p> <p>Service kit MV 550 + microswitch (code MV.215002040)</p>  <p>gr. 25 oz. 0.9</p> <p>quantity 18x1</p>	<p>CDR.0837</p> <p>Service kit Pulsar 3 + microswitch (code P.60.0010.62)</p>  <p>gr. 25 oz. 0.9</p> <p>quantity 16x1</p>
<p>CDR.0831</p> <p>Service kit VB 9 + microswitch (code P.60.2350.00)</p>  <p>gr. 15 oz. 0.6</p> <p>quantity 17x1</p>	<p>CDR.0419</p> <p>Service kit ST-261 + microswitch (code CDR.0376)</p>  <p>gr. 60 oz. 2.2</p> <p>quantity 1</p>	<p>CDR.0838</p> <p>Service kit VB 80/280 (code CDR.0374)</p>  <p>gr. 20 oz. 0.8</p> <p>quantity 9x1</p>	<p>CDR.0832</p> <p>Service kit VB 350 (code CDR.0375)</p>  <p>gr. 95 oz. 3.4</p> <p>quantity 12x1</p>

Unloader valves

- *Integrated: service kit*

<p>CDR.0466</p> <p>Service kit VB 55 (codes CDR.0025, CDR.0027, CDR.0028, P.60.1375.00)</p>  <p>gr. 20 oz. 0.7</p> <p>quantity 10x1</p>	<p>ZX.0838</p> <p>Service kit VB 7-VB 75 (codes P.60.0700.00, P.60.0765.00, P.60.0930.00)</p>  <p>gr. 20 oz. 0.7</p> <p>quantity 9x1</p>	<p>CDR.0839</p> <p>Service kit VB 130-VB 135 (codes CDR.0456, P.60.0765.00, P.60.0930.00)</p>  <p>gr. 25 oz. 0.9</p> <p>quantity 11x1</p>
---	--	---

Club dei Riparatori®

**The winning solution to manufacture
and repair all kinds of pressure washers**



ZX.0082
Kit Dolly C1 couple of electrodes, for heaters of h.p. washers fitting *Cristanini*

gr. 50
oz. 1.8

to obtain inches multiply for 0.0394

ZX.0225
Kit Dolly Com1 couple of electrodes, for heaters of h.p. washers fitting *Comet*

gr. 55
oz. 2.0

to obtain inches multiply for 0.0394

ZX.0107
Kit Dolly F1 couple of electrodes, for heaters of h.p. washers fitting *Faip TK and Indy*

gr. 70
oz. 2.5

to obtain inches multiply for 0.0394

ZX.0108
Kit Dolly F2 couple of electrodes, for heaters of h.p. washers fitting *Faip American fire*

gr. 70
oz. 2.5

to obtain inches multiply for 0.0394

TX.0003
Kit Dolly IB1 double electrode, for heaters of h.p. washers fitting *Idromatic*

gr. 40
oz. 1.5

to obtain inches multiply for 0.0394

TX.0011
Kit Dolly IB2 double electrode, for heaters of h.p. washers fitting *Idromatic, Castello, Fasa and B&C*

gr. 45
oz. 1.6

to obtain inches multiply for 0.0394

ZX.0598
Kit Dolly IT2 couple of electrodes, for heaters of h.p. washers fitting *ITM*

gr. 65
oz. 2.3

to obtain inches multiply for 0.0394

ZX.0596
Kit Dolly L4 couple of electrodes, for heaters of h.p. washers fitting *Lavor*

gr. 65
oz. 2.3

to obtain inches multiply for 0.0394

ZX.0468
Kit Dolly L6 double electrode, for heaters of h.p. washers fitting *Lavor FXK and Paraná*

gr. 60
oz. 2.2

to obtain inches multiply for 0.0394

ZX.0599
Kit Dolly KW1 couple of electrodes, for heaters of h.p. washers fitting *Kew: 0802V/VA, 1502V/VA, 2602V/VA, 16A2V/VA, 23A2V/VA, 26A2V/VA, 3842V/VA and Contractor Master*

gr. 105
oz. 3.7

to obtain inches multiply for 0.0394

ZX.0600
Kit Dolly KW2 couple of electrodes for heaters of h.p. washers fitting *Kew: 4203V/VA, 5003V/VA and Contractor Diesel Heavy Duty*

gr. 110
oz. 3.9

to obtain inches multiply for 0.0394

ZX.0109
Kit Dolly P1 couple of electrodes, for heaters of h.p. washers fitting *Portotecnica: Argon, Solar, Mitho, Universe, Kosmic Maxi Jet and Silver Jet*

gr. 60
oz. 2.2

to obtain inches multiply for 0.0394

ZX.0143
Kit Dolly P3 double electrode, for heaters of h.p. washers fitting *Portotecnica: Futura, Mistral Jet profy, Golden Jet, Synchron and Skid Fuego*

gr. 75
oz. 2.7

to obtain inches multiply for 0.0394

ZX.0007
Kit Dolly Pulit1 double electrode, for heaters of h.p. washers fitting *Pulitecno*

gr. 60
oz. 2.2

to obtain inches multiply for 0.0394

ZX.0606
Kit Dolly S2 couple of electrodes, for heaters of h.p. washers fitting *Sirio*

gr. 90
oz. 3.2

to obtain inches multiply for 0.0394

ZX.0597
Kit Dolly SI2 couple of electrodes, for heaters of h.p. washers fitting *Sial*

gr. 70
oz. 2.5

to obtain inches multiply for 0.0394

ZX.0601
Kit Dolly WP1 couple of electrodes, for heaters of h.p. washers fitting *WAP - ø8x100mm-0.24"x3.94"*

gr. 100
oz. 3.6

to obtain inches multiply for 0.0394

ZX.0602
Kit Dolly WP2 couple of electrodes, for heaters of h.p. washers fitting *WAP - ø6x75mm-0.24"x2.96"*

gr. 40
oz. 1.5

to obtain inches multiply for 0.0394

ZX.0118

Kit Dolly X1 couple of electrodes for heaters of h.p. washers fitting
Kärcher: HDS 550 - HDS 610 - HDS 650 - HDS 755 - HDS 760 -
HDS 850 - HDS 890 -
HDS 990 - HDS 1000 BE -
HDS 1000 DE - HDS 1200 BE -
HDS 1200 DE - HDS 1210 -
HDS 1250 - HDS 1250 N -
HDS 1290 - HDS 1290 ST

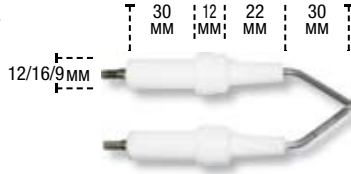

gr. 85
oz. 3.0

to obtain inches multiply for
0.0394

ZX.0605

Kit Dolly X2 double electrode for heaters of h.p. washers fitting
Kärcher: KK 855 H - K 855 H PLUS - HDS 400 C - HDS 551 C -
HDS 555 CI - HDS 558 C - HDS 600 C SICIAL - HDS 600 CI -
HDS 601 C - HDS 695 - HDS 697 CI -
HDS 698 C - HDS 699 - HDS 790 CI -
HDS 795 - HDS 797 CI -
HDS 798 C - HDS 801 B -
HDS 895 - HDS 895 SPECIAL -
HDS 1195 - HDS 1295 -
1500 SUPER - 2700 SUPER

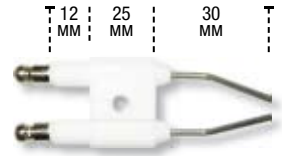

gr. 80
oz. 2.9

to obtain inches multiply for
0.0394

EE.26-198

Spark plug fitting Kärcher for Kit Dolly X2
(code ZX.0605)



gr. 110
oz. 3.9

MC.10.00623

Spark plug
ø6.25 red,
with suppressor 1000 Ohm



gr. 17
oz. 0.6

MC.12.00590

Spark plug
ø6.25 blue,
without suppressor



gr. 11
oz. 0.4

Heating system
- Pressure switches

P.29.0080.18

Pressure switch PR5
G 1/8" M, 25 bar-360 psi,
90 °C-195 °F, 6 A, 250 V,
3 cables, insulation class IP55
max pressure 280 bar-4050 psi



gr. 130
oz. 4.6

electric cable length,
1000 mm-39.40"

P.29.0080.55

Pressure switch PR5
G 1/8" M, 40 bar-580 psi,
90 °C-195 °F, 6 A, 250 V,
3 cables, insulation class IP55
max pressure 280 bar-4050 psi



gr. 130
oz. 4.6

electric cable length,
1000 mm-39.40"

P.29.0080.00

Pressure switch PR5
G 1/4" M, 25 bar-360 psi,
90 °C-195 °F, 6 A, 250 V,
3 cables, insulation class IP55
max pressure 280 bar-4050 psi



gr. 130
oz. 4.6

electric cable length,
1000 mm-39.40"

P.29.0080.50

Pressure switch PR5
G 1/4" M, 40 bar-580 psi,
90 °C-195 °F, 6 A, 250 V,
3 cables, insulation class IP55
max pressure 280 bar-4050 psi



gr. 130
oz. 4.6

electric cable length,
1000 mm-39.40"

P.29.0040.30

Pressure switch PR16
G 1/4" M, 25 bar-360 psi,
75 °C-165 °F, 16 A, 250 V,
3 cables, insulation class IP55
max pressure 280 bar-4050 psi



gr. 260
oz. 9.2

electric cable length,
1200 mm-47.30"

P.29.0040.20











Pressure switch PR16
G 1/4" M, 40 bar-580 psi,
75 °C-165 °F, 16 A, 250 V,
3 cables, insulation class IP55
max pressure 280 bar-4050 psi









gr. 260
oz. 9.2

electric cable length,
1200 mm-47.30"

Heating system - Ignition Transformers



<p>SC.2815 Professional ignition transformer Scaldalai, 2x4000 V, 18 mA, 1x230 V-50 Hz</p>  <p>gr. 1900 oz. 74.9</p> <p><i>Single-phase</i></p>	<p>SC.2815/110 Professional ignition transformer Scaldalai, 2x4000 V, 18 mA, 1x110/115 V-50 Hz</p>  <p>gr. 1900 oz. 74.9</p>	<p>SC.2815/380 Professional ignition transformer Scaldalai, 2x4000 V, 18 mA, 3x400 V-50 Hz</p>  <p>gr. 1900 oz. 74.9</p> <p><i>Three-phase</i></p>	
<p>COF.TRS812C Professional ignition transformer Cofi, 2x4000 V, 12 mA, 1x230 V-50 Hz, without electric cable</p>  <p>gr. 1920 oz. 75.7</p> <p><i>Fitting Portotecnica. Single-phase</i></p>	<p>COF.TR818C Professional ignition transformer Cofi, 2x4000 V, 18 mA, 1x230 V-50 Hz</p>  <p>gr. 1950 oz. 76.9</p> <p><i>Single-phase</i></p>	<p>COF.TRG1020C Professional ignition transformer Cofi, 2x5000 V, 20 mA, 1x230 V-50 Hz</p>  <p>gr. 2800 oz. 110.4</p> <p><i>Single-phase</i></p>	<p>COF.TRG1020C3 Professional ignition transformer Cofi, 2x5000 V, 20 mA, 3x400 V-50 Hz</p>  <p>gr. 2800 oz. 110.4</p> <p><i>Three-phase</i></p>
<p>ZX.0091 Professional ignition transformer Cofi, 2x5000 V, 20 mA, 1x230 V-50 Hz, with fixing bracket</p>  <p>gr. 2800 oz. 110.4</p> <p><i>Fitting Kärcher. Single-phase</i></p>	<p>ZX.0092 Professional ignition transformer Cofi, 2x5000 V, 20 mA, 3x400 V-50 Hz, with fixing bracket</p>  <p>gr. 2800 oz. 110.4</p> <p><i>Fitting Kärcher. Three-phase</i></p>	<p>ZX.0461 Electronic ignition transformer Cofi, 2x12 KV, 30 mA, 1x230 V-50/60 Hz, complete with electric cable</p>  <p>gr. 350 oz. 13.8</p> <p><i>Single-phase</i></p>	

Heating system - Ignition Transformers: accessories

<p>SC.0001 High tension silicon cable, $\varnothing 7$ mm suitable for any ignition transformers</p>  <p>gr. 65 oz. 2.6</p> <p><i>Price is per metre</i></p>	<p>COF.0003 High tension cable, 750 mm-29.60", complete with red spark plug</p>  <p>gr. 60 oz. 2.4</p> <p><i>For ignition transformers codes: ZX.0461 and COF.TRS812C</i></p>	<p>TX.0006 Couples of high tension cables, 950 mm-37.50", made of carbon fiber $\varnothing 7$ mm-0.28" Fully sheilded and wired with connectors: $\varnothing 6,3$ mm-0.25" (connection to the spark plugs) $\varnothing 4$ mm-0.16" (connection to the ignition transformer)</p>  <p>gr. 110 oz. 4.4</p>	
<p>COF.SPINA-T Electric cable 800 mm-31.50", with plug joint, for ignition transformer fitting Portotecnica (code COF.TRS812C)</p>  <p>gr. 45 oz. 1.8</p>	<p>ZX.0622 Connectors set $\varnothing 6,3$ mm-0.25", for high tension cable. To connect high tension cable to the ignition transformer</p>  <p>gr. 60 oz. 2.4</p> <p><i>(20 pcs each set)</i></p>	<p>ZX.0648 Connectors set $\varnothing 4$ mm-0.16", for high tension cable. To connect high tension cable to the electrodes</p>  <p>gr. 50 oz. 2.0</p> <p><i>(20 pcs each set)</i></p>	<p>COF.172601 Silicon protection, for high tension cable</p>  <p>gr. 3 oz. 0.2</p>









Heating system - Fuel nozzles

Danfoss fuel nozzles 60 °S		Danfoss fuel nozzles 60 °H		Conversion table Fuel nozzles	
Code	gl/h	Code	gl/h		
DA.030F6908	0.50	DA.030H6908	0.50	Delavan A	→ Danfoss H
DA.030F6912	0.60	DA.030H6912	0.60	Delavan B	→ Danfoss S
DA.030F6914	0.65	DA.030H6914	0.65	Fluidics SF	→ Danfoss S
DA.030F6916	0.75	DA.030H6916	0.75	Fluidics HF	→ Danfoss H
DA.030F6918	0.85	DA.030H6918	0.85	Fluidics S	→ Danfoss S
DA.030F6920	1.00	DA.030H6920	1.00	Fluidics H	→ Danfoss H
DA.030F6922	1.10	DA.030H6922	1.10	Monarch PL	→ Danfoss H
DA.030F6924	1.25	DA.030H6924	1.25	Monarch NS	→ Danfoss H
DA.030F6926	1.35	DA.030H6926	1.35	Monarch AR	→ Danfoss S
DA.030F6928	1.50	DA.030H6928	1.50	Monarch R	→ Danfoss S
DA.030F6929	1.65	DA.030H6929	1.65	Hago B	→ Danfoss S
DA.030F6930	1.75	DA.030H6930	1.75	Hago H	→ Danfoss H
DA.030F6132	2.00	DA.030H6132	2.00	Hago SS	→ Danfoss H
DA.030F6134	2.25	DA.030H6134	2.25	Hago P	→ Danfoss S
DA.030F6138	2.75	DA.030H6138	2.75	Hago ES	→ Danfoss S
				Steinen PH	→ Danfoss H
				Steinen H	→ Danfoss H
				Steinen Q	→ Danfoss S
				Steinen S	→ Danfoss S

		
gr. 27 oz. 1.0	gr. 27 oz. 1.0	

*Above data are only for indicative use
Give us a call for different nozzles required*

Heating system - Fuel filters

CDR.7004 In line fuel filter 43 microns 	CDR.7060 In line fuel filter 152 microns 	CDR.7005 In line fuel filter 300 microns 	CDR.7059 In line fuel filter 250 microns 	CDR.0551 Fuel hose ø7x12 mm-0.27"x0.47" 
gr. 11 oz. 0.4	gr. 11 oz. 0.4	gr. 30 oz. 1.1	gr. 30 oz. 1.1	gr. 120 oz. 4.3 <i>Price per metre</i>
CDR.0430 Aluminium fuel filter G 3/8" F-F, with water cleaning out device 	FG.20101/PL Aluminium fuel filter G 3/8" F-F, 	FG.SET20100 Set O-Rings for aluminium fuel filter (code FG.20101/PL) 	FG.20101/C1 Filter element for aluminium fuel filter (code FG.20101/PL) 	
gr. 240 oz. 8.5	gr. 125 oz. 4.5	gr. 7 oz. 0.3	gr. 20 oz. 0.8	

Heating system

- Fuel pumps

The spare parts branded "CDR®" exclusively refer to products by Club dei Riparatori® by IDROBASE®

2 Pipes without solenoid valve



Code	Rotation seen from pump shaft	Inlet nozzle seen from cover side	Weight
ED.VD1RL2	Clockwise	Left	gr. 950 oz. 33.6
ED.VD1RR2	Clockwise	Right	gr. 950 oz. 33.6
ED.VD1LL2	Anticlockwise	Left	gr. 950 oz. 33.6
ED.VD1LR2	Anticlockwise	Right	gr. 950 oz. 33.6

2 Pipes with solenoid valve



Code	Rotation seen from pump shaft	Inlet nozzle seen from cover side	Weight
ED.VM1RL2*	Clockwise	Left	gr. 990 oz. 35.0
ED.VM1RR24*	Clockwise	Right	gr. 990 oz. 35.0
ED.VM1LL2*	Anticlockwise	Left	gr. 990 oz. 35.0
ED.VM1LR24*	Anticlockwise	Right	gr. 990 oz. 35.0

ED.BOM220AC
Electric coil 240 V complete with: coil with cable, plate and fixing ring

gr. 110
oz. 3.9

Electric cable 700 mm-27.6"

ED.BOM024AC
Electric coil 24 V complete with: coil with cable, plate and fixing ring

gr. 110
oz. 3.9

Electric cable 700 mm-27.6"

ZX.0106
Set O-Ring + filter

gr. 10
oz. 0.4

ZX.0679
Set O-Ring + filter NEW VERSION (body thickness 46 mm instead of 54 mm)

gr. 10
oz. 0.4

ED.0012
Electric cable 700 mm, for all the electric coils with plug joint

gr. 55
oz. 2.0

Plug joint

ED.0010
Electric coil 230 V complete with: plate and fixing ring

gr. 80
oz. 2.9

Plug joint

ED.0011
Electric coil 24 V complete with: plate and fixing ring

gr. 80
oz. 2.9

Plug joint

ED.0013
Electric coil 110 V complete with: plate and fixing ring

gr. 80
oz. 2.9

Plug joint

Universal

ED.0003
Universal fuel pump lets you replace all fuel pumps with clockwise and anticlockwise rotation, right or left inlet nozzle pipe, one or two pipes with only one fuel pump, effortlessly and with no special tools. It is complete with: coil 230 V, 700 mm electric cable and cap to transform it from 2 to 1 pipe.

gr. 1240
oz. 43.8

2 pipes aluminium + solenoid valve

Code	Rotation seen from pump shaft	Inlet nozzle	Weight
CDR.0087	Clockwise	Left and / or Right	gr. 660 oz. 23.0
CDR.0088	Anticlockwise	Left and / or Right	gr. 660 oz. 23.0

2 pipes aluminium without solenoid valve

Code	Rotation seen from pump shaft	Inlet nozzle	Weight
CDR.0087-SE	Clockwise	Left and / or Right	gr. 600 oz. 21.0
CDR.0088-SE	Anticlockwise	Left and / or Right	gr. 600 oz. 21.0

CDR.0089
Electric coil 230 V, for aluminium and universal fuel pumps, complete with: plate and fixing ring

gr. 80
oz. 2.9

Plug joint

CDR.0090
Electric coil 24 V, for aluminium and universal fuel pumps, complete with: plate and fixing ring

gr. 80
oz. 2.9

Plug joint

CDR.0091
Electric coil 110 V, for aluminium and universal fuel pumps, complete with: plate and fixing ring

gr. 80
oz. 2.9

Plug joint

ED.0012
Electric cable 700 mm, for all the electric coils with plug joint

gr. 55
oz. 2.0

Plug joint

ZX.0022
Kit cartridge + filter for aluminium fuel pumps

gr. 8
oz. 0.3

Heating system

- Fuel pumps: spare parts

ED.0001
Solenoid valve with coil
230 V, for fuel pumps,
 inlet
 G 1/8" M,
 outlet
 G 1/8" F



gr. 200
oz. 7,1

With cable
700 mm-27.6"

ED.0002
Solenoid valve with coil
24 V, for fuel pumps,
 inlet
 G 1/8" M,
 outlet
 G 1/8" F



gr. 200
oz. 7,1

With cable
700 mm-27.6"

ONE PIPE FUEL PUMPS

Will be supplied only:

- On request
- Minimum 20 pcs per model
- Delivery: 20 days

Heating system

- Fuel pumps fitting Kärcher and WAP

The spare parts branded "CdR" exclusively refer to products by Club dei Riparatori® by IDROBASE®

2 Pipes without solenoid valve



Fuel pumps without solenoid valve fitting WAP, clock or anticlockwise rotation seen from fuel pump shaft.

Code	Rotation seen from pump shaft	Weight
CDR.0705	Clockwise	gr. 750 oz. 26.5
CDR.0704	Anticlockwise	gr. 750 oz. 26.5

2 Pipes with solenoid valve



Fuel pumps with solenoid valve fitting Kärcher, with 500 mm electric cable, clock or anticlockwise rotation seen from fuel pump shaft.

Code	Rotation seen from pump shaft	Volts	Weight
CDR.0703	Clockwise	230 V	gr. 850 oz. 30.0
CDR.0702	Clockwise	24 V	gr. 850 oz. 30.0
CDR.0701	Anticlockwise	230 V	gr. 850 oz. 30.0
CDR.0700	Anticlockwise	24 V	gr. 850 oz. 30.0

CDR.0707
Electric coil 230 V,



gr. 100
oz. 3.6

With cable
500 mm-17.7"

CDR.0706
Electric coil 24 V,



gr. 100
oz. 3.6

With cable
500 mm-17.7"

CDR.0708
Filter cartridge



gr. 7
oz. 0.3

CDR.0709
O-Ring



gr. 2
oz. 0.1

CDR.0710
Diaphragm



gr. 5
oz. 0.2

Heating system

- Electric fuel pumps

Electric fuel pumps 230V, suitable for hot high pressure washers hobby and semi-professionals, fitting: Comet, Lavor, Kärcher e Portotecnica

CDR.0688
Electric fuel pump VSC36
self-aspiring,
 230 V-50/60 Hz,
 14 l/h-3.7 USGph,
 inlet G 1/4" F,
 outlet G 1/8" M



gr. 650
oz. 23.0

Size fuel nozzle:
0.60-0.70

CDR.0689
Electric fuel pump VSC36
self-aspiring,
 230 V-50/60 Hz,
 15,5 l/h-4.1 USGph,
 inlet G 1/4" F,
 outlet G 1/8" M



gr. 650
oz. 23.0

Size fuel nozzle:
0.75-1.50

CDR.0502
Electric fuel pump,
 230 V-50 Hz, 15 bar-215 psi, 600 cc/min,
 inlet \varnothing 7,5 mm-0.3",
 outlet \varnothing 14 mm-0.55"
 / G 1/8" M



gr. 470
oz. 16.6

Inlet and outlet with plastic hose-barb and O-Ring of VITON

CDR.0661

CdR S15 coil, for high pressure washers fitting **Alberti**

Series:

- EASY
- MEDI-JET
- MICRO-JET



gr. 16400
oz. 579.0

Made of electric welded steel pipe, hot rolled $\varnothing 17$ mm-0.67"

CDR.0663

CdR S17 coil, for high pressure washers fitting **Alberti**

Series:

- COMPACT



gr. 22700
oz. 801.4

Made of electric welded steel pipe, hot rolled $\varnothing 17$ mm-0.67"

CDR.0662

CdR S16 coil, for high pressure washers fitting **Alberti**

Series:

- STARJET
- SUPERLUX

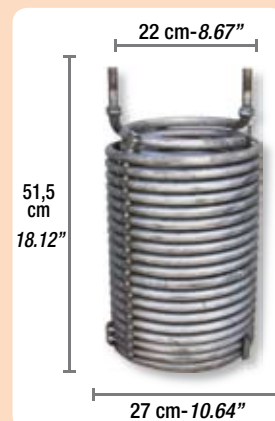

gr. 27000
oz. 953.1

Made of electric welded steel pipe, hot rolled $\varnothing 17$ mm-0.67"

CDR.0664

CdR S18 coil, for high pressure washers fitting **Comet**

Series:

- SCOUT



gr. 15800
oz. 557.8

Made of electric welded steel pipe, hot rolled $\varnothing 17$ mm-0.67"

CDR.0521

CdR S10 coil, for high pressure washers fitting **Comet**

Series:

- FD RANGER
- FD RANGER PLUS



gr. 15000
oz. 529.5

Made of electric welded steel pipe, hot rolled $\varnothing 17$ mm-0.67"

CDR.0520

CdR S9 coil, for high pressure washers fitting **Comet**

Series:

- FDS
- KCB
- KCS
- KE CLASSIC
- KE SUPER mod. 8350, 8550, 8750
- KE EXTRA mod. 8350, 8550, 8750



gr. 25000
oz. 882.5

Made of electric welded steel pipe, hot rolled $\varnothing 17$ mm-0.67"

CDR.0673

CdR S27 coil, for high pressure washers fitting **Cristanini**

Series:

- BIG
- GHIBLETTE



gr. 14000
oz. 494.2

Made of steel pipe hot rolled $\varnothing 17$ mm-0.67"

CDR.0674

CdR S28 coil, for high pressure washers fitting **Cristanini**

Series:

- TEQUENDAMA
- TQ



gr. 24300
oz. 858.7

Made of steel pipe hot rolled $\varnothing 17$ mm-0.67"

CDR.0682

CdR S31 coil, for high pressure washers fitting **Cristanini**

Series:

- QUEEN



gr. 17400
oz. 614.3

Made of steel pipe hot rolled $\varnothing 17$ mm-0.67"



CDR.0523

CdR S12 coil, for high pressure washers fitting **Faip**

Series:

- INDY
- SUPER INDY



gr. 26500
oz. 962.0

Made of electric welded steel pipe, hot rolled $\varnothing 17$ mm- 0.67"

CDR.0522

CdR S11 coil, for high pressure washers fitting **Faip**

Series:

- PROFESSIONAL TOP
- mod. TK 15, TK 215



gr. 27500
oz. 998.2

Made of electric welded steel pipe, hot rolled $\varnothing 17$ mm- 0.67"

CDR.0683

CdR S32 coil, for high pressure washers fitting

- IDROMATIC
- TECNUEUROPA



gr. 25100
oz. 911,1

Made of steel pipe hot rolled $\varnothing 17$ mm-0.67"

TX.CN00020

CdR S35 coil, for high pressure washers **Idrobase**

Series:

- PRINCIPESSA



gr. 17400
oz. 631.6

Made of steel pipe hot rolled $\varnothing 17$ mm-0.67"

TX.01259

CdR S34 coil, for high pressure washers **Idrobase**

Series:

- STELLA



gr. 24300
oz. 882.1

Made of steel pipe hot rolled $\varnothing 17$ mm-0.67"

TX.CT00091

CdR S33 coil, for high pressure washers **Idrobase**

Series:

- GIGANTE
- (Except 275 bar 4000 psi version)



gr. 36800
oz. 1,335.8

Made of steel pipe hot rolled $\varnothing 17$ mm-0.67"

CDR.0675

CdR S29 coil, for high pressure washers fitting **ITM**

Series:

- MONDIAL



gr. 24200
oz. 878.5

Made of steel pipe hot rolled $\varnothing 17$ mm-0.67"

CDR.0670

CdR S24 coil, for high pressure washers fitting **Kärcher**

Series:

- K 855 HS
- K 855 HS DE LUXE

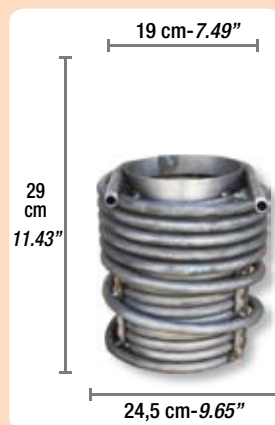

gr. 12400
oz. 450.1

Made of electric welded steel pipe, hot rolled $\varnothing 17$ mm- 0.67"

CDR.0440

CdR S3 coil, for high pressure washers fitting **Kärcher**

Series:

- K 855 HS
- K 855 PLUS
- K 855 HSL PLUS
- K 855 HS DE LUXE
- KB 802 C



gr. 14500
oz. 526.4

Made of electric welded steel pipe, hot rolled $\varnothing 17$ mm- 0.67"



CDR.0477

CdR S4 coil, for high pressure washers fitting **Kärcher**

HDS Series:

- 500 CI 698 C
- 501 C 698 CSX
- 550 C 700 C
- 555 C 790 C
- 555 CI 790 CI
- 557 CI 790 CS
- 590 C 797 CI
- 600 C 801 B
- 600 CI 890 C
- 600 CS 900 C
- 697 CI



gr. 19000
oz. 689.7

Made of electric welded steel pipe, hot rolled $\varnothing 17$ mm- 0.67"

CDR.0439

CdR S2 coil, for high pressure washers fitting **Kärcher**

HDS Series:

- 580 890
- 610 900
- 650 900B
- 690 990
- 750 1000BE
- 800B 1000DE
- 800BE 1200DE
- 810



gr. 22000
oz. 798.6

Made of electric welded steel pipe, hot rolled $\varnothing 17$ mm- 0.67"

CDR.0481

CdR S5 coil, for high pressure washers fitting **Kärcher**

HDS Series:

- 655 895
- 695 SPECIAL
- 695 s 895 SX
- 695 sx 945
- 699 995
- 745 1291 ST
- 755 SB-HDS
- 795 695
- 891 ST SUPER
- 895 S SUPER SX



gr. 26000
oz. 918.0

Made of electric welded steel pipe, hot rolled $\varnothing 17$ mm- 0.67"

CDR.0669

CdR S23 coil, for high pressure washers fitting **Kärcher**

HDS Series:

- 695 M 995 M
- ECO ECO
- 695 S M ECO
- EUR B/N/L
- 895 SUPER
- EUR
- 895 M SUPER M
- ECO ECO
- 895 S SB HDS
- EUR 695
- 895 4M SB HDS
- ECO 695 WERT
- 995 12/14,
- 995 EUR 9/14 ST



gr. 28000
oz. 1,016.4

Made of electric welded steel pipe, hot rolled $\varnothing 17$ mm- 0.67"

CDR.0438

CdR S1 coil, for high pressure washers fitting **Kärcher**

HDS Series:

- 1210
- 1250
- 1290
- 1390



gr. 35000
oz. 1,270.5

Made of electric welded steel pipe, hot rolled $\varnothing 17$ mm- 0.67"

CDR.0671

CdR S25 coil, for high pressure washers fitting **Kew**



gr. 31400
oz. 1,140.0

Made of electric welded steel pipe, hot rolled $\varnothing 17$ mm- 0.67"

CDR.0672

CdR S26 coil, for high pressure washers fitting **Fasa**

Series:

- KLIMAT
- SK2



gr. 14200
oz. 515.5

Made of steel pipe hot rolled $\varnothing 17$ mm-0.67"

CDR.0666

CdR S20 coil, for high pressure washers fitting **Lavor / Fasa**

Series:

- fitting **Lavor**:
- FKX
- RIO
- fitting **Fasa**:
- KAPPA



gr. 11800
oz. 428.4

Made of electric welded steel pipe, hot rolled $\varnothing 17$ mm- 0.67"

CDR.0667

CdR S21 coil, for high pressure washers fitting **Lavor / Fasa**

Series:

- fitting **Lavor**:
- PARANA
- mod. HOT 130
- mod. MISSOURI
- mod. YUKON
- fitting **Fasa**:
- KAIMAN



gr. 17100
oz. 620.8

Made of electric welded steel pipe, hot rolled $\varnothing 17$ mm- 0.67"



CDR.0519

CdR S8 coil, for high pressure washers fitting **Lavor / Fasa**

Series:

fitting **Lavor**:
- LKX
- NPX4

fitting **Fasa**:
- SUNDEK 55



gr. 27000
oz. 980.1

Made of electric welded steel pipe, hot rolled $\varnothing 17$ mm- 0.67"

CDR.0668

CdR S22 coil, for high pressure washers fitting **Lavor / Fasa**

Series:

fitting **Lavor**:
- TECHN4

fitting **Fasa**:
- MAXIMA



gr. 26500
oz. 962.0

Made of electric welded steel pipe, hot rolled $\varnothing 17$ mm- 0.67"

CDR.0660

CdR S14 coil, for high pressure washers fitting **Mazzoni**

Series:

- W 5050



gr. 31500
oz. 1,143.5

Made of electric welded steel pipe, hot rolled $\varnothing 17$ mm- 0.67"

CDR.0488

CdR P2 coil, for high pressure washers fitting **Portotecnica**

Series:

- FUTURA
- MISTRAL JET
- PROFFY mod. 2360T, 2960T, DS2360T, DS2575T, DS2960T
- GOLDEN JET
- FIRE BOX
- Faip HD 200



gr. 31000
oz. 1,125.3

Made of electric welded steel pipe, hot rolled $\varnothing 17$ mm- 0.67"

CDR.0659

CdR S13 coil, for high pressure washers fitting **Pulitecno**

Series:

- BINGO



gr. 11600
oz. 421.1

Made of electric welded steel pipe, hot rolled $\varnothing 17$ mm- 0.67"

CDR.0505

CdR S6 coil, for high pressure washers fitting **Sirio**

Series:

- MATCH BALL



gr. 23000
oz. 834.9

Made of electric welded steel pipe, hot rolled $\varnothing 17$ mm- 0.67"

CDR.0518

CdR S7 coil, for high pressure washers fitting **Sirio**

- SKIPPER



gr. 28000
oz. 1,016.4

Made of electric welded steel pipe, hot rolled $\varnothing 17$ mm- 0.67"

CDR.0676

CdR S30 coil, for high pressure washers fitting **Tecnomec**

Series:

- SYMBOL (up to 18 l/min- 4.75 USGpm)



gr. 27100
oz. 983.8



Made of steel pipe hot rolled $\varnothing 17$ mm-0.67"



Heating system - Thermostats

<p>ZX.0121 Thermostat 30-90 °C / 85-195 °F, 1500 mm isolated coil, probe 95x6,5 mm 3.75"x0.26"</p>  <p>gr. 180 oz. 6.4</p>	<p>ZX.0120 Thermostat 30 - 150 °C, / 85-300 °F 1500 mm isolated coil, probe 95x6,5 mm 3.75"x0.26"</p>  <p>gr. 180 oz. 6.4</p>	<p>ZX.0472 Thermostat 30 - 90 °C / 85-195 °F with switch, 1200 mm isolated coil, probe 95x6,5 mm 3.75"x0.26"</p>  <p>gr. 200 oz. 7.0</p>	<p>ZX.0275 Thermostat 30 - 150 °C, / 85-300 °F with switch, 1200 mm isolated coil, probe 95x6,5 mm 3.75"x0.26"</p>  <p>gr. 200 oz. 7.0</p>
<p>PG.X0000012 Knob for thermostat 30-90 °C / 85-195 °F (code ZX.0121, ZX.0472)</p>  <p>gr. 15 oz. 0.6</p>	<p>PG.X0000014 Knob for thermostat 30-150 °C / 85-300 °F (code ZX.0120, ZX.0275)</p>  <p>gr. 15 oz. 0.6</p>	<p>PG.X0000033 Ring for thermostat (code ZX.0121, ZX.0120, ZX.0472, ZX.0275)</p>  <p>gr. 5 oz. 0.2</p>	<p>CDR.0608 Brass case, for thermostat with probe 95x6,5 mm-3.75"x0.26"</p>  <p>gr. 75 oz. 2.7</p>
<p>CDR.7302 Nipple, G 1/2" - M 14x1, for thermostat with probe 95x6,5 mm-3.75"x0.26" (code ZX.0121, ZX.0120, ZX.0472, ZX.0275)</p>  <p>gr. 35 oz. 1.3</p>	<p>CDR.0598 Shaft for probe made of brass, 280 bar-4050 psi, 160 °C-320 °F 3xG 3/8" F - G 1/2" F for thermostat (code ZX.0121, ZX.0120, ZX.0472, ZX.0275)</p>  <p>gr. 70 oz. 2.5</p>	<p>CDR.0096 Level sensor fuel tank</p>  <p>gr. 70 oz. 2.5</p>	<p>CDR.0567 Black cap for fuel tank</p>  <p>gr. 24 oz. 0.9</p>

Heating system - Burner motors

<p>CDR.0531 Burner motor 150 W, 230 V-50 Hz, without pump drive</p>  <p>gr. 2820 oz. 99.6</p> <p><i>Clock and anticlockwise rotation</i></p>	<p>CDR.0532 Burner motor 150 W, 230 V-50 Hz, with pump drive ø32 mm-1.26"</p>  <p>gr. 2820 oz. 99.6</p> <p><i>Clock and anticlockwise rotation</i></p>	<p>CDR.0533 Burner motor 200 W, 380 V-50 Hz, with pump drive ø32 mm-1.26", fitting Portotecnica</p>  <p>gr. 2820 oz. 99.6</p> <p><i>Clock and anticlockwise rotation</i></p>
---	---	---

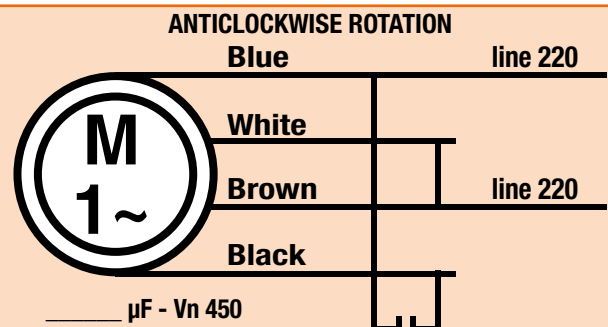
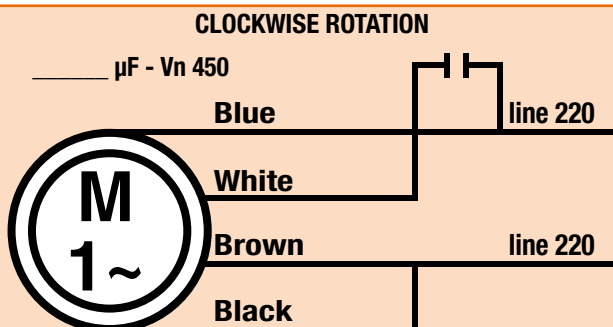

Heating system - Burner motors

<p>Z.0399</p> <p>Plastic drive, SM</p>  <p>gr. 2 oz. 0.1</p>	<p>CDR.0301</p> <p>Plastic drive, fitting Faip TK</p>  <p>gr. 2 oz. 0.1</p>	<p>ED.GNTD</p> <p>Plastic drive, D</p>  <p>gr. 2 oz. 0.1</p>	<p>ED.GNTE</p> <p>Plastic drive, E</p>  <p>gr. 2 oz. 0.1</p>
<p>ED.GNTF</p> <p>Plastic drive, F</p>  <p>gr. 2 oz. 0.1</p>	<p>ED.GNTH</p> <p>Plastic drive, H</p>  <p>gr. 2 oz. 0.1</p>	<p>ED.GNTM</p> <p>Plastic drive, M</p>  <p>gr. 2 oz. 0.1</p>	<p>ED.GNT3PZ</p> <p>Plastic drive, S.Andrea (3 pcs)</p>  <p>gr. 18 oz. 0.7</p>

Heating system

<p>TX.0099</p> <p>HORIZONTAL heater black painted steel cover shirt:</p> <ul style="list-style-type: none"> - Efficiency: 89% - Fuel nozzle: 0.85gl/h - Fuel consumption: 3,20kg/h <p>Pre-assembled and tested professional horizontal heater. Coil made of double steel pipe, air isolation, black painted steel. Ignition transformer 1x230V-50Hz, 18mA, 2x4000V, burner motor 250V-50Hz, 150W, fuel pump with solenoid valve 240V.</p>  <p>gr. 35.000 oz. 1,236.0</p> <p>33.000 K/cal, 220 bar-3200 psi, 8-11 l/min - 2.11-2.90 USGpm</p>	<p>TX.01236</p> <p>VERTICAL heater gray painted steel cover shirt:</p> <ul style="list-style-type: none"> - Efficiency: 90% - Fuel nozzle: 1.50 - Fuel consumption: 5,70kg/h <p>Pre-assembled and tested professional vertical heater. Coil made of double steel pipe, stainless steel internal shirt and gray painted steel external shirt and cover. Ignition transformer 1x230V-50Hz, 18mA, 2x4000V, burner motor 250V-50Hz, 150W, fuel pump with solenoid valve 240V.</p>  <p>gr. 50.000 oz. 1,765.0</p> <p>58.000 K/cal, 220 bar-3200 psi, 13-20 l/min - 3.40-5.30 USGpm</p>
<p>TX.01237</p> <p>VERTICAL heater made of stainless steel:</p> <ul style="list-style-type: none"> - Efficiency: 91% - Fuel nozzle: 2.00gl/h - Fuel consumption: 7,60kg/h <p>Pre-assembled and tested vertical heater with air isolation device, suitable for professional use. Coil made of double steel pipe, stainless steel cover, internal and external shirt. Ignition transformer 1x230V-50Hz, 18mA, 2x4000V, burner motor 250V-50Hz, 150W, fuel pump with solenoid valve 24V.</p>  <p>gr. 50.000 oz. 1,765.0</p> <p>77.500 K/cal, 220 bar-3200 psi, 18-21 l/min - 4.70-5.50 USGpm</p>	<p>TX.0005</p> <p>VERTICAL heater made of stainless steel:</p> <ul style="list-style-type: none"> - Efficiency: 91% - Fuel nozzle: 2.00gl/h - Fuel consumption: 7,60kg/h <p>Pre-assembled and tested vertical heater with air isolation device, suitable for contunuvative use. Coil made of double steel pipe, stainless steel cover, internal and external shirt. Ignition transformer 1x230V-50Hz, 18mA, 2x4000V, burner motor 250V-50Hz, 150W, fuel pump with solenoid valve 24V.</p>  <p>gr. 60.000 oz. 2,118.0</p> <p>77.500 K/cal, 300 bar-4350 psi, 18-21 l/min - 4.70-5.50 USGpm</p>

Riparaton®

Club dei
Riparaton®

Club dei
Riparaton®

OUR LINE OF HIGH PRESSURE HOSES



From today Club dei Riparatori **assembles your hoses**. A brand new innovation, the HIGH PRESSURE HOSES catalogue for high pressure washers.

From today CdR gives you the opportunity to buy:

- High pressure hoses with standard fittings.
- High pressure hoses in pieces with all of the fittings needed for you to assemble your own hoses.
- High pressure hoses and fittings assembled according to your request.



Quality

*The hoses by Club dei Riparatori
are of the highest quality.*

Prices

*A bargain!
Because the hoses
are assembled directly by us.*



Time of delivery

*On average goods dispatched
within 3 days of receipt
of your order*

Minimum quantity

*There is no minimum quantity to order
(except for hoses made to measure).*





High pressure hoses - Technical features

The spare parts branded "CdR" exclusively refer to products by Club dei Riparatori® by IDROBASE®

210 bar-3050 psi R1 1/4" - BLACK HIGH PRESSURE HOSE

• For high pressure hot water cleaning applications

- Suitable for cold and hot water, and detergent solutions resistant, special black synthetic rubber. Oil, high abrasion and weather resistant.

Hose	Wires	Ø Inside	Ø Outside	Working pressure	Burst pressure	Temperature	Colour
1/4"	R1	6,4 mm 0.25"	12,2 mm 0.48"	210 bar 3050 psi	840 bar 12200 psi	-40 °C / +150 °C -105 °F / +300 °F	BLACK BLUE

210 bar-3050 psi R1 3/8" - BLACK & BLUE HIGH PRESSURE HOSE

• For high pressure hot water cleaning applications

- Suitable for cold and hot water, and detergent solutions resistant, special black synthetic rubber. Oil, high abrasion and weather resistant.

Hose	Wires	Ø Inside	Ø Outside	Working pressure	Burst pressure	Temperature	Colour
3/8"	R1	9.5 mm 0.37"	17,2 mm 0.68"	210 bar 3050 psi	840 bar 12200 psi	-40 °C / +150 °C -105 °F / +300 °F	BLACK BLUE

315 bar-4550 psi R1 5/16" - BLACK & BLUE HIGH PRESSURE HOSE

• For high pressure hot water cleaning applications

- Suitable for cold and hot water, and detergent solutions resistant, special blue & black synthetic rubber. Oil, high abrasion and weather resistant.

Hose	Wires	Ø Inside	Ø Outside	Working pressure	Burst pressure	Temperature	Colour
5/16"	R1	7,9 mm 0.31"	15,0 mm 0.59"	315 bar 4550 psi	1260 bar 18250 psi	-40 °C / +150 °C -105 °F / +300 °F	BLACK BLUE

400 bar-5800 psi R2 5/16" - BLACK & BLUE HIGH PRESSURE HOSE

• For high pressure hot water cleaning applications

- Suitable for cold and hot water, and detergent solutions resistant, special blue & black synthetic rubber. Oil, high abrasion and weather resistant.

Hose	Wires	Ø Inside	Ø Outside	Working pressure	Burst pressure	Temperature	Colour
5/16"	R2	7,9 mm 0.31"	15,0 mm 0.59"	400 bar 5800 psi	1600 bar 23200 psi	-40 °C / +150 °C -105 °F / +300 °F	BLACK BLUE

400 bar-5800 psi R2 3/8" - BLACK & BLUE HIGH PRESSURE HOSE

• For high pressure hot water cleaning applications

- Suitable for cold and hot water, and detergent solutions resistant, special blue & black synthetic rubber. Oil, high abrasion and weather resistant.

Hose	Wires	Ø Inside	Ø Outside	Working pressure	Burst pressure	Temperature	Colour
3/8"	R2	9,5 mm 0.37"	18,9 mm 0.74"	400 bar 5800 psi	1600 bar 23200 psi	-40 °C / +150 °C -105 °F / +300 °F	BLACK BLUE

500 bar-7250 psi R2 3/8" - BLACK HIGH PRESSURE HOSE

• For high pressure hot water cleaning applications

- Suitable for cold and hot water, and detergent solutions resistant, special black synthetic rubber. Oil, high abrasion and weather resistant.

Hose	Wires	Ø Inside	Ø Outside	Working pressure	Burst pressure	Temperature	Colour
3/8"	R2	9,5 mm 0.37"	17,8 mm 0.70"	500 bar 7250 psi	2000 bar 23200 psi	-40 °C / +150 °C -105 °F / +300 °F	BLACK

210 bar-3050 psi R7 3/16" - BLACK HIGH PRESSURE HOSE

• For cleaning applications using high pressure cold water

- Construction: core made of a weld-free mixture of polyethylene, reinforced with high tenacity synthetic fibre and covered with anti-abrasive synthetic rubber casing.

Hose	Wires	Ø Inside	Ø Outside	Working pressure	Burst pressure	Temperature	Colour
3/16"	R7	5 mm 0.20"	9,6 mm 0.38"	210 bar 3050 psi	840 bar 12200 psi	-40 °C / +70 °C -105 °F / +160 °F	BLACK

140 bar-2000 psi THERMOPLASTIC HOSE - BLACK HIGH PRESSURE HOSE

• For cleaning applications using high pressure cold water



- Construction: core made of a weld-free mixture of polyethylene, reinforced with high tenacity synthetic fibre and covered with anti-abrasive synthetic rubber casing.



Hose	Ø Inside	Ø Outside	Working pressure	Burst pressure	Temperature	Colour
1/4"	6,3 mm 0.25"	12 mm 0.48"	140 bar 2000 psi	560 bar 8100 psi	-40 °C / +70 °C -105 °F / +160 °F	BLACK







H.p. hoses 210 bar(3050 psi) - R1 1/4" - Pre-assembled



The spare parts branded "CdR" exclusively refer to products by Club dei Riparatori® by IDROBASE®



BLACK	Code	Length		Weight
		m	ft	
	ZN.AC080X1R1R	8	26.25	gr. 1590 oz. 55.7
	ZN.AC100X1R1R	10	32.80	gr. 1960 oz. 68.6
	ZN.AC150X1R1R	15	49.20	gr. 2880 oz. 100.8
	ZN.AC200X1R1R	20	65.60	gr. 3810 oz. 133.4
<i>Without handles</i>				



BLACK	Code	Length		Weight
		m	ft	
	ZN.AC080X1S1R	8	26.25	gr. 1580 oz. 55.3
	ZN.AC100X1S1R	10	32.80	gr. 1950 oz. 68.3
	ZN.AC150X1S1R	15	49.20	gr. 2870 oz. 100.5
	ZN.AC200X1S1R	20	65.60	gr. 3800 oz. 133.0
<i>Without handles</i>				



BLACK	Code	Length		Weight
		m	ft	
	ZN.AC080X1R1T	8	26.25	gr. 1600 oz. 56.0
	ZN.AC100X1R1T	10	32.80	gr. 1970 oz. 69.0
	ZN.AC150X1R1T	15	49.20	gr. 2880 oz. 100.8
	ZN.AC200X1R1T	20	65.60	gr. 3810 oz. 133.4
<i>Without handles</i>				



BLACK	Code	Length		Weight
		m	ft	
	ZN.AC080X1T1T	8	26.25	gr. 1610 oz. 56.4
	ZN.AC100X1T1T	10	32.80	gr. 1980 oz. 69.3
	ZN.AC150X1T1T	15	49.20	gr. 2890 oz. 101.2
	ZN.AC200X1T1T	20	65.60	gr. 3820 oz. 133.7
<i>Without handles</i>				

BLACK	Code	Length		Weight
		m	ft	
	ZN.AC080X1U1T	8	26.25	gr. 1610 oz. 56.4
	ZN.AC100X1U1T	10	32.80	gr. 1980 oz. 69.3
	ZN.AC150X1U1T	15	49.20	gr. 2890 oz. 101.2
	ZN.AC200X1U1T	20	65.60	gr. 3820 oz. 133.7
<i>Without handles</i>				

BLACK	Code	Length		Weight
		m	ft	
	ZN.AC080X2P1R	8	26.25	gr. 1630 oz. 57.1
	ZN.AC100X2P1R	10	32.80	gr. 2000 oz. 70.0
	ZN.AC150X2P1R	15	49.20	gr. 2910 oz. 101.9
	ZN.AC200X2P1R	20	65.60	gr. 3840 oz. 134.4
<i>Without handles</i>				

BLACK	Code	Length		Weight
		m	ft	
	ZN.AC080X2P1S	8	26.25	gr. 1630 oz. 57.1
	ZN.AC100X2P1S	10	32.80	gr. 2000 oz. 70.0
	ZN.AC150X2P1S	15	49.20	gr. 2910 oz. 101.9
	ZN.AC200X2P1S	20	65.60	gr. 3840 oz. 134.4
<i>Without handles</i>				

BLACK	Code	Length		Weight
		m	ft	
	ZN.AC080X2P1T	8	26.25	gr. 1640 oz. 57.4
	ZN.AC100X2P1T	10	32.80	gr. 2010 oz. 70.4
	ZN.AC150X2P1T	15	49.20	gr. 2920 oz. 102.2
	ZN.AC200X2P1T	20	65.60	gr. 3850 oz. 134.8
<i>Without handles</i>				

BLACK	Code	Length		Weight
		m	ft	
	ZN.AC080X2P1U	8	26.25	gr. 1640 oz. 57.4
	ZN.AC100X2P1U	10	32.80	gr. 2010 oz. 70.4
	ZN.AC150X2P1U	15	49.20	gr. 2920 oz. 102.2
	ZN.AC200X2P1U	20	65.60	gr. 3850 oz. 134.8
<i>Without handles</i>				



BLACK	Code	Length		Weight
		m	ft	
	ZN.AC080X2P2P	8	26.25	gr. 1670 oz. 58.5
	ZN.AC100X2P2P	10	32.80	gr. 2040 oz. 71.4
	ZN.AC150X2P2P	15	49.20	gr. 2960 oz. 103.6
	ZN.AC200X2P2P	20	65.60	gr. 3890 oz. 136.2
<i>Without handles</i>				





H.p. hoses 210 bar(3050 psi) - R1 1/4" - Pre-assembled



The spare parts branded "CdR" exclusively refer to products by Club dei Riparatori® by IDROBASE®

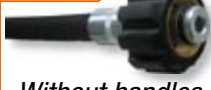

BLACK		Code	Length m ft	Weight
 M 22ø14 F fitting ø10 K  Without handles	ZN.AC080X2P50	8 26.25	gr. 1660 oz. 58.1	
	ZN.AC100X2P50	10 32.80	gr. 2030 oz. 71.1	
	ZN.AC150X2P50	15 49.20	gr. 2950 oz. 103.3	
	ZN.AC200X2P50	20 65.60	gr. 3880 oz. 135.8	



BLACK		Code	Length m ft	Weight
 M 22ø14 F long fitting ø10 K  Without handles	ZN.AC080X3E50	8 26.25	gr. 1670 oz. 58.5	
	ZN.AC100X3E50	10 32.80	gr. 2040 oz. 71.4	
	ZN.AC150X3E50	15 49.20	gr. 2960 oz. 103.6	
	ZN.AC200X3E50	20 65.60	gr. 3890 oz. 136.2	



BLACK		Code	Length m ft	Weight
 M 22ø14 F long M 22ø14 F  Without handles	ZN.AC080X3E2P	8 26.25	gr. 1680 oz. 58.8	
	ZN.AC100X3E2P	10 32.80	gr. 2050 oz. 71.8	
	ZN.AC150X3E2P	15 49.20	gr. 2970 oz. 104.0	
	ZN.AC200X3E2P	20 65.60	gr. 3900 oz. 136.5	



BLACK		Code	Length m ft	Weight
 M 22ø15 F G 1/4" F  Without handles	ZN.AC080X5M1R	8 26.25	gr. 1630 oz. 57.1	
	ZN.AC100X5M1R	10 32.80	gr. 2000 oz. 70.0	
	ZN.AC150X5M1R	15 49.20	gr. 2930 oz. 102.6	
	ZN.AC200X5M1R	20 65.60	gr. 3850 oz. 134.8	



BLACK		Code	Length m ft	Weight
 M 22ø15 F G 3/8" F  Without handles	ZN.AC080X5M1T	8 26.25	gr. 1640 oz. 57.4	
	ZN.AC100X5M1T	10 32.80	gr. 2010 oz. 70.4	
	ZN.AC150X5M1T	15 49.20	gr. 2920 oz. 102.2	
	ZN.AC200X5M1T	20 65.60	gr. 3850 oz. 134.8	

BLACK		Code	Length m ft	Weight
 M 22ø15 F G 3/8" M  Without handles	ZN.AC080X5M1U	8 26.25	gr. 1640 oz. 57.4	
	ZN.AC100X5M1U	10 32.80	gr. 2010 oz. 70.4	
	ZN.AC150X5M1U	15 49.20	gr. 2920 oz. 102.2	
	ZN.AC200X5M1U	20 65.60	gr. 3850 oz. 134.8	

BLACK		Code	Length m ft	Weight
 M 21ø14 F G 1/4" F  Without handles	ZN.AC080X3H1R	8 26.25	gr. 1620 oz. 56.7	
	ZN.AC100X3H1R	10 32.80	gr. 1990 oz. 69.7	
	ZN.AC150X3H1R	15 49.20	gr. 2920 oz. 102.2	
	ZN.AC200X3H1R	20 65.60	gr. 3840 oz. 134.4	

BLACK		Code	Length m ft	Weight
 M 21ø14 F G 3/8" F  Without handles	ZN.AC080X3H1T	8 26.25	gr. 1630 oz. 57.1	
	ZN.AC100X3H1T	10 32.80	gr. 2000 oz. 70.0	
	ZN.AC150X3H1T	15 49.20	gr. 2930 oz. 102.6	
	ZN.AC200X3H1T	20 65.60	gr. 3850 oz. 134.8	

BLACK		Code	Length m ft	Weight
 M 21ø14 F G 3/8" M  Without handles	ZN.AC080X3H1U	8 26.25	gr. 1630 oz. 57.1	
	ZN.AC100X3H1U	10 32.80	gr. 2000 oz. 70.0	
	ZN.AC150X3H1U	15 49.20	gr. 2930 oz. 102.6	
	ZN.AC200X3H1U	20 65.60	gr. 3850 oz. 134.8	

BLACK		Code	Length m ft	Weight
 M 21ø14 F M 21ø14 F  Without handles	ZN.AC080X3H3H	8 26.25	gr. 1660 oz. 58.1	
	ZN.AC100X3H3H	10 32.80	gr. 2030 oz. 71.1	
	ZN.AC150X3H3H	15 49.20	gr. 2950 oz. 103.3	
	ZN.AC200X3H3H	20 65.60	gr. 3880 oz. 135.8	



H.p. hoses 210 bar(3050 psi) - R1 3/8" - Pre-assembled

The spare parts branded "CdR" exclusively refer to products by Club dei Riparatori® by IDROBASE®

BLACK	Code	Length m ft	Weight
	ZN.BC100B2D2D	10 32.80	gr. 3790 oz. 132.7
G 3/8" F			
	ZN.BC150B2D2D	15 49.20	gr. 5510 oz. 192.9
G 3/8" F			
	ZN.BC200B2D2D	20 65.60	gr. 7240 oz. 253.4
<i>With handles</i>			

BLACK	Code	Length m ft	Weight
	ZN.BC100B2E2D	10 32.80	gr. 3780 oz. 132.3
G 3/8" M			
	ZN.BC150B2E2D	15 49.20	gr. 5510 oz. 192.9
G 3/8" F			
	ZN.BC200B2E2D	20 65.60	gr. 7230 oz. 253.1
<i>With handles</i>			

BLACK	Code	Length m ft	Weight
	ZN.BC100B2F2F	10 32.80	gr. 3840 oz. 134.4
G 1/2" F			
	ZN.BC150B2F2F	15 49.20	gr. 5560 oz. 194.6
G 1/2" F			
	ZN.BC200B2F2F	20 65.60	gr. 7290 oz. 255.2
<i>With handles</i>			

BLACK	Code	Length m ft	Weight
	ZN.BC100B2G2F	10 32.80	gr. 3830 oz. 134.1
G 1/2" M			
	ZN.BC150B2G2F	15 49.20	gr. 5560 oz. 194.6
G 1/2" F			
	ZN.BC200B2G2F	20 65.60	gr. 7280 oz. 254.8
<i>With handles</i>			

BLACK	Code	Length m ft	Weight
	ZN.BC100B2O2D	10 32.80	gr. 3800 oz. 133.0
1/2" F swivel			
	ZN.BC150B2O2D	15 49.20	gr. 5520 oz. 193.2
G 3/8" F			
	ZN.BC200B2O2D	20 65.60	gr. 7250 oz. 253.8
<i>With handles</i>			

BLACK	Code	Length m ft	Weight
	ZN.BC100B2O2E	10 32.80	gr. 3790 oz. 132.7
1/2" F swivel			
	ZN.BC150B2O2E	15 49.20	gr. 5520 oz. 193.2
G 3/8" M			
	ZN.BC200B2O2E	20 65.60	gr. 7240 oz. 253.4
<i>With handles</i>			

BLACK	Code	Length m ft	Weight
	ZN.BC100B2O2F	10 32.80	gr. 3820 oz. 133.7
1/2" F swivel			
	ZN.BC150B2O2F	15 49.20	gr. 5550 oz. 194.3
G 1/2" F			
	ZN.BC200B2O2F	20 65.60	gr. 7250 oz. 254.5
<i>With handles</i>			

BLACK	Code	Length m ft	Weight
	ZN.BC100B2O2G	10 32.80	gr. 3820 oz. 133.7
1/2" F swivel			
	ZN.BC150B2O2G	15 49.20	gr. 5540 oz. 193.9
G 1/2" M			
	ZN.BC200B2O2G	20 65.60	gr. 7250 oz. 254.5
<i>With handles</i>			

BLACK	Code	Length m ft	Weight
	ZN.BC100B4N2D	10 32.80	gr. 3810 oz. 133.4
M 22ø14 F			
	ZN.BC150B4N2D	15 49.20	gr. 5540 oz. 193.9
G 3/8" F			
	ZN.BC200B4N2D	20 65.60	gr. 7260 oz. 254.1
<i>With handles</i>			

BLACK	Code	Length m ft	Weight
	ZN.BC100B4N2E	10 32.80	gr. 3810 oz. 133.4
M 22ø14 F			
	ZN.BC150B4N2E	15 49.20	gr. 5530 oz. 193.6
G 3/8" M			
	ZN.BC200B4N2E	20 65.60	gr. 7260 oz. 254.1
<i>With handles</i>			



H.p. hoses 210 bar(3050 psi) - R1 3/8" - Pre-assembled

The spare parts branded "CdR" exclusively refer to products by Club dei Riparatori® by IDROBASE®

BLACK		Code	Length m ft	Weight
	ZN.BC100B4N4N	10 32.80	gr. 3840 oz. 134.4	
M 22ø14 F				
	ZN.BC150B4N4N	15 49.20	gr. 5560 oz. 194.6	
M 22ø14 F				
	ZN.BC200B4N4N	20 65.60	gr. 7290 oz. 255.2	
G 3/8" F				
<i>With handles</i>				

BLACK		Code	Length m ft	Weight
	ZN.BC100B5B2D	10 32.80	gr. 3820 oz. 133.7	
M 22ø14 F long				
	ZN.BC150B5B2D	15 49.20	gr. 5550 oz. 192.5	
G 3/8" F				
	ZN.BC200B5B2D	20 65.60	gr. 7270 oz. 254.5	
G 3/8" F				
<i>With handles</i>				

BLACK		Code	Length m ft	Weight
	ZN.BC100B5B2E	10 32.80	gr. 3820 oz. 133.7	
M 22ø14 F long				
	ZN.BC150B5B2E	15 49.20	gr. 5540 oz. 193.9	
G 3/8" M				
	ZN.BC200B5B2E	20 65.60	gr. 7270 oz. 254.5	
G 3/8" M				
<i>With handles</i>				

BLACK		Code	Length m ft	Weight
	ZN.BC100B5B4N	10 32.80	gr. 3850 oz. 134.8	
M 22ø14 F long				
	ZN.BC150B5B4N	15 49.20	gr. 5570 oz. 195.0	
M 22ø14 F				
	ZN.BC200B5B4N	20 65.60	gr. 7300 oz. 255.5	
G 3/8" M				
<i>With handles</i>				

BLACK		Code	Length m ft	Weight
	ZN.BC100B5F2D	10 32.80	gr. 3810 oz. 133.4	
M 21ø14 F				
	ZN.BC150B5F2D	15 49.20	gr. 5530 oz. 193.6	
G 3/8" F				
	ZN.BC200B5F2D	20 65.60	gr. 7260 oz. 254.1	
G 3/8" F				
<i>With handles</i>				

BLACK		Code	Length m ft	Weight
	ZN.BC100B5F2E	10 32.80	gr. 3800 oz. 133.0	
M 21ø14 F				
	ZN.BC150B5F2E	15 49.20	gr. 5530 oz. 193.6	
G 3/8" M				
	ZN.BC200B5F2E	20 65.60	gr. 7250 oz. 253.8	
G 3/8" M				
<i>With handles</i>				

BLACK		Code	Length m ft	Weight
	ZN.BC100B5F5F	10 32.80	gr. 3830 oz. 134.1	
M 21ø14 F				
	ZN.BC150B5F5F	15 49.20	gr. 5550 oz. 194.3	
M 21ø14 F				
	ZN.BC200B5F5F	20 65.60	gr. 7280 oz. 254.8	
G 3/8" M				
<i>With handles</i>				

BLACK		Code	Length m ft	Weight
	ZN.BC100B5F4N	10 32.80	gr. 3830 oz. 134.1	
M 21ø14 F				
	ZN.BC150B5F4N	15 49.20	gr. 5560 oz. 194.6	
M 22ø14 F				
	ZN.BC200B5F4N	20 65.60	gr. 7280 oz. 254.8	
G 3/8" M				
<i>With handles</i>				



BLUE		Code	Length m ft	Weight
	ZB.BC100D2D2D	10 32.80	gr. 3840 oz. 134.4	
G 3/8" F				
	ZB.BC150D2D2D	15 49.20	gr. 5590 oz. 195.7	
G 3/8" F				
	ZB.BC200D2D2D	20 65.60	gr. 7340 oz. 256.9	
G 3/8" F				
<i>With handles</i>				



BLUE		Code	Length m ft	Weight
	ZB.BC100D2F2F	10 32.80	gr. 3890 oz. 136.2	
G 1/2" F				
	ZB.BC150D2F2F	15 49.20	gr. 5640 oz. 197.4	
G 1/2" F				
	ZB.BC200D2F2F	20 65.60	gr. 7390 oz. 258.7	
G 1/2" F				
<i>With handles</i>				









H.p. hoses 210 bar(3050 psi) - R1 3/8" - Pre-assembled



The spare parts branded "CdR" exclusively refer to products by Club dei Riparatori® by IDROBASE®

BLUE	Code	Length		Weight
		m	ft	
	ZB.BC100D202D	10	32.80	gr. 3850 oz. 134.8
	ZB.BC150D202D	15	49.20	gr. 5600 oz. 196.0
	ZB.BC200D202D	20	65.60	gr. 7350 oz. 257.3



BLUE	Code	Length		Weight
		m	ft	
	ZB.BC100D202F	10	32.80	gr. 3870 oz. 135.5
	ZB.BC150D202F	15	49.20	gr. 5620 oz. 196.7
	ZB.BC200D202F	20	65.60	gr. 7380 oz. 258.0

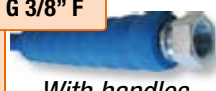

BLUE	Code	Length		Weight
		m	ft	
	ZB.BC100D4N2D	10	32.80	gr. 3860 oz. 135.1
	ZB.BC150D4N2D	15	49.20	gr. 5610 oz. 196.4
	ZB.BC200D4N2D	20	65.60	gr. 7360 oz. 257.6



BLUE	Code	Length		Weight
		m	ft	
	ZB.BC100D4N4N	10	32.80	gr. 3890 oz. 136.2
	ZB.BC150D4N4N	15	49.20	gr. 5640 oz. 197.4
	ZB.BC200D4N4N	20	65.60	gr. 7390 oz. 258.7

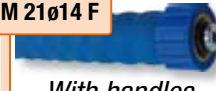

BLUE	Code	Length		Weight
		m	ft	
	ZB.BC100D5B2D	10	32.80	gr. 3870 oz. 135.5
	ZB.BC150D5B2D	15	49.20	gr. 5620 oz. 196.7
	ZB.BC200D5B2D	20	65.60	gr. 7370 oz. 258.0



BLUE	Code	Length		Weight
		m	ft	
	ZB.BC100D5B4N	10	32.80	gr. 3900 oz. 136.5
	ZB.BC150D5B4N	15	49.20	gr. 5650 oz. 197.8
	ZB.BC200D5B4N	20	65.60	gr. 7400 oz. 259.0

BLUE	Code	Length		Weight
		m	ft	
	ZB.BC100D5F2D	10	32.80	gr. 3860 oz. 135.1
	ZB.BC150D5F2D	15	49.20	gr. 5610 oz. 196.4
	ZB.BC200D5F2D	20	65.60	gr. 7360 oz. 257.6

BLUE	Code	Length		Weight
		m	ft	
	ZB.BC100D5F5F	10	32.80	gr. 3880 oz. 135.8
	ZB.BC150D5F5F	15	49.20	gr. 5630 oz. 197.1
	ZB.BC200D5F5F	20	65.60	gr. 7380 oz. 258.3

BLUE WITH SS AISI 316 FITTINGS	Code	Length		Weight
		m	ft	
	ZB.BC100D2J2J	10	32.80	gr. 3840 oz. 134.4
	ZB.BC150D2J2J	15	49.20	gr. 5590 oz. 195.7
	ZB.BC200D2J2J	20	65.60	gr. 7340 oz. 256.9

BLUE WITH SS AISI 316 FITTINGS	Code	Length		Weight
		m	ft	
	ZB.BC100D2K2K	10	32.80	gr. 3890 oz. 136.2
	ZB.BC150D2K2K	15	49.20	gr. 5640 oz. 197.4
	ZB.BC200D2K2K	20	65.60	gr. 7390 oz. 258.7

BLUE WITH SS AISI 316 FITTINGS	Code	Length		Weight
		m	ft	
	ZB.BC100D2V2V	10	32.80	gr. 3960 oz. 138.6
	ZB.BC150D2V2V	15	49.20	gr. 5710 oz. 199.9
	ZB.BC200D2V2V	20	65.60	gr. 7460 oz. 261.1

Club dei Riparatori®



A complete range of components and solutions to repair any kind of high pressure washer.



H.p. hoses 315 bar(4550 psi) - R1 5/16"

- Pre-assembled

The spare parts branded "CdR" exclusively refer to products by Club dei Riparatori® by IDROBASE®

BLACK	Code	Length		Weight
		m	ft	
	ZN.CC080B1Z1Z	8	26.25	gr. 2580 oz. 90.3
	ZN.CC100B1Z1Z	10	32.80	gr. 3140 oz. 109.9
	ZN.CC150B1Z1Z	15	49.20	gr. 4540 oz. 158.9
	ZN.CC200B1Z1Z	20	65.60	gr. 5940 oz. 207.9

With handles

BLACK	Code	Length		Weight
		m	ft	
	ZN.CC080B2A1Z	8	26.25	gr. 2570 oz. 90.0
	ZN.CC100B2A1Z	10	32.80	gr. 3130 oz. 109.6
	ZN.CC150B2A1Z	15	49.20	gr. 4530 oz. 158.6
	ZN.CC200B2A1Z	20	65.60	gr. 5930 oz. 207.6

With handles

BLACK	Code	Length		Weight
		m	ft	
	ZN.CC080B2B2B	8	26.25	gr. 2630 oz. 92.1
	ZN.CC100B2B2B	10	32.80	gr. 3190 oz. 111.7
	ZN.CC150B2B2B	15	49.20	gr. 4590 oz. 160.7
	ZN.CC200B2B2B	20	65.60	gr. 5990 oz. 209.7

With handles

BLACK	Code	Length		Weight
		m	ft	
	ZN.CC080B2C2B	8	26.25	gr. 2620 oz. 91.7
	ZN.CC100B2C2B	10	32.80	gr. 3180 oz. 111.3
	ZN.CC150B2C2B	15	49.20	gr. 4580 oz. 160.3
	ZN.CC200B2C2B	20	65.60	gr. 5980 oz. 209.3

With handles

BLACK	Code	Length		Weight
		m	ft	
	ZN.CC080B2N1Z	8	26.25	gr. 2590 oz. 90.7
	ZN.CC100B2N1Z	10	32.80	gr. 3150 oz. 110.3
	ZN.CC150B2N1Z	15	49.20	gr. 4550 oz. 159.3
	ZN.CC200B2N1Z	20	65.60	gr. 5950 oz. 208.3

With handles

BLACK	Code	Length		Weight
		m	ft	
	ZN.CC080B2N2A	8	26.25	gr. 2580 oz. 90.3
	ZN.CC100B2N2A	10	32.80	gr. 3140 oz. 109.9
	ZN.CC150B2N2A	15	49.20	gr. 4540 oz. 158.9
	ZN.CC200B2N2A	20	65.60	gr. 5940 oz. 207.9

With handles

BLACK	Code	Length		Weight
		m	ft	
	ZN.CC080B2N3P	8	26.25	gr. 2610 oz. 91.4
	ZN.CC100B2N3P	10	32.80	gr. 3170 oz. 111.0
	ZN.CC150B2N3P	15	49.20	gr. 4570 oz. 160.0
	ZN.CC200B2N3P	20	65.60	gr. 5970 oz. 209.0

With handles

BLACK	Code	Length		Weight
		m	ft	
	ZN.CC080B3P1Z	8	26.25	gr. 2600 oz. 91.0
	ZN.CC100B3P1Z	10	32.80	gr. 3160 oz. 110.6
	ZN.CC150B3P1Z	15	49.20	gr. 4560 oz. 159.6
	ZN.CC200B3P1Z	20	65.60	gr. 5960 oz. 208.6

With handles

BLACK	Code	Length		Weight
		m	ft	
	ZN.CC080B3P2A	8	26.25	gr. 2600 oz. 91.0
	ZN.CC100B3P2A	10	32.80	gr. 3160 oz. 110.6
	ZN.CC150B3P2A	15	49.20	gr. 4560 oz. 159.6
	ZN.CC200B3P2A	20	65.60	gr. 5960 oz. 208.6

With handles

BLACK	Code	Length		Weight
		m	ft	
	ZN.CC080B3P3P	8	26.25	gr. 2630 oz. 92.1
	ZN.CC100B3P3P	10	32.80	gr. 3190 oz. 111.7
	ZN.CC150B3P3P	15	49.20	gr. 4590 oz. 160.7
	ZN.CC200B3P3P	20	65.60	gr. 5990 oz. 209.7

With handles

BLACK	Code	Length		Weight
		m	ft	
	ZN.CC080B4D1Z	8	26.25	gr. 2610 oz. 91.4
	ZN.CC100B4D1Z	10	32.80	gr. 3170 oz. 111.0
	ZN.CC150B4D1Z	15	49.20	gr. 4570 oz. 160.0
	ZN.CC200B4D1Z	20	65.60	gr. 5970 oz. 209.0

With handles

BLACK	Code	Length		Weight
		m	ft	
	ZN.CC080B4D2A	8	26.25	gr. 2610 oz. 91.4
	ZN.CC100B4D2A	10	32.80	gr. 3170 oz. 111.0
	ZN.CC150B4D2A	15	49.20	gr. 4570 oz. 160.0
	ZN.CC200B4D2A	20	65.60	gr. 5970 oz. 209.0

With handles





H.p. hoses 315 bar(4550 psi) - R1 5/16"

- Pre-assembled

The spare parts branded "CdR" exclusively refer to products by Club dei Riparatori® by IDROBASE®

BLACK	Code	Length		Weight
		m	ft	
 M 22ø14 F long M 22ø14 F With handles	ZN.CC080B4D3P	8	26.25	gr. 2640 oz. 92.4
	ZN.CC100B4D3P	10	32.80	gr. 3200 oz. 112.0
	ZN.CC150B4D3P	15	49.20	gr. 4600 oz. 161.0
	ZN.CC200B4D3P	20	65.60	gr. 6000 oz. 210.0

BLACK	Code	Length		Weight
		m	ft	
 M 22ø14 F long fitting ø10 K ø14 With handles	ZN.CC080A4D5P	8	26.25	gr. 2540 oz. 88.9
	ZN.CC100A4D5P	10	32.80	gr. 3100 oz. 108.5
	ZN.CC150A4D5P	15	49.20	gr. 4500 oz. 158.5
	ZN.CC200A4D5P	20	65.60	gr. 5900 oz. 206.5

BLACK	Code	Length		Weight
		m	ft	
 M 22ø14 F long fitting ø10 K ø16 With handles	ZN.CC080A4D5Q	8	26.25	gr. 2540 oz. 88.9
	ZN.CC100A4D5Q	10	32.80	gr. 3100 oz. 108.5
	ZN.CC150A4D5Q	15	49.20	gr. 4500 oz. 158.5
	ZN.CC200A4D5Q	20	65.60	gr. 5900 oz. 206.5

BLACK	Code	Length		Weight
		m	ft	
 M 22ø14 F long fitting ø10 K ø18 With handles	ZN.CC080A4D5R	8	26.25	gr. 2540 oz. 88.9
	ZN.CC100A4D5R	10	32.80	gr. 3100 oz. 108.5
	ZN.CC150A4D5R	15	49.20	gr. 4500 oz. 158.5
	ZN.CC200A4D5R	20	65.60	gr. 5900 oz. 206.5

BLACK	Code	Length		Weight
		m	ft	
 M 22ø14 F long fitting ø11 K swivel With handles	ZN.CC080A4D8A	8	26.25	gr. 2540 oz. 88.9
	ZN.CC100A4D8A	10	32.80	gr. 3100 oz. 108.5
	ZN.CC150A4D8A	15	49.20	gr. 4500 oz. 158.5
	ZN.CC200A4D8A	20	65.60	gr. 5900 oz. 206.5

BLACK	Code	Length		Weight
		m	ft	
 M 21ø14 F G 3/8" F With handles	ZN.CC080B4G1Z	8	26.25	gr. 2600 oz. 91.0
	ZN.CC100B4G1Z	10	32.80	gr. 3160 oz. 110.6
	ZN.CC150B4G1Z	15	49.20	gr. 4560 oz. 160.6
	ZN.CC200B4G1Z	20	65.60	gr. 5960 oz. 208.6

BLACK	Code	Length		Weight
		m	ft	
 M 21ø14 F G 3/8" M With handles	ZN.CC080B4G2A	8	26.25	gr. 2600 oz. 91.0
	ZN.CC100B4G2A	10	32.80	gr. 3160 oz. 110.6
	ZN.CC150B4G2A	15	49.20	gr. 4560 oz. 160.6
	ZN.CC200B4G2A	20	65.60	gr. 5960 oz. 208.6

BLACK	Code	Length		Weight
		m	ft	
 M 21ø14 F M 21ø14 F With handles	ZN.CC080B4G4G	8	26.25	gr. 2630 oz. 92.1
	ZN.CC100B4G4G	10	32.80	gr. 3190 oz. 111.7
	ZN.CC150B4G4G	15	49.20	gr. 4590 oz. 161.7
	ZN.CC200B4G4G	20	65.60	gr. 5990 oz. 209.7

BLACK	Code	Length		Weight
		m	ft	
 M 21ø14 F M 22ø14 F With handles	ZN.CC080B4G3P	8	26.25	gr. 2630 oz. 92.1
	ZN.CC100B4G3P	10	32.80	gr. 3190 oz. 111.7
	ZN.CC150B4G3P	15	49.20	gr. 4590 oz. 161.7
	ZN.CC200B4G3P	20	65.60	gr. 5990 oz. 209.7

BLUE	Code	Length		Weight
		m	ft	
 G 3/8" F G 3/8" F With handles	ZB.CC080D1Z1Z	8	26.25	gr. 2540 oz. 88.9
	ZB.CC100D1Z1Z	10	32.80	gr. 3090 oz. 108.2
	ZB.CC150D1Z1Z	15	49.20	gr. 4460 oz. 156.1
	ZB.CC200D1Z1Z	20	65.60	gr. 5840 oz. 204.4

BLUE	Code	Length		Weight
		m	ft	
 G 1/2" F G 1/2" F With handles	ZB.CC080D2B2B	8	26.25	gr. 2590 oz. 90.7
	ZB.CC100D2B2B	10	32.80	gr. 3140 oz. 109.9
	ZB.CC150D2B2B	15	49.20	gr. 4510 oz. 157.9
	ZB.CC200D2B2B	20	65.60	gr. 5890 oz. 206.2

BLUE	Code	Length		Weight
		m	ft	
 1/2" F swivel G 3/8" F With handles	ZB.CC080D2N1Z	8	26.25	gr. 2550 oz. 89.3
	ZB.CC100D2N1Z	10	32.80	gr. 3100 oz. 108.5
	ZB.CC150D2N1Z	15	49.20	gr. 4470 oz. 156.5
	ZB.CC200D2N1Z	20	65.60	gr. 5850 oz. 204.8



H.p. hoses 315 bar(4550 psi) - R1 5/16"

- Pre-assembled

The spare parts branded "CdR" exclusively refer to products by Club dei Riparatori® by IDROBASE®

BLUE	Code	Length		Weight
		m	ft	
	ZB.CC080D2N3P	8	26.25	gr. 2570 oz. 90.0
	ZB.CC100D2N3P	10	32.80	gr. 3120 oz. 109.2
	ZB.CC150D2N3P	15	49.20	gr. 4500 oz. 157.5
	ZB.CC200D2N3P	20	65.60	gr. 5870 oz. 205.5
<i>With handles</i>				

BLUE	Code	Length		Weight
		m	ft	
	ZB.CC080D3P1Z	8	26.25	gr. 2560 oz. 89.6
	ZB.CC100D3P1Z	10	32.80	gr. 3110 oz. 108.9
	ZB.CC150D3P1Z	15	49.20	gr. 4490 oz. 157.2
	ZB.CC200D3P1Z	20	65.60	gr. 5860 oz. 205.1
<i>With handles</i>				

BLUE	Code	Length		Weight
		m	ft	
	ZB.CC080D3P3P	8	26.25	gr. 2590 oz. 90.7
	ZB.CC100D3P3P	10	32.80	gr. 3140 oz. 109.9
	ZB.CC150D3P3P	15	49.20	gr. 4510 oz. 157.9
	ZB.CC200D3P3P	20	65.60	gr. 5890 oz. 206.2
<i>With handles</i>				

BLUE	Code	Length		Weight
		m	ft	
	ZB.CC080D4D1Z	8	26.25	gr. 2570 oz. 90.0
	ZB.CC100D4D1Z	10	32.80	gr. 3120 oz. 109.2
	ZB.CC150D4D1Z	15	49.20	gr. 4500 oz. 157.5
	ZB.CC200D4D1Z	20	65.60	gr. 5870 oz. 205.5
<i>With handles</i>				

BLUE	Code	Length		Weight
		m	ft	
	ZB.CC080D4D3P	8	26.25	gr. 2600 oz. 91.0
	ZB.CC100D4D3P	10	32.80	gr. 3150 oz. 110.3
	ZB.CC150D4D3P	15	49.20	gr. 4520 oz. 158.2
	ZB.CC200D4D3P	20	65.60	gr. 5900 oz. 206.5
<i>With handles</i>				

BLUE	Code	Length		Weight
		m	ft	
	ZB.CC080C4D5P	8	26.25	gr. 2500 oz. 87.5
	ZB.CC100C4D5P	10	32.80	gr. 3050 oz. 106.8
	ZB.CC150C4D5P	15	49.20	gr. 4420 oz. 154.7
	ZB.CC200C4D5P	20	65.60	gr. 5800 oz. 203.0
<i>With handle</i>				

BLUE	Code	Length		Weight
		m	ft	
	ZB.CC080C4D5Q	8	26.25	gr. 2500 oz. 87.5
	ZB.CC100C4D5Q	10	32.80	gr. 3050 oz. 106.8
	ZB.CC150C4D5Q	15	49.20	gr. 4420 oz. 154.7
	ZB.CC200C4D5Q	20	65.60	gr. 5800 oz. 203.0
<i>With handle</i>				

BLUE	Code	Length		Weight
		m	ft	
	ZB.CC080C4D5R	8	26.25	gr. 2500 oz. 87.5
	ZB.CC100C4D5R	10	32.80	gr. 3050 oz. 106.8
	ZB.CC150C4D5R	15	49.20	gr. 4420 oz. 154.7
	ZB.CC200C4D5R	20	65.60	gr. 5800 oz. 203.0
<i>With handle</i>				

BLUE	Code	Length		Weight
		m	ft	
	ZB.CC080C4D8A	8	26.25	gr. 2500 oz. 87.5
	ZB.CC100C4D8A	10	32.80	gr. 3050 oz. 106.8
	ZB.CC150C4D8A	15	49.20	gr. 4420 oz. 154.7
	ZB.CC200C4D8A	20	65.60	gr. 5800 oz. 203.0
<i>With handle</i>				

BLUE	Code	Length		Weight
		m	ft	
	ZB.CC080D4G1Z	8	26.25	gr. 2560 oz. 89.6
	ZB.CC100D4G1Z	10	32.80	gr. 3110 oz. 108.9
	ZB.CC150D4G1Z	15	49.20	gr. 4490 oz. 157.2
	ZB.CC200D4G1Z	20	65.60	gr. 5860 oz. 205.1
<i>With handles</i>				

BLUE	Code	Length		Weight
		m	ft	
	ZB.CC080D4G4G	8	26.25	gr. 2590 oz. 90.7
	ZB.CC100D4G4G	10	32.80	gr. 3140 oz. 109.9
	ZB.CC150D4G4G	15	49.20	gr. 4510 oz. 157.9
	ZB.CC200D4G4G	20	65.60	gr. 5890 oz. 206.2
<i>With handles</i>				

BLUE WITH SS AISI 316 FITTINGS	Code	Length		Weight
		m	ft	
	ZB.CC080D2H2H	8	26.25	gr. 2540 oz. 88.9
	ZB.CC100D2H2H	10	32.80	gr. 3090 oz. 108.2
	ZB.CC150D2H2H	15	49.20	gr. 4460 oz. 156.1
	ZB.CC200D2H2H	20	65.60	gr. 5840 oz. 204.4
<i>With handles</i>				



H.p. hoses 315 bar(4550 psi) - R1 5/16" - Pre-assembled

The spare parts branded "CdR" exclusively refer to products by Club dei Riparatori® by IDROBASE®

BLUE WITH SS AISI 316 FITTINGS

	Code	Length		Weight
		m	ft	
 G 1/2" F	ZB.CC080D2I2I	8	26.25	gr. 2590 oz. 90.7
	ZB.CC100D2I2I	10	32.80	gr. 3140 oz. 109.9
 G 1/2" F	ZB.CC150D2I2I	15	49.20	gr. 4510 oz. 157.9
<i>With handles</i>	ZB.CC200D2I2I	20	65.60	gr. 5890 oz. 206.2

BLUE WITH SS AISI 316 FITTINGS



	Code	Length		Weight
		m	ft	
 M 22ø14 F	ZB.CC080D2L2L	8	26.25	gr. 2660 oz. 93.1
	ZB.CC100D2L2L	10	32.80	gr. 3210 oz. 112.4
 M 22ø14 F	ZB.CC150D2L2L	15	49.20	gr. 4580 oz. 160.3
<i>With handles</i>	ZB.CC200D2L2L	20	65.60	gr. 5960 oz. 208.6



H.p. hoses 400 bar(5800psi) - R2 5/16" - Pre-assembled

The spare parts branded "CdR" exclusively refer to products by Club dei Riparatori® by IDROBASE®

BLACK

	Code	Length		Weight
		m	ft	
 G 3/8" F	ZN.DC080B1Z1Z	8	26.25	gr. 3870 oz. 135.5
	ZN.DC100B1Z1Z	10	32.80	gr. 4750 oz. 166.3
 G 3/8" F	ZN.DC150B1Z1Z	15	49.20	gr. 6950 oz. 243.3
<i>With handles</i>	ZN.DC200B1Z1Z	20	65.60	gr. 9150 oz. 320.3



BLACK

	Code	Length		Weight
		m	ft	
 G 3/8" M	ZN.DC080B2A1Z	8	26.25	gr. 3860 oz. 135.1
	ZN.DC100B2A1Z	10	32.80	gr. 4740 oz. 165.9
 G 3/8" F	ZN.DC150B2A1Z	15	49.20	gr. 6940 oz. 242.9
<i>With handles</i>	ZN.DC200B2A1Z	20	65.60	gr. 9140 oz. 319.9

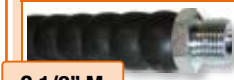

BLACK

	Code	Length		Weight
		m	ft	
 G 1/2" F	ZN.DC080B2B2B	8	26.25	gr. 3920 oz. 137.2
	ZN.DC100B2B2B	10	32.80	gr. 4800 oz. 168.0
 G 1/2" F	ZN.DC150B2B2B	15	49.20	gr. 7000 oz. 245.0
<i>With handles</i>	ZN.DC200B2B2B	20	65.60	gr. 9200 oz. 322.0



BLACK

	Code	Length		Weight
		m	ft	
 G 1/2" M	ZN.DC080B2C2B	8	26.25	gr. 3910 oz. 136.9
	ZN.DC100B2C2B	10	32.80	gr. 4790 oz. 167.7
 G 1/2" F	ZN.DC150B2C2B	15	49.20	gr. 6990 oz. 244.7
<i>With handles</i>	ZN.DC200B2C2B	20	65.60	gr. 9190 oz. 321.7



BLACK

	Code	Length		Weight
		m	ft	
 1/2" F swivel	ZN.DC080B2N1Z	8	26.25	gr. 3880 oz. 135.8
	ZN.DC100B2N1Z	10	32.80	gr. 4760 oz. 166.6
 G 3/8" F	ZN.DC150B2N1Z	15	49.20	gr. 6960 oz. 243.6
<i>With handles</i>	ZN.DC200B2N1Z	20	65.60	gr. 9160 oz. 320.6



BLACK

	Code	Length		Weight
		m	ft	
 1/2" F swivel	ZN.DC080B2N2A	8	26.25	gr. 3870 oz. 135.5
	ZN.DC100B2N2A	10	32.80	gr. 4750 oz. 166.3
 G 3/8" M	ZN.DC150B2N2A	15	49.20	gr. 6950 oz. 243.3
<i>With handles</i>	ZN.DC200B2N2A	20	65.60	gr. 9150 oz. 320.3

BLACK

	Code	Length		Weight
		m	ft	
 1/2" F swivel	ZN.DC080B2N3P	8	26.25	gr. 3900 oz. 136.5
	ZN.DC100B2N3P	10	32.80	gr. 4780 oz. 167.3
 M 22ø14 F	ZN.DC150B2N3P	15	49.20	gr. 6980 oz. 244.3
<i>With handles</i>	ZN.DC200B2N3P	20	65.60	gr. 9180 oz. 321.3

BLACK



	Code	Length		Weight
		m	ft	
 M 22ø14 F	ZN.DC080B3P1Z	8	26.25	gr. 3890 oz. 136.2
	ZN.DC100B3P1Z	10	32.80	gr. 4770 oz. 167.0
 G 3/8" F	ZN.DC150B3P1Z	15	49.20	gr. 6970 oz. 244.0
<i>With handles</i>	ZN.DC200B3P1Z	20	65.60	gr. 9170 oz. 320.3





H.p. hoses 400 bar (5800 psi) - R2 5/16"

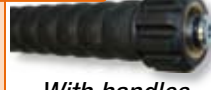

- Pre-assembled

The spare parts branded "CdR" exclusively refer to products by Club dei Riparatori® by IDROBASE®



BLACK		Code	Length		Weight
			m	ft	
 M 22ø14 F G 3/8" M		ZN.DC080B3P2A	8	26.25	gr. 3890 oz. 136.2
		ZN.DC100B3P2A	10	32.80	gr. 4770 oz. 167.0
 With handles		ZN.DC150B3P2A	15	49.20	gr. 6970 oz. 244.0
		ZN.DC200B3P2A	20	65.60	gr. 9170 oz. 320.3



BLACK		Code	Length		Weight
			m	ft	
 M 22ø14 F		ZN.DC080B3P3P	8	26.25	gr. 3920 oz. 137.2
		ZN.DC100B3P3P	10	32.80	gr. 4800 oz. 168.0
 M 22ø14 F With handles		ZN.DC150B3P3P	15	49.20	gr. 7000 oz. 245.0
		ZN.DC200B3P3P	20	65.60	gr. 9200 oz. 322.0



BLACK		Code	Length		Weight
			m	ft	
 M 22ø14 F long G 3/8" F		ZN.DC080B4D1Z	8	26.25	gr. 3900 oz. 136.5
		ZN.DC100B4D1Z	10	32.80	gr. 4780 oz. 167.3
 With handles		ZN.DC150B4D1Z	15	49.20	gr. 6980 oz. 244.3
		ZN.DC200B4D1Z	20	65.60	gr. 9180 oz. 321.3

BLACK		Code	Length		Weight
			m	ft	
 M 22ø14 F long G 3/8" M		ZN.DC080B4D2A	8	26.25	gr. 3900 oz. 136.5
		ZN.DC100B4D2A	10	32.80	gr. 4780 oz. 167.3
 With handles		ZN.DC150B4D2A	15	49.20	gr. 6980 oz. 244.3
		ZN.DC200B4D2A	20	65.60	gr. 9180 oz. 321.3



BLACK		Code	Length		Weight
			m	ft	
 M 22ø14 F long		ZN.DC080B4D3P	8	26.25	gr. 3930 oz. 137.6
		ZN.DC100B4D3P	10	32.80	gr. 4810 oz. 168.4
 M 22ø14 F With handles		ZN.DC150B4D3P	15	49.20	gr. 7010 oz. 245.4
		ZN.DC200B4D3P	20	65.60	gr. 9210 oz. 322.4

BLACK		Code	Length		Weight
			m	ft	
 M 22ø14 F long		ZN.DC080A4D7X	8	26.25	gr. 3830 oz. 134.1
		ZN.DC100A4D7X	10	32.80	gr. 4710 oz. 164.9
 fitting ø10 K ø14 With handle		ZN.DC150A4D7X	15	49.20	gr. 6910 oz. 241.9
		ZN.DC200A4D7X	20	65.60	gr. 9110 oz. 318.9

BLACK		Code	Length		Weight
			m	ft	
 M 22ø14 F long fitting ø10 K ø16		ZN.DC080A4D7Y	8	26.25	gr. 3830 oz. 134.1
		ZN.DC100A4D7Y	10	32.80	gr. 4710 oz. 164.9
 With handle		ZN.DC150A4D7Y	15	49.20	gr. 6910 oz. 241.9
		ZN.DC200A4D7Y	20	65.60	gr. 9110 oz. 318.9

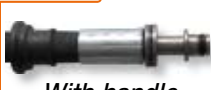
BLACK		Code	Length		Weight
			m	ft	
 M 22ø14 F long fitting ø10 K ø18		ZN.DC080A4D7Z	8	26.25	gr. 3840 oz. 134.4
		ZN.DC100A4D7Z	10	32.80	gr. 4720 oz. 165.2
 With handle		ZN.DC150A4D7Z	15	49.20	gr. 6920 oz. 242.2
		ZN.DC200A4D7Z	20	65.60	gr. 9120 oz. 319.2

BLACK		Code	Length		Weight
			m	ft	
 M 22ø14 F long fitting ø11 K swivel		ZN.DC080A4D5S	8	26.25	gr. 3840 oz. 134.4
		ZN.DC100A4D5S	10	32.80	gr. 4720 oz. 165.2
 With handle		ZN.DC150A4D5S	15	49.20	gr. 6920 oz. 242.2
		ZN.DC200A4D5S	20	65.60	gr. 9120 oz. 319.2



BLACK		Code	Length		Weight
			m	ft	
 M 21ø14 F G 3/8" F		ZN.DC080B4G1Z	8	26.25	gr. 3890 oz. 136.2
		ZN.DC100B4G1Z	10	32.80	gr. 4770 oz. 167.0
 With handles		ZN.DC150B4G1Z	15	49.20	gr. 6970 oz. 244.0
		ZN.DC200B4G1Z	20	65.60	gr. 9170 oz. 320.3





H.p. hoses 400 bar (5800 psi) - R2 5/16"

- Pre-assembled

The spare parts branded "CdR" exclusively refer to products by Club dei Riparatori® by IDROBASE®

BLACK	Code	Length		Weight
		m	ft	
	ZN.DC080B4G2A	8	26.25	gr. 3890 oz. 136.2
	ZN.DC100B4G2A	10	32.80	gr. 4770 oz. 167.0
	ZN.DC150B4G2A	15	49.20	gr. 6970 oz. 244.0
	ZN.DC200B4G2A	20	65.60	gr. 9170 oz. 320.3



M 22ø14 F
G 3/8" M
With handles

BLACK	Code	Length		Weight
		m	ft	
	ZN.DC080B4G4G	8	26.25	gr. 3920 oz. 137.2
	ZN.DC100B4G4G	10	32.80	gr. 4800 oz. 168.0
	ZN.DC150B4G4G	15	49.20	gr. 7000 oz. 245.0
	ZN.DC200B4G4G	20	65.60	gr. 9200 oz. 322.0



M 21ø14 F
M 21ø14 F
With handles

BLACK	Code	Length		Weight
		m	ft	
	ZN.DC080B4G3P	8	26.25	gr. 3920 oz. 137.2
	ZN.DC100B4G3P	10	32.80	gr. 4800 oz. 168.0
	ZN.DC150B4G3P	15	49.20	gr. 7000 oz. 245.0
	ZN.DC200B4G3P	20	65.60	gr. 9200 oz. 322.0



M 21ø14 F
M 22ø14 F
With handles

BLUE	Code	Length		Weight
		m	ft	
	ZB.DC080D1Z1Z	8	26.25	gr. 3990 oz. 139.7
	ZB.DC100D1Z1Z	10	32.80	gr. 4900 oz. 171.5
	ZB.DC150D1Z1Z	15	49.20	gr. 7170 oz. 251.0
	ZB.DC200D1Z1Z	20	65.60	gr. 9450 oz. 330.8



G 3/8" F
G 3/8" F
With handles

BLUE	Code	Length		Weight
		m	ft	
	ZB.DC080D2B2B	8	26.25	gr. 4040 oz. 141.4
	ZB.DC100D2B2B	10	32.80	gr. 4950 oz. 173.3
	ZB.DC150D2B2B	15	49.20	gr. 7220 oz. 252.7
	ZB.DC200D2B2B	20	65.60	gr. 9500 oz. 332.5



G 1/2" F
G 1/2" F
With handles

BLUE	Code	Length		Weight
		m	ft	
	ZB.DC080D2N1Z	8	26.25	gr. 4000 oz. 140.0
	ZB.DC100D2N1Z	10	32.80	gr. 4910 oz. 171.9
	ZB.DC150D2N1Z	15	49.20	gr. 7180 oz. 251.3
	ZB.DC200D2N1Z	20	65.60	gr. 9460 oz. 331.1

1/2" F swivel
G 3/8" F
With handles

BLUE	Code	Length		Weight
		m	ft	
	ZB.DC080D2N3P	8	26.25	gr. 4020 oz. 140.7
	ZB.DC100D2N3P	10	32.80	gr. 4930 oz. 172.6
	ZB.DC150D2N3P	15	49.20	gr. 7210 oz. 252.4
	ZB.DC200D2N3P	20	65.60	gr. 9480 oz. 331.8



1/2" F swivel
M 22ø14 F
With handles

BLUE	Code	Length		Weight
		m	ft	
	ZB.DC080D3P1Z	8	26.25	gr. 4010 oz. 140.4
	ZB.DC100D3P1Z	10	32.80	gr. 4920 oz. 172.2
	ZB.DC150D3P1Z	15	49.20	gr. 7200 oz. 252.0
	ZB.DC200D3P1Z	20	65.60	gr. 9470 oz. 331.5

M 22ø14 F
G 3/8" F
With handles

BLUE	Code	Length		Weight
		m	ft	
	ZB.DC080D3P3P	8	26.25	gr. 4040 oz. 141.4
	ZB.DC100D3P3P	10	32.80	gr. 4950 oz. 173.3
	ZB.DC150D3P3P	15	49.20	gr. 7220 oz. 252.7
	ZB.DC200D3P3P	20	65.60	gr. 9500 oz. 332.5

M 22ø14 F
M 22ø14 F
With handles

BLUE	Code	Length		Weight
		m	ft	
	ZB.DC080D4D1Z	8	26.25	gr. 4020 oz. 140.7
	ZB.DC100D4D1Z	10	32.80	gr. 4930 oz. 172.6
	ZB.DC150D4D1Z	15	49.20	gr. 7210 oz. 252.4
	ZB.DC200D4D1Z	20	65.60	gr. 9480 oz. 331.8



M 22ø14 F long
G 3/8" F
With handles



H.p. hoses 400 bar (5800 psi) - R2 5/16"

- Pre-assembled



The spare parts branded "CdR" exclusively refer to products by Club dei Riparatori® by IDROBASE®

BLUE	Code	Length		Weight
		m	ft	
	ZB.DC080D4D3P	8	26.25	gr. 4050 oz. 141.8
	ZB.DC100D4D3P	10	32.80	gr. 4960 oz. 173.6
	ZB.DC150D4D3P	15	49.20	gr. 7230 oz. 253.1
	ZB.DC200D4D3P	20	65.60	gr. 9510 oz. 323.4

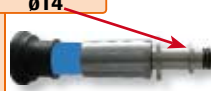
M 22ø14 F long
M 22ø14 F
With handles

BLUE	Code	Length		Weight
		m	ft	
	ZB.DC080C4D7X	8	26.25	gr. 3910 oz. 136.9
	ZB.DC100C4D7X	10	32.80	gr. 4820 oz. 168.7
	ZB.DC150C4D7X	15	49.20	gr. 7090 oz. 248.2
	ZB.DC200C4D7X	20	65.60	gr. 9370 oz. 328.0



M 22ø14 F long
fitting ø10 K ø14
With handle

BLUE	Code	Length		Weight
		m	ft	
	ZB.DC080C4D7Y	8	26.25	gr. 3910 oz. 136.9
	ZB.DC100C4D7Y	10	32.80	gr. 4820 oz. 168.7
	ZB.DC150C4D7Y	15	49.20	gr. 7090 oz. 248.2
	ZB.DC200C4D7Y	20	65.60	gr. 9370 oz. 328.0

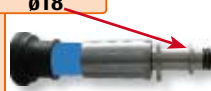

M 22ø14 F long
fitting ø10 K ø16
With handle

BLUE	Code	Length		Weight
		m	ft	
	ZB.DC080C4D7Z	8	26.25	gr. 3920 oz. 137.2
	ZB.DC100C4D7Z	10	32.80	gr. 4830 oz. 169.1
	ZB.DC150C4D7Z	15	49.20	gr. 7100 oz. 248.5
	ZB.DC200C4D7Z	20	65.60	gr. 9380 oz. 328.3



M 22ø14 F long
fitting ø10 K ø18
With handle

BLUE	Code	Length		Weight
		m	ft	
	ZB.DC080C4D5S	8	26.25	gr. 3920 oz. 137.2
	ZB.DC100C4D5S	10	32.80	gr. 4830 oz. 169.1
	ZB.DC150C4D5S	15	49.20	gr. 7100 oz. 248.5
	ZB.DC200C4D5S	20	65.60	gr. 9380 oz. 328.3



M 22ø14 F long
fitting ø11 K swivel
With handle

BLUE	Code	Length		Weight
		m	ft	
	ZB.DC080D4G1Z	8	26.25	gr. 4010 oz. 140.4
	ZB.DC100D4G1Z	10	32.80	gr. 4920 oz. 172.2
	ZB.DC150D4G1Z	15	49.20	gr. 7200 oz. 252.0
	ZB.DC200D4G1Z	20	65.60	gr. 9470 oz. 331.5



M 21ø14 F
G 3/8" F
With handles

BLUE	Code	Length		Weight
		m	ft	
	ZB.DC080D4G4G	8	26.25	gr. 4040 oz. 141.4
	ZB.DC100D4G4G	10	32.80	gr. 4950 oz. 173.3
	ZB.DC150D4G4G	15	49.20	gr. 7220 oz. 252.7
	ZB.DC200D4G4G	20	65.60	gr. 9500 oz. 332.5



M 21ø14 F
M 21ø14 F
With handles

BLUE WITH SS AISI 316 FITTINGS	Code	Length		Weight
		m	ft	
	ZB.DC080D2H2H	8	26.25	gr. 3990 oz. 139.7
	ZB.DC100D2H2H	10	32.80	gr. 4900 oz. 171.5
	ZB.DC150D2H2H	15	49.20	gr. 7170 oz. 251.0
	ZB.DC200D2H2H	20	65.60	gr. 9450 oz. 330.8

G 3/8" F
G 3/8" F
With handles

BLUE WITH SS AISI 316 FITTINGS	Code	Length		Weight
		m	ft	
	ZB.DC080D2I2I	8	26.25	gr. 4040 oz. 141.4
	ZB.DC100D2I2I	10	32.80	gr. 4950 oz. 173.3
	ZB.DC150D2I2I	15	49.20	gr. 7220 oz. 252.7
	ZB.DC200D2I2I	20	65.60	gr. 9500 oz. 332.5

G 1/2" F
G 1/2" F
With handles

BLUE WITH SS AISI 316 FITTINGS	Code	Length		Weight
		m	ft	
	ZB.DC080D2L2L	8	26.25	gr. 4110 oz. 143.9
	ZB.DC100D2L2L	10	32.80	gr. 5020 oz. 175.7
	ZB.DC150D2L2L	15	49.20	gr. 7290 oz. 255.2
	ZB.DC200D2L2L	20	65.60	gr. 9570 oz. 335.0

M 22ø14 F
M 22ø14 F
With handles



H.p. hoses 400 bar (5800 psi) - R2 3/8"

- Pre-assembled

The spare parts branded "CdR" exclusively refer to products by Club dei Riparatori® by IDROBASE®

BLACK	Code	Length m ft	Weight
	ZN.EC100B2D2D	10 32.80	gr. 5950 oz. 208.3
G 3/8" F			
	ZN.EC150B2D2D	15 49.20	gr. 8750 oz. 306.3
G 3/8" F			
	ZN.EC200B2D2D	20 65.60	gr. 11550 oz. 404.3
<i>With handles</i>			

BLACK	Code	Length m ft	Weight
	ZN.EC100B2E2D	10 32.80	gr. 5940 oz. 207.9
G 3/8" M			
	ZN.EC150B2E2D	15 49.20	gr. 8740 oz. 305.9
G 3/8" F			
	ZN.EC200B2E2D	20 65.60	gr. 11540 oz. 403.9
<i>With handles</i>			

BLACK	Code	Length m ft	Weight
	ZN.EC100B2F2F	10 32.80	gr. 6000 oz. 210.0
G 1/2" F			
	ZN.EC150B2F2F	15 49.20	gr. 8800 oz. 308.0
G 1/2" F			
	ZN.EC200B2F2F	20 65.60	gr. 11600 oz. 406.0
<i>With handles</i>			

BLACK	Code	Length m ft	Weight
	ZN.EC100B2G2F	10 32.80	gr. 5990 oz. 209.7
G 1/2" M			
	ZN.EC150B2G2F	15 49.20	gr. 8790 oz. 307.7
G 1/2" F			
	ZN.EC200B2G2F	20 65.60	gr. 11590 oz. 405.7
<i>With handles</i>			

BLACK	Code	Length m ft	Weight
	ZN.EC100B2O2D	10 32.80	gr. 5960 oz. 208.6
1/2" F swivel			
	ZN.EC150B2O2D	15 49.20	gr. 8760 oz. 306.6
G 3/8" F			
	ZN.EC200B2O2D	20 65.60	gr. 11560 oz. 404.6
<i>With handles</i>			

BLACK	Code	Length m ft	Weight
	ZN.EC100B2O2E	10 32.80	gr. 5950 oz. 208.3
1/2" F swivel			
	ZN.EC150B2O2E	15 49.20	gr. 8750 oz. 306.3
G 3/8" M			
	ZN.EC200B2O2E	20 65.60	gr. 11550 oz. 404.3
<i>With handles</i>			

BLACK	Code	Length m ft	Weight
	ZN.EC100B2O2F	10 32.80	gr. 5980 oz. 209.3
1/2" F swivel			
	ZN.EC150B2O2F	15 49.20	gr. 8780 oz. 307.3
G 1/2" F			
	ZN.EC200B2O2F	20 65.60	gr. 11580 oz. 405.3
<i>With handles</i>			

BLACK	Code	Length m ft	Weight
	ZN.EC100B2O2G	10 32.80	gr. 5980 oz. 209.3
1/2" F swivel			
	ZN.EC150B2O2G	15 49.20	gr. 8780 oz. 307.3
G 1/2" M			
	ZN.EC200B2O2G	20 65.60	gr. 11580 oz. 405.3
<i>With handles</i>			

BLACK	Code	Length m ft	Weight
	ZN.EC100B2O4N	10 32.80	gr. 5980 oz. 209.3
1/2" F swivel			
	ZN.EC150B2O4N	15 49.20	gr. 8780 oz. 307.3
M 22ø14 F			
	ZN.EC200B2O4N	20 65.60	gr. 11580 oz. 405.3
<i>With handles</i>			



BLACK	Code	Length m ft	Weight
	ZN.EC100B4N2D	10 32.80	gr. 5970 oz. 209.0
M 22ø14 F			
	ZN.EC150B4N2D	15 49.20	gr. 8770 oz. 307.0
G 3/8" F			
	ZN.EC200B4N2D	20 65.60	gr. 11570 oz. 405.0
<i>With handles</i>			



H.p. hoses 400 bar (5800 psi) - R2 3/8"

- Pre-assembled



The spare parts branded "CdR" exclusively refer to products by Club dei Riparatori® by IDROBASE®

BLACK	Code	Length		Weight
		m	ft	
	ZN.EC100B4N2E	10	32.80	gr. 5970 oz. 209.0
	ZN.EC150B4N2E	15	49.20	gr. 8770 oz. 307.0
	ZN.EC200B4N2E	20	65.60	gr. 11570 oz. 405.0

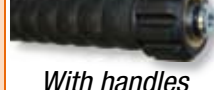

With handles

BLACK	Code	Length		Weight
		m	ft	
	ZN.EC100B4N4N	10	32.80	gr. 6000 oz. 210.0
	ZN.EC150B4N4N	15	49.20	gr. 8800 oz. 308.0
	ZN.EC200B4N4N	20	65.60	gr. 11600 oz. 406.0



With handles

BLACK	Code	Length		Weight
		m	ft	
	ZN.EC100B5B2D	10	32.80	gr. 5980 oz. 209.3
	ZN.EC150B5B2D	15	49.20	gr. 8780 oz. 307.3
	ZN.EC200B5B2D	20	65.60	gr. 11580 oz. 405.3



With handles

BLACK	Code	Length		Weight
		m	ft	
	ZN.EC100B5B2E	10	32.80	gr. 5980 oz. 209.3
	ZN.EC150B5B2E	15	49.20	gr. 8780 oz. 307.3
	ZN.EC200B5B2E	20	65.60	gr. 11580 oz. 405.3



With handles

BLACK	Code	Length		Weight
		m	ft	
	ZN.EC100B5B4N	10	32.80	gr. 6010 oz. 210.4
	ZN.EC150B5B4N	15	49.20	gr. 8810 oz. 308.4
	ZN.EC200B5B4N	20	65.60	gr. 11610 oz. 406.4



With handles

BLACK	Code	Length		Weight
		m	ft	
	ZN.EC100B5F2D	10	32.80	gr. 5970 oz. 209.0
	ZN.EC150B5F2D	15	49.20	gr. 8770 oz. 307.0
	ZN.EC200B5F2D	20	65.60	gr. 11570 oz. 405.0



With handles

BLACK	Code	Length		Weight
		m	ft	
	ZN.EC100B5F2E	10	32.80	gr. 5970 oz. 209.0
	ZN.EC150B5F2E	15	49.20	gr. 8770 oz. 307.0
	ZN.EC200B5F2E	20	65.60	gr. 11570 oz. 405.0



With handles

BLACK	Code	Length		Weight
		m	ft	
	ZN.EC100B5F5F	10	32.80	gr. 6000 oz. 210.0
	ZN.EC150B5F5F	15	49.20	gr. 8800 oz. 308.0
	ZN.EC200B5F5F	20	65.60	gr. 11600 oz. 406.0

With handles

BLUE	Code	Length		Weight
		m	ft	
	ZB.EC100D2D2D	10	32.80	gr. 6050 oz. 211.8
	ZB.EC150D2D2D	15	49.20	gr. 8900 oz. 311.5
	ZB.EC200D2D2D	20	65.60	gr. 11750 oz. 411.3

With handles



BLUE	Code	Length		Weight
		m	ft	
	ZB.EC100D2F2F	10	32.80	gr. 6100 oz. 213.5
	ZB.EC150D2F2F	15	49.20	gr. 8950 oz. 313.3
	ZB.EC200D2F2F	20	65.60	gr. 11800 oz. 413.0



With handles





H.p. hoses 400 bar (5800 psi) - R2 3/8" - Pre-assembled

The spare parts branded "CdR" exclusively refer to products by Club dei Riparatori® by IDROBASE®



BLUE	Code	Length		Weight
		m	ft	
	ZB.EC100D202D	10	32.80	gr. 6090 oz. 213.2
	ZB.EC150D202D	15	49.20	gr. 8940 oz. 312.9
	ZB.EC200D202D	20	65.60	gr. 11790 oz. 412.7



BLUE	Code	Length		Weight
		m	ft	
	ZB.EC100D202F	10	32.80	gr. 6080 oz. 212.8
	ZB.EC150D202F	15	49.20	gr. 8930 oz. 312.6
	ZB.EC200D202F	20	65.60	gr. 11780 oz. 412.3

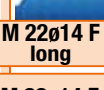

BLUE	Code	Length		Weight
		m	ft	
	ZB.EC100D4N2D	10	32.80	gr. 6070 oz. 212.5
	ZB.EC150D4N2D	15	49.20	gr. 8920 oz. 312.2
	ZB.EC200D4N2D	20	65.60	gr. 11770 oz. 412.0

BLUE	Code	Length		Weight
		m	ft	
	ZB.EC100D4N4N	10	32.80	gr. 6100 oz. 213.5
	ZB.EC150D4N4N	15	49.20	gr. 8950 oz. 313.3
	ZB.EC200D4N4N	20	65.60	gr. 11800 oz. 413.0

BLUE	Code	Length		Weight
		m	ft	
	ZB.EC100D5B2D	10	32.80	gr. 6080 oz. 212.8
	ZB.EC150D5B2D	15	49.20	gr. 8930 oz. 312.6
	ZB.EC200D5B2D	20	65.60	gr. 11780 oz. 412.3

BLUE	Code	Length		Weight
		m	ft	
	ZB.EC100D5B4N	10	32.80	gr. 6110 oz. 213.9
	ZB.EC150D5B4N	15	49.20	gr. 8960 oz. 313.6
	ZB.EC200D5B4N	20	65.60	gr. 11810 oz. 413.4

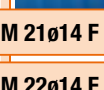
BLUE	Code	Length		Weight
		m	ft	
	ZB.EC100D5F2D	10	32.80	gr. 6070 oz. 212.5
	ZB.EC150D5F2D	15	49.20	gr. 8920 oz. 312.2
	ZB.EC200D5F2D	20	65.60	gr. 11770 oz. 412.0

BLUE	Code	Length		Weight
		m	ft	
	ZB.EC100D5F4N	10	32.80	gr. 6100 oz. 213.5
	ZB.EC150D5F4N	15	49.20	gr. 8950 oz. 313.3
	ZB.EC200D5F4N	20	65.60	gr. 11800 oz. 413.0

BLUE WITH SS AISI 316 FITTINGS	Code	Length		Weight
		m	ft	
	ZB.EC100D2J2J	10	32.80	gr. 6050 oz. 211.8
	ZB.EC150D2J2J	15	49.20	gr. 8900 oz. 311.5
	ZB.EC200D2J2J	20	65.60	gr. 11750 oz. 411.3

BLUE WITH SS AISI 316 FITTINGS	Code	Length		Weight
		m	ft	
	ZB.EC100D2K2K	10	32.80	gr. 6100 oz. 213.5
	ZB.EC150D2K2K	15	49.20	gr. 8950 oz. 313.3
	ZB.EC200D2K2K	20	65.60	gr. 11800 oz. 413.0

BLUE WITH SS AISI 316 FITTINGS	Code	Length		Weight
		m	ft	
	ZB.EC100D2V2V	10	32.80	gr. 6100 oz. 213.5
	ZB.EC150D2V2V	15	49.20	gr. 8950 oz. 313.3
	ZB.EC200D2V2V	20	65.60	gr. 11800 oz. 413.0

High pressure hoses showed in these pages are a selected range of products guaranteed by

Club dei Riparatori®



Do not be misled by the price!



The quality of Club dei Riparatori® high pressure hoses is the best and the price is so tempting just because we sell them without agents.







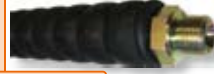

H.p. hoses 500 bar(7250 psi) - R2 3/8"
- Pre-assembled

The spare parts branded "CdR" exclusively refer to products by Club dei Riparatori® by IDROBASE®

BLACK	Code	Length		Weight
		m	ft	
	ZN.FC100B2D2D	10	32.80	gr. 5200 oz. 182.0
G 3/8" F				
	ZN.FC150B2D2D	15	49.20	gr. 7620 oz. 266.7
G 3/8" F				
 <i>With handles</i>	ZN.FC200B2D2D	20	65.60	gr. 10050 oz. 351.8

BLACK	Code	Length		Weight
		m	ft	
	ZN.FC100B2E2D	10	32.80	gr. 5190 oz. 181.7
G 3/8" M				
	ZN.FC150B2E2D	15	49.20	gr. 7620 oz. 266.7
G 3/8" F				
 <i>With handles</i>	ZN.FC200B2E2D	20	65.60	gr. 10040 oz. 351.4

BLACK	Code	Length		Weight
		m	ft	
	ZN.FC100B2F2F	10	32.80	gr. 5250 oz. 183.8
G 1/2" F				
	ZN.FC150B2F2F	15	49.20	gr. 7670 oz. 268.5
G 1/2" F				
 <i>With handles</i>	ZN.FC200B2F2F	20	65.60	gr. 10100 oz. 353.5

BLACK	Code	Length		Weight
		m	ft	
	ZN.FC100B2G2F	10	32.80	gr. 5250 oz. 183.8
G 1/2" M				
	ZN.FC150B2G2F	15	49.20	gr. 7670 oz. 268.5
G 1/2" F				
 <i>With handles</i>	ZN.FC200B2G2F	20	65.60	gr. 10100 oz. 353.5



High pressure hoses - R1 1/4" and fittings

The spare parts branded "CdR" exclusively refer to products by Club dei Riparatori® by IDROBASE®

R1 1/4" BLACK 210 bar-3050 psi



Code	Length		Weight
	m	ft	
ZN.AC080	8	26.25	gr. 1480 oz. 51.8
ZN.AC100	10	32.80	gr. 1850 oz. 64.8
ZN.AC150	15	49.20	gr. 2770 oz. 97.0
ZN.AC200	20	65.60	gr. 3700 oz. 129.5
ZN.AC500	50	164.00	gr. 9200 oz. 322.0

Only h.p. hose

Club dei Riparatori®



The winning solution to manufacture and repair all kinds of pressure washers

FITTINGS

	Code	Description	Weight
	CDR.1A	Black handle	gr. 40 oz. 1.4
	CDR.1C	Blue handle	gr. 40 oz. 1.4
	CDR.1B	Yellow handle	gr. 40 oz. 1.4
	CDR.5V	Crimped ferrule	gr. 25 oz. 0.9
	CDR.1R	Crimped G 1/4" F	gr. 30 oz. 1.1
	CDR.1S	Crimped G 1/4" M	gr. 25 oz. 0.9
	CDR.1T	Crimped G 3/8" F	gr. 40 oz. 1.4
	CDR.1U	Crimped G 3/8" M	gr. 40 oz. 1.4
	CDR.1V	Crimped G 1/2" F	gr. 70 oz. 2.5
	CDR.1W	Crimped G 1/2" M	gr. 60 oz. 2.1
	CDR.6F	GREEN ring nut for 1/2" F crimped fitting MV	gr. 30 oz. 1.1



FITTINGS















	Code	Description	Weight
	CDR.6J	BLACK ring nut for M22x1,5 F ø14 crimped	gr. 35 oz. 1.3
	CDR.6K	BLACK "LONG" ring nut for M22x1,5 F ø14 crimped	gr. 45 oz. 1.6
	CDR.6L	HEXAGON nut for M22x1,5 F ø14 crimped STAINLESS STEEL AISI 316	gr. 75 oz. 2.7
	CDR.6M	YELLOW ring nut for M22x1,5 F ø14 crimped	gr. 30 oz. 1.1
	CDR.6N	BLUE ring nut for M21x1,5 F ø14 crimped	gr. 30 oz. 1.1
	CDR.6O	DARK BLUE ring nut for M22x1,5 F ø15 crimped	gr. 35 oz. 1.3
	CDR.6G	Insert for crimped fitting 1/2" F fitting MV	gr. 25 oz. 0.9
	CDR.6P	Insert ø14	gr. 35 oz. 1.3
	CDR.6Q	Insert ø14, 75°	gr. 45 oz. 1.6
	CDR.6R	Insert ø14, 90°	gr. 45 oz. 1.6
	CDR.6S	Insert ø14, neck 5 mm - ROUNDED	gr. 40 oz. 1.4



High pressure hoses - R1 1/4" and fittings

The spare parts branded "CdR" exclusively refer to products by Club dei Riparatori® by IDROBASE®

FITTINGS	Code	Description	Weight
	CDR.7S	Insert $\phi 14$, neck 14 mm - ROUNDED	gr. 45 oz. 1.6
	CDR.6U	Insert $\phi 14$, 75° - ROUNDED	gr. 45 oz. 1.6
	CDR.6V	Insert $\phi 14$, 90° - ROUNDED	gr. 45 oz. 1.6
	CDR.7M	Insert $\phi 15$	gr. 35 oz. 1.3
	ZX.2M	Crimped 1/2" F fitting MV with GREEN ring nut	gr. 55 oz. 2.0
	ZX.50	Crimped $\phi 10$ fitting K with crimped ferrule	gr. 60 oz. 2.1
	ZX.3H	Crimped M21x1,5 F $\phi 14$ with BLUE ring nut	gr. 65 oz. 2.3
	ZX.3I	Crimped M21x1,5 F $\phi 14$ 75° with BLUE ring nut	gr. 75 oz. 2.7
	ZX.3J	Crimped M21x1,5 F $\phi 14$ 90° with BLUE ring nut	gr. 75 oz. 2.7
	ZX.3L	Crimped M21x1,5 F $\phi 14$ neck 5 mm - ROUNDED with BLUE ring nut	gr. 65 oz. 2.3
	ZX.3M	Crimped M21x1,5 F $\phi 14$ neck 14 mm - ROUNDED with BLUE ring nut	gr. 70 oz. 2.5
	ZX.2P	Crimped M22x1,5 F $\phi 14$ with BLACK ring nut	gr. 70 oz. 2.5
	ZX.2Q	Crimped M22x1,5 F $\phi 14$ 75° with BLACK ring nut	gr. 80 oz. 2.8
	ZX.2R	Crimped M22x1,5 F $\phi 14$ 90° with BLACK ring nut	gr. 80 oz. 2.8
	ZX.2S	Crimped M22x1,5 F $\phi 14$ neck 5 mm - ROUNDED with BLACK ring nut	gr. 70 oz. 2.5
	ZX.2T	Crimped M22x1,5 F $\phi 14$ neck 14 mm - ROUNDED with BLACK ring nut	gr. 75 oz. 2.7

FITTINGS	Code	Description	Weight
	ZX.2U	Crimped M22x1,5 F $\phi 14$ 75° - ROUNDED with BLACK ring nut	gr. 80 oz. 2.8
	ZX.2W	Crimped M22x1,5 F $\phi 14$ 90° - ROUNDED with BLACK ring nut	gr. 80 oz. 2.8
	ZX.3E	Crimped M22x1,5 F $\phi 14$ with BLACK "LONG" ring nut	gr. 80 oz. 2.8
	ZX.3F	Crimped M22x1,5 F $\phi 14$ neck 5 mm - ROUNDED w/ BLACK "LONG" ring nut	gr. 85 oz. 3.0
	ZX.3G	Crimped M22x1,5 F $\phi 14$ neck 14 mm - ROUNDED w/ BLACK "LONG" ring nut	gr. 85 oz. 3.0
	ZX.2X	Crimped M22x1,5 F $\phi 14$ with YELLOW ring nut	gr. 65 oz. 2.1
	ZX.2Y	Crimped M22x1,5 F $\phi 14$ 75° with YELLOW ring nut	gr. 75 oz. 2.7
	ZX.2Z	Crimped M22x1,5 F $\phi 14$ 90° with YELLOW ring nut	gr. 75 oz. 2.7
	ZX.3A	Crimped M22x1,5 F $\phi 14$ neck 5 mm - ROUNDED with YELLOW ring nut	gr. 65 oz. 2.3
	ZX.3B	Crimped M22x1,5 F $\phi 14$ neck 14 mm - ROUNDED with YELLOW ring nut	gr. 70 oz. 2.5
	ZX.3C	Crimped M22x1,5 F $\phi 14$ 75° - ROUNDED with YELLOW ring nut	gr. 75 oz. 2.7
	ZX.3D	Crimped M22x1,5 F $\phi 14$ 90° - ROUNDED with YELLOW ring nut	gr. 75 oz. 2.7
	ZX.5M	Crimped M22x1,5 F $\phi 15$ with DARK BLUE ring nut	gr. 75 oz. 2.7
	CDR.70	Crimped fitting HOSE CONNECTION	gr. 100 oz. 3.5



High pressure hoses - R1 and R2 5/16" and fittings

The spare parts branded "CdR" exclusively refer to products by Club dei Riparatori® by IDROBASE®

R1 5/16" BLACK 315 bar-4550 psi



Only h.p. hose

Code	Length		Weight
	m	ft	
ZN.CC080	8	26.25	gr. 2240 oz. 78.4
ZN.CC100	10	32.80	gr. 2800 oz. 98.0
ZN.CC150	15	49.20	gr. 4200 oz. 147.0
ZN.CC200	20	65.60	gr. 5600 oz. 197.4
ZN.CC500	50	164.00	gr. 14000 oz. 490.0

R1 5/16" BLUE 315 bar-4550 psi



Only h.p. hose

Code	Length		Weight
	m	ft	
ZB.CC080	8	26.25	gr. 2200 oz. 77.0
ZB.CC100	10	32.80	gr. 2750 oz. 96.3
ZB.CC150	15	49.20	gr. 4120 oz. 144.2
ZB.CC200	20	65.60	gr. 5500 oz. 192.5
ZB.CC500	50	164.00	gr. 13700 oz. 479.5

R2 5/16" BLACK 400 bar-5800 psi



Only h.p. hose

Code	Length		Weight
	m	ft	
ZN.DC080	8	26.25	gr. 3520 oz. 119.7
ZN.DC100	10	32.80	gr. 4400 oz. 154.0
ZN.DC150	15	49.20	gr. 6600 oz. 231.0
ZN.DC200	20	65.60	gr. 8800 oz. 308.0
ZN.DC500	50	164.00	gr. 22000 oz. 770.0

R2 5/16" BLUE 400 bar-580 psi



Only h.p. hose

Code	Length		Weight
	m	ft	
ZB.DC080	8	26.25	gr. 3640 oz. 127.4
ZB.DC100	10	32.80	gr. 4550 oz. 159.3
ZB.DC150	15	49.20	gr. 6820 oz. 238.7
ZB.DC200	20	65.60	gr. 9100 oz. 318.5
ZB.DC500	50	164.00	gr. 22700 oz. 794.5

FITTINGS

	Code	Description	Weight
	CDR.1D	R1 Black handle	gr. 80 oz. 2.8
	CDR.1F	R1 Blue handle	gr. 80 oz. 2.8
	CDR.1E	R1 Yellow handle	gr. 80 oz. 2.8
	CDR.1G	R2 Black handle	gr. 80 oz. 2.8
	CDR.1I	R2 Blue handle	gr. 80 oz. 2.8
	CDR.1H	R2 Yellow handle	gr. 80 oz. 2.8
	CDR.5W	R1 Crimped ferrule	gr. 40 oz. 1.4
	CDR.5X	R1 crimped ferrule STAINLESS STEEL AISI 316	gr. 40 oz. 1.4
	CDR.5Y	R2 Crimped ferrule	gr. 45 oz. 1.6
	CDR.5Z	R2 crimped ferrule STAINLESS STEEL AISI 316	gr. 45 oz. 1.6
	CDR.1X	Crimped G 1/4" F	gr. 40 oz. 1.4
	CDR.1Y	Crimped G 1/4" M	gr. 40 oz. 1.4
	CDR.1Z	Crimped G 3/8" F	gr. 50 oz. 1.8
	CDR.2A	Crimped G 3/8" M	gr. 45 oz. 1.6

FITTINGS

	Code	Description	Weight
	CDR.2H	Crimped G 3/8" F STAINLESS STEEL AISI 316	gr. 50 oz. 1.8
	CDR.2B	Crimped G 1/2" F	gr. 75 oz. 2.7
	CDR.2C	Crimped G 1/2" M	gr. 70 oz. 2.5
	CDR.2I	Crimped G 1/2" F STAINLESS STEEL AISI 316	gr. 75 oz. 2.7
	CDR.6F	GREEN ring nut for 1/2" F crimped fitting MV	gr. 30 oz. 1.1
	CDR.6J	BLACK ring nut for M22x1,5 F ø14 crimped	gr. 35 oz. 1.3
	CDR.6K	BLACK "LONG" ring nut for M22x1,5 F ø14 crimped	gr. 45 oz. 1.6
	CDR.6L	HEXAGON nut for M22x1,5 F ø14 crimped STAINLESS STEEL	gr. 75 oz. 2.7
	CDR.6M	YELLOW ring nut for M22x1,5 F ø14 crimped	gr. 30 oz. 1.1
	CDR.6N	BLUE ring nut for M21x1,5 F ø14 crimped	gr. 30 oz. 1.1
	CDR.6O	DARK BLUE ring nut for M22x1,5 F ø15 crimped	gr. 35 oz. 1.3
	CDR.6H	Insert for crimped fitting 1/2" F fitting MV	gr. 30 oz. 1.1
	CDR.6W	Insert ø14	gr. 40 oz. 1.4
	CDR.6X	Insert ø14 STAINLESS STEEL AISI 316	gr. 40 oz. 1.4



High pressure hoses - R1 and R2 5/16" and fittings

The spare parts branded "CdR" exclusively refer to products by Club dei Riparatori® by IDROBASE®

FITTINGS	Code	Description	Weight
	CDR.6T	Insert $\phi 14$, 75°	gr. 50 oz. 1.8
	CDR.6Z	Insert $\phi 14$, 90°	gr. 50 oz. 1.8
	CDR.7A	Insert $\phi 14$, neck 5 mm - ROUNDED	gr. 40 oz. 1.4
	CDR.7B	Insert $\phi 14$, neck 14 mm - ROUNDED	gr. 45 oz. 1.6
	CDR.7C	Insert $\phi 14$, 75° - ROUNDED	gr. 50 oz. 1.8
	CDR.7D	Insert $\phi 14$, 90° - ROUNDED	gr. 50 oz. 1.8
	CDR.7N	Insert $\phi 15$	gr. 40 oz. 1.4
	ZX.2N	Crimped 1/2" F fitting MV with GREEN ring nut	gr. 60 oz. 2.1
	ZX.5P	R1 Crimped $\phi 10$ (seat $\phi 14$) fitting K with crimped ferrule	gr. 50 oz. 1.8
	ZX.5Q	R1 Crimped $\phi 10$ (seat $\phi 16$) fitting K with crimped ferrule	gr. 50 oz. 1.8
	ZX.5R	R1 Crimped $\phi 10$ (seat $\phi 18$) fitting K with crimped ferrule	gr. 55 oz. 2.0
	ZX.7X	R2 Crimped $\phi 10$ (seat $\phi 14$) fitting K with crimped ferrule	gr. 55 oz. 2.0
	ZX.7Y	R2 Crimped $\phi 10$ (seat $\phi 16$) fitting K with crimped ferrule	gr. 55 oz. 2.0
	ZX.7Z	R2 Crimped $\phi 10$ (seat $\phi 18$) fitting K with crimped ferrule	gr. 60 oz. 2.1
	ZX.8A	R1 Crimped $\phi 11$ fitting K with crimped ferrule	gr. 55 oz. 2.0
	ZX.5S	R2 Crimped $\phi 11$ fitting K with crimped ferrule	gr. 60 oz. 2.1
	ZX.5T	R1 Crimped $\phi 11$ fitting K STAINLESS STEEL AISI 316 with crimped ferrule	gr. 55 oz. 2.0
	ZX.5U	R2 Crimped $\phi 11$ fitting K STAINLESS STEEL AISI 316 with crimped ferrule	gr. 55 oz. 2.0
	ZX.4G	Crimped M21x1,5 F $\phi 14$ with BLUE ring nut	gr. 70 oz. 2.5
	ZX.4H	Crimped M21x1,5 F $\phi 14$ 75° with BLUE ring nut	gr. 75 oz. 2.7
	ZX.4I	Crimped M21x1,5 F $\phi 14$ 90° with BLUE ring nut	gr. 75 oz. 2.7
	ZX.4J	Crimped M21x1,5 F $\phi 14$ neck 5 mm - ROUNDED with BLUE ring nut	gr. 70 oz. 2.5

FITTINGS	Code	Description	Weight
	ZX.4K	Crimped M21x1,5 F $\phi 14$ neck 14 mm - ROUNDED with BLUE ring nut	gr. 75 oz. 2.7
	ZX.2L	Crimped M22x1,5 F $\phi 14$ with HEXAGON nut STAINLESS STEEL AISI 316	gr. 110 oz. 3.9
	ZX.3P	Crimped M22x1,5 F $\phi 14$ with BLACK ring nut	gr. 75 oz. 2.7
	ZX.3Q	Crimped M22x1,5 F $\phi 14$ 75° with BLACK ring nut	gr. 80 oz. 2.8
	ZX.3R	Crimped M22x1,5 F $\phi 14$ 90° with BLACK ring nut	gr. 80 oz. 2.8
	ZX.3S	Crimped M22x1,5 F $\phi 14$ neck 5 mm - ROUNDED with BLACK ring nut	gr. 75 oz. 2.7
	ZX.3T	Crimped M22x1,5 F $\phi 14$ neck 14 mm - ROUNDED with BLACK ring nut	gr. 80 oz. 2.8
	ZX.3U	Crimped M22x1,5 F $\phi 14$ 75° - ROUNDED with BLACK ring nut	gr. 80 oz. 2.8
	ZX.3V	Crimped M22x1,5 F $\phi 14$ 90° - ROUNDED with BLACK ring nut	gr. 80 oz. 2.8
	ZX.4D	Crimped M22x1,5 F $\phi 14$ with BLACK "LONG" ring nut	gr. 85 oz. 3.0
	ZX.4E	Crimped M22x1,5 F $\phi 14$ neck 5 mm - ROUNDED w/ BLACK "LONG" ring nut	gr. 85 oz. 3.0
	ZX.4F	Crimped M22x1,5 F $\phi 14$ neck 14 mm - ROUNDED w/ BLACK "LONG" ring nut	gr. 90 oz. 3.2
	ZX.3W	Crimped M22x1,5 F $\phi 14$ with YELLOW ring nut	gr. 70 oz. 2.5
	ZX.3X	Crimped M22x1,5 F $\phi 14$ 75° with YELLOW ring nut	gr. 75 oz. 2.7
	ZX.3Y	Crimped M22x1,5 F $\phi 14$ 90° with YELLOW ring nut	gr. 75 oz. 2.7
	ZX.3Z	Crimped M22x1,5 F $\phi 14$ neck 5 mm - ROUNDED with YELLOW ring nut	gr. 70 oz. 2.5
	ZX.4A	Crimped M22x1,5 F $\phi 14$ neck 14 mm - ROUNDED with YELLOW ring nut	gr. 75 oz. 2.7
	ZX.4B	Crimped M22x1,5 F $\phi 14$ 75° - ROUNDED with YELLOW ring nut	gr. 75 oz. 2.7
	ZX.4C	Crimped M22x1,5 F $\phi 14$ 90° - ROUNDED with YELLOW ring nut	gr. 75 oz. 2.7
	ZX.5N	Crimped M22x1,5 F $\phi 15$ with DARK BLUE ring nut	gr. 75 oz. 2.7
	CDR.7P	Crimped fitting HOSE CONNECTION	gr. 110 oz. 3.9



High pressure hoses - R1 and R2 3/8" and fittings

The spare parts branded "CdR" exclusively refer to products by Club dei Riparatori® by IDROBASE®

R1 3/8" BLACK 210 bar-3050 psi



Code	Length m ft	Weight gr. oz.
ZN.BC100	10 32.80	gr. 3450 oz. 120.8
ZN.BC150	15 49.20	gr. 5170 oz. 181.0
ZN.BC200	20 65.60	gr. 6900 oz. 241.5
ZN.BC500	50 164.00	gr. 17200 oz. 602.0

R1 3/8" BLUE 210 bar-3050 psi



Code	Length m ft	Weight gr. oz.
ZB.BC100	10 32.80	gr. 3500 oz. 122.5
ZB.BC150	15 49.20	gr. 5250 oz. 183.8
ZB.BC200	20 65.60	gr. 7000 oz. 245.0
ZB.BC500	50 164.00	gr. 17500 oz. 612.5

R2 3/8" BLACK 400 bar-5800 psi



Code	Length m ft	Weight gr. oz.
ZN.EC100	10 32.80	gr. 5600 oz. 196.0
ZN.EC150	15 49.20	gr. 8400 oz. 294.0
ZN.EC200	20 65.60	gr. 11200 oz. 392.0
ZN.EC500	50 164.00	gr. 28000 oz. 980.0

R2 3/8" BLUE 400 bar-5800 psi



Code	Length m ft	Weight gr. oz.
ZB.EC100	10 32.80	gr. 5650 oz. 197.8
ZB.EC150	15 49.20	gr. 8470 oz. 296.5
ZB.EC200	20 65.60	gr. 11300 oz. 395.5
ZB.EC500	50 164.00	gr. 28200 oz. 987.0

FITTINGS



Code	Description	Weight gr. oz.
CDR.1J	R1 Black handle	gr. 80 oz. 2.8
CDR.1L	R1 Blue handle	gr. 80 oz. 2.8
CDR.1K	R1 Yellow handle	gr. 80 oz. 2.8
CDR.1M	R2 Black handle	gr. 80 oz. 2.8
CDR.1O	R2 Blue handle	gr. 80 oz. 2.8
CDR.1N	R2 Yellow handle	gr. 80 oz. 2.8
CDR.6A	R1 Crimped ferrule	gr. 40 oz. 1.4
CDR.6B	R1 crimped ferrule STAINLESS STEEL AISI 316	gr. 40 oz. 1.4
CDR.6C	R2 Crimped ferrule	gr. 45 oz. 1.6
CDR.6D	R2 crimped ferrule STAINLESS STEEL AISI 316	gr. 45 oz. 1.6
CDR.2D	Crimped G 3/8" F	gr. 50 oz. 1.8
CDR.2E	Crimped G 3/8" M	gr. 45 oz. 1.6
CDR.2J	Crimped G 3/8" F STAINLESS STEEL AISI 316	gr. 50 oz. 1.8
CDR.2F	Crimped G 1/2" F	gr. 75 oz. 2.7
CDR.2G	Crimped G 1/2" M	gr. 70 oz. 2.5

FITTINGS



Code	Description	Weight gr. oz.
CDR.2K	Crimped G 1/2" F STAINLESS STEEL AISI 316	gr. 75 oz. 2.7
CDR.6F	GREEN ring nut for 1/2" F crimped fitting MV	gr. 30 oz. 1.1
CDR.6J	BLACK ring nut for M22x1,5 F ø14 crimped	gr. 35 oz. 1.3
CDR.6K	BLACK "LONG" ring nut for M22x1,5 F ø14 crimped	gr. 45 oz. 1.6
CDR.6L	HEXAGON nut for M22x1,5 F ø14 crimped STAINLESS STEEL AISI 316	gr. 75 oz. 2.7
CDR.6M	YELLOW ring nut for M22x1,5 F ø14 crimped	gr. 30 oz. 1.1
CDR.6N	BLUE ring nut for M21x1,5 F ø14 crimped	gr. 30 oz. 1.1
CDR.6O	DARK BLUE ring nut for M22x1,5 F ø15 crimped	gr. 35 oz. 1.3
CDR.6I	Insert for crimped fitting 1/2" F fitting MV	gr. 30 oz. 1.1
CDR.7E	Insert ø14	gr. 40 oz. 1.4
CDR.7F	Insert ø14 STAINLESS STEEL AISI 316	gr. 40 oz. 1.4
CDR.7G	Insert ø14, 75°	gr. 50 oz. 1.8
CDR.7H	Insert ø14, 90°	gr. 50 oz. 1.8
CDR.7I	Insert ø14, neck 5 mm - ROUNDED	gr. 40 oz. 1.4
CDR.7J	Insert ø14, neck 14 mm - ROUNDED	gr. 45 oz. 1.6



High pressure hoses - R1 and R2 3/8" and fittings

The spare parts branded "CdR" exclusively refer to products by Club dei Riparatori® by IDROBASE®

FITTINGS	Code	Description	Weight
	CDR.7K	Insert $\phi 14$, 75° - ROUNDED	gr. 50 oz. 1.8
	CDR.7L	Insert $\phi 14$, 90° - ROUNDED	gr. 50 oz. 1.8
	ZX.20	Crimped 1/2" F fitting MV with GREEN ring nut	gr. 60 oz. 2.1
	ZX.5F	Crimped M21x1,5 F $\phi 14$ with BLUE ring nut	gr. 70 oz. 2.5
	ZX.5G	Crimped M21x1,5 F $\phi 14$ 75° with BLUE ring nut	gr. 75 oz. 2.7
	ZX.5H	Crimped M21x1,5 F $\phi 14$ 90° with BLUE ring nut	gr. 75 oz. 2.7
	ZX.5I	Crimped M21x1,5 F $\phi 14$ neck 5 mm - ROUNDED with BLUE ring nut	gr. 70 oz. 2.5
	ZX.5J	Crimped M21x1,5 F $\phi 14$ neck 14 mm - ROUNDED with BLUE ring nut	gr. 75 oz. 2.7
	ZX.2V	Crimped M22x1,5 F $\phi 14$ with HEXAGON nut STAINLESS STEEL AISI 316	gr. 110 oz. 3.9
	ZX.4N	Crimped M22x1,5 F $\phi 14$ with BLACK ring nut	gr. 75 oz. 2.7
	ZX.40	Crimped M22x1,5 F $\phi 14$ 75° with BLACK ring nut	gr. 80 oz. 2.8
	ZX.4P	Crimped M22x1,5 F $\phi 14$ 90° with BLACK ring nut	gr. 80 oz. 2.8
	ZX.4Q	Crimped M22x1,5 F $\phi 14$ neck 5 mm - ROUNDED with BLACK ring nut	gr. 75 oz. 2.7
	ZX.4R	Crimped M22x1,5 F $\phi 14$ neck 14 mm - ROUNDED with BLACK ring nut	gr. 80 oz. 2.8

FITTINGS	Code	Description	Weight
	ZX.4S	Crimped M22x1,5 F $\phi 14$ 75° - ROUNDED with BLACK ring nut	gr. 80 oz. 2.8
	ZX.4T	Crimped M22x1,5 F $\phi 14$ 90° - ROUNDED with BLACK ring nut	gr. 80 oz. 2.8
	ZX.5B	Crimped M22x1,5 F $\phi 14$ with BLACK "LONG" ring nut	gr. 85 oz. 3.0
	ZX.5D	Crimped M22x1,5 F $\phi 14$ neck 5 mm - ROUNDED w/ BLACK "LONG" ring nut	gr. 85 oz. 3.0
	ZX.5E	Crimped M22x1,5 F $\phi 14$ neck 14 mm - ROUNDED w/ BLACK "LONG" ring nut	gr. 90 oz. 3.2
	ZX.4U	Crimped M22x1,5 F $\phi 14$ with YELLOW ring nut	gr. 70 oz. 2.5
	ZX.4V	Crimped M22x1,5 F $\phi 14$ 75° with YELLOW ring nut	gr. 75 oz. 2.7
	ZX.4W	Crimped M22x1,5 F $\phi 14$ 90° with YELLOW ring nut	gr. 75 oz. 2.7
	ZX.4X	Crimped M22x1,5 F $\phi 14$ neck 5 mm - ROUNDED with YELLOW ring nut	gr. 70 oz. 2.5
	ZX.4Y	Crimped M22x1,5 F $\phi 14$ neck 14 mm - ROUNDED with YELLOW ring nut	gr. 75 oz. 2.7
	ZX.4Z	Crimped M22x1,5 F $\phi 14$ 75° - ROUNDED with YELLOW ring nut	gr. 75 oz. 2.7
	ZX.5A	Crimped M22x1,5 F $\phi 14$ 90° - ROUNDED with YELLOW ring nut	gr. 75 oz. 2.7
	CDR.7Q	Crimped fitting HOSE CONNECTION	gr. 115 oz. 4.0



High pressure hoses - R2 3/8" 500 bar and fittings

The spare parts branded "CdR" exclusively refer to products by Club dei Riparatori® by IDROBASE®

R2 3/8" 500 bar BLACK	Code	Length m ft	Weight
	ZN.FC100	10 32.80	gr. 4850 oz. 169.8
	ZN.FC150	15 49.20	gr. 7270 oz. 254.5
	ZN.FC200	20 65.60	gr. 9700 oz. 339.8
	ZN.FC500	50 164.00	gr. 24200 oz. 847.0

Only h.p. hose



FITTINGS	Code	Description	Weight
	CDR.1P	Black handle	gr. 80 oz. 2.8
	CDR.1Q	Yellow handle	gr. 80 oz. 2.8

FITTINGS	Code	Description	Weight
	CDR.6E	Crimped ferrule	gr. 45 oz. 1.6
	CDR.2D	Crimped G 3/8" F	gr. 50 oz. 1.8
	CDR.2E	Crimped G 3/8" M	gr. 45 oz. 1.6
	CDR.2F	Crimped G 1/2" F	gr. 75 oz. 2.7
	CDR.2G	Crimped G 1/2" M	gr. 70 oz. 2.5
	CDR.7R	Crimped fitting HOSE CONNECTION	gr. 110 oz. 3.9



H.p. sewer hose 210 bar(3050 psi) - R7 3/16"

The spare parts branded "CdR" exclusively refer to products by Club dei Riparatori® by IDROBASE®

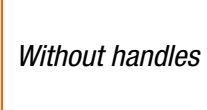
BLACK	Code	Length m ft	Weight
 G 1/4" M	ZN.MC080X9B9C	8 26.25	gr. 600 oz. 21.0
 G 1/8" M	ZN.MC100X9B9C	10 32.80	gr. 750 oz. 26.3
 Without handles	ZN.MC150X9B9C	15 49.20	gr. 1100 oz. 38.5
	ZN.MC200X9B9C	20 65.60	gr. 1450 oz. 50.8

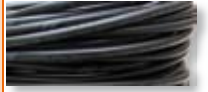

R7 3/16" BLACK 210 bar-3050 psi	Code	Length m ft	Weight
 Only h.p. hose	ZN.MC10X	100 328.00	gr. 7000 oz. 245.0

FITTINGS	Code	Description	Weight
	CDR.9A	Crimped ferrule	gr. 20 oz. 0.7
	CDR.9B	Crimped G 1/8" M + O-Ring	gr. 20 oz. 0.7
	CDR.9C	Crimped G 1/4" M + O-Ring	gr. 40 oz. 1.4



H.p. thermoplastic hose 140 bar(2000 psi) - 1/4"

The spare parts branded "CdR" exclusively refer to products by Club dei Riparatori® by IDROBASE®

BLACK	Code	Length m ft	Weight
 G 1/4" F	ZN.LC080B1R1R	8 26.25	gr. 800 oz. 28.0
 G 1/8" F	ZN.LC150B1R1R	15 49.20	gr. 1400 oz. 48.0

With handles

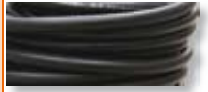
1/4" BLACK 140 bar-2000 psi	Code	Length m ft	Weight
 Only h.p. hose	ZN.LC10X	100 328.00	gr. 9000 oz. 315.0

BLACK	Code	Length m ft	Weight
 M 22x14 F	ZN.LC080B2P1R	8 26.25	gr. 800 oz. 28.0
 M 22x14 F	ZN.LC150B2P1R	15 49.20	gr. 1400 oz. 48.0

With handles

FITTINGS	Code	Description	Weight
	CDR.9E	Black handle	gr. 40 oz. 1.4
	CDR.9D	Crimped ferrule	gr. 20 oz. 0.7
	CDR.1R	Crimped G 1/4" F	gr. 30 oz. 1.1
	CDR.1S	Crimped G 1/4" M	gr. 25 oz. 0.9
	CDR.1T	Crimped G 3/8" F	gr. 40 oz. 1.4
	CDR.1U	Crimped G 3/8" M	gr. 40 oz. 1.4
	ZX.2P	Crimped M22x1,5 F x14 with BLACK ring nut	gr. 70 oz. 2.5
	ZX.5M	Crimped M22x1,5 F x15 with DARK BLUE ring nut	gr. 75 oz. 2.7

BLACK	Code	Length m ft	Weight
 M 22x15 F	ZN.LC080B5M1R	8 26.25	gr. 800 oz. 28.0
 M 22x15 F	ZN.LC150B5M1R	15 49.20	gr. 1400 oz. 48.0

With handles



High pressure hoses - Made to measure (order form)

The spare parts branded "CdR" exclusively refer to products by Club dei Riparatori® by IDROBASE®

Company _____
 Ref. _____
 Address _____ ZIP CODE _____
 Town/City _____
 Country _____ e-mail _____
 Phone _____ Fax _____

High pressure hoses made to measure MINIMUM QUANTITY AND ASSEMBLY COSTS

Code	Description		
ZX.TUB01	For size LESS THAN 1 metre	minimum order 30 pcs	see price list
ZX.TUB02	For size from 1 to 3 metres	minimum order 10 pcs	see price list
ZX.TUB03	For size GREATER THAN 3 metres	minimum order 10 pcs	see price list

<i>QUANTITY of high pressure hose</i> _____	<i>COLOUR of high pressure hose (make a cross)</i>		
	BLACK		BLUE

<i>TYPE of high pressure hose to manufacture (make a cross)</i>					
R1 1/4 210 bar 3050 psi	R1 3/8 210 bar 3050 psi	R1 5/16 315 bar 4550 psi	R2 5/16 400 bar 5800 psi	R2 3/8 400 bar 5800 psi	R2 3/8 500 bar 7250 psi

<i>Length of hose TO BE CUT</i> in centimetres _____	<i>COLOUR and NUMBER of handles (cross the corresponding letter)</i>						
	NO HANDLE/S	"A" BLACK	"A" BLUE	"A" YELLOW	"B" BLACK	"B" BLUE	"B" YELLOW

*Write FITTING CODE you require below
(See catalogue pages 194-200)*

END "A"	END "B"
----------------	----------------

<i>Choose the angle (make a cross)</i>	<i>Write below different angle if required</i>				
<table style="width: 100%;"> <tr> <td style="text-align: center;">"A" </td> <td style="text-align: center;">"B" </td> </tr> <tr> <td style="text-align: center;">"A" </td> <td style="text-align: center;">"B" </td> </tr> </table>	"A" 	"B" 	"A" 	"B" 	
"A" 	"B" 				
"A" 	"B" 				

Code _____

*To be completed
by Club dei Riparatori*

Riparatori®

Club dei
Riparatori®

Club dei
Riparatori®

OUR LINE OF ACCESSORIES

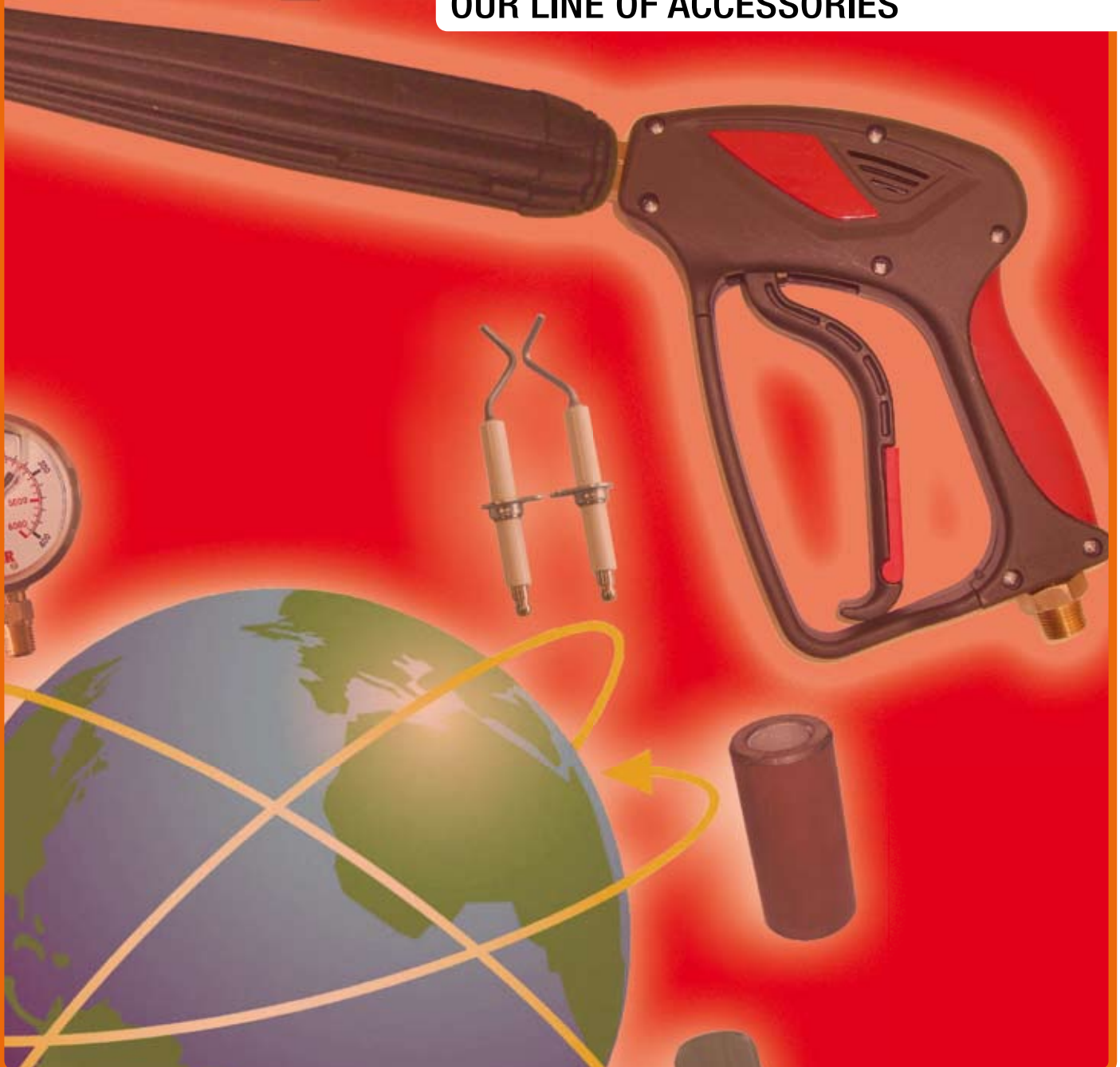



Our line of accessories

Innovative approaches by thinking outside of the box

The way we meet the needs of the customer has enabled us to innovate and to improve on a poor product, so that finally it meets the requirements of the user; more performance, more useful, safer and more comfortable than the products of the past.

The only thing that will remain unchanged with respect to the products of yesterday is its selling price, which will be of great benefit to our distributors and clients, and of great concern to our competitors.



The reason for a new line of high pressure washer accessories

It is well known that through the gun and the lance, the pressure washer can transmit strong vibrations from the pump to the user.

The strength generated by the pressure and force of the water jet that exits the lance through the nozzle, together with the shocks caused by the repeated opening and closing of the trigger of the gun can cause stress that can fatigue the hands, forearms and also the shoulders of the user. In some cases this can result in "tennis elbow".

This is a genuine and serious occupational hazard that affects users of high pressure washers.

Club dei Riparatori of Idrobase, with its new line of accessories transforms what was previously tiring and stressful cleaning into a simple and relaxing job.



CdR® 90 and 990 are professional guns.

The ergonomic grip enables the gun to be held comfortably and securely, and distributes the force applied to the gun by the water jet evenly through the hand. The surface of the gun that is in contact with the palm was specifically designed in *soft rubber* to cushion the vibrations transmitted by the pump.

The inclination of the gun connected to the lance is perfectly balanced, reducing the force imparted by the water jet.



CdR® 90 spray guns

Max: 280 bar-4050 psi, 25 l/min-6.60 USGpm, 150 °C-300 °F

Code	Inlet	Outlet	Weight	
			gr.	oz.
CDR.7400	G 3/8" F	G 1/4" F	650	22.8
CDR.7402	G 3/8" M	G 1/4" F	670	23.5
CDR.7403	M 22x1,5 M	G 1/4" F	685	24.0



CdR® 990 spray guns

Max: 345 bar-5000 psi, 40 l/min-10.50 USGpm, 150 °C-300 °F

Code	Inlet	Outlet	Weight	
			gr.	oz.
CDR.7404	G 3/8" F	G 1/4" F	650	22.8
CDR.7406	G 3/8" M	G 1/4" F	670	23.5
CDR.7407	M 22x1,5 M	G 1/4" F	670	23.5
CDR.7408	M 22x1,5 M	M 22x1,5 M	685	24.0



Lances - CdR® 80 moulded handle

The spare parts branded "CdR®" exclusively refer to products by Club dei Riparatori® by IDROBASE®

CdR® 80 professional moulded handle lances

will offer the user the following advantages over the previous, old models:

- **A rubber casing covers** the space between the gun and lance combining them into one. This unique solution, the only one in the world, protects the operator from potential electric shocks and therefore satisfying health and safety regulations.
- **The ergonomic handle**, as well as making the lance enjoyable to use, makes it easy to hold and reduces fatigue that can result after heavy, continuous use. Even under heavy usage the lance does not tire the arms and shoulders.
- **The bend** is designed to perfectly balance the strength of the water jet against the weight of the gun. The result is a lance that the operator can use with just one hand.
- **The special nozzle cover** protects the nozzle and eliminates the possibility of scratching the surface being cleaned and gives the operator a useful guideline to follow while washing.

CdR® 80 moulded handle lance with bend

Max: 280 bar-4050 psi, 40 l/min-10.50 USGpm, 150 °C-300 °F

Code	Length		Inlet	Outlet	Weight	
	mm	inches			gr.	oz.
ZX.7114	500	20"	G 1/4" M	1/4" NPT-F	390	13.7
ZX.7115	700	28"	G 1/4" M	1/4" NPT-F	480	16.8
ZX.7116	900	36"	G 1/4" M	1/4" NPT-F	580	20.3
ZX.7117	1200	47"	G 1/4" M	1/4" NPT-F	830	29.1
ZX.7118	1500	59"	G 1/4" M	1/4" NPT-F	1040	36.4
ZX.7119	1700	67"	G 1/4" M	1/4" NPT-F	1140	39.9
ZX.7120	2000	79"	G 1/4" M	1/4" NPT-F	1240	43.4

Made of
chromed steel

CdR® 80 moulded handle straight lance

Max: 280 bar-4050 psi, 40 l/min-10.50 USGpm, 150 °C-300 °F

Code	Length		Inlet	Outlet	Weight	
	mm	inches			gr.	oz.
ZX.7127	700	28"	G 1/4" M	1/4" NPT-F	480	16.8
ZX.7128	900	36"	G 1/4" M	1/4" NPT-F	580	20.3
ZX.7129	1200	47"	G 1/4" M	1/4" NPT-F	830	29.1

Made of
chromed steel

CdR® 80 moulded blue handle lance with bend

Max: 280 bar-4050 psi, 40 l/min-10.50 USGpm, 150 °C-300 °F

Code	Length		Inlet	Outlet	Weight	
	mm	inches			gr.	oz.
ZX.7124	700	28"	G 1/4" M	1/4" NPT-F	500	17.5
ZX.7125	900	36"	G 1/4" M	1/4" NPT-F	590	20.7
ZX.7126	1200	47"	G 1/4" M	1/4" NPT-F	880	30.8

Made of
stainless steel
AISI 304



Lances
- CdR® 55 vented handle

The spare parts branded "CdR®" exclusively refer to products by Club dei Riparatori® by IDROBASE®



CdR® 55 professional vented handle lances

will offer the user the following advantages over the previous, old models:

- **Soft handle** provides thermal insulation and a secure connection which allows the handle to be housed securely next to the gun, thus combining the two components into one.
- **The bend** is designed to perfectly balance the strength of the water jet against the weight of the gun. The result is a lance that feels more like a feather in the hands of the operator and can be used effortlessly even with just one hand.
- **The special nozzle cover** protects the nozzle and eliminates the possibility of scratching the surface being cleaned and gives the operator a useful guideline to follow while washing.

CdR® 55 vented handle lances, with bend

Max: 280 bar-4050 PSI, 40 l/min-10.50 USGpm, 150 °C-300 °F

Code	Length		Inlet	Outlet	Weight	
	mm	inches			gr.	oz.
ZX.7106	500	20"	G 1/4" M	1/4" NPT-F	475	16.7
ZX.7107	700	28"	G 1/4" M	1/4" NPT-F	550	19.3
ZX.7108	900	36"	G 1/4" M	1/4" NPT-F	630	22.1
ZX.7109	1200	47"	G 1/4" M	1/4" NPT-F	970	34.0
ZX.7110	1500	59"	G 1/4" M	1/4" NPT-F	1090	38.2
ZX.7111	1700	67"	G 1/4" M	1/4" NPT-F	1170	38.2
ZX.7112	2000	79"	G 1/4" M	1/4" NPT-F	1295	45.4

Made of
chromed steel



Lances
- CdR® 55 vented handle, fitting Kärcher

The spare parts branded "CdR" exclusively refer to products by Club dei Riparatori® by IDROBASE®



**CdR® 55
vented handle
lances
fitting Kärcher**

Max:
280 bar-4050 psi
40 l/min-10.50 USGpm
150 °C-300 °F

Code	Length		Inlet	Outlet	Weight	
	mm	inches			gr.	oz.
ZX.1071-M18	500	20"	M 22x1,5 F	M 18x1 M	670	23.5
ZX.1072-M18	700	28"	M 22x1,5 F	M 18x1 M	750	26.3
ZX.1073-M18	900	36"	M 22x1,5 F	M 18x1 M	830	29.1
ZX.1074-M18	1200	47"	M 22x1,5 F	M 18x1 M	1170	41.0
ZX.1075-M18	1500	59"	M 22x1,5 F	M 18x1 M	1290	45.2
ZX.1076-M18	1700	67"	M 22x1,5 F	M 18x1 M	1370	48.0
ZX.1077-M18	2000	79"	M 22x1,5 F	M 18x1 M	1490	52.2

Made of
chromed steel

ZX.7019

Brass adapter fitting Kärcher,
inlet M 18x1 F,
outlet G 1/4" M.

It is ideal to mount
inlet G 1/4" F nozzles
on lances fitting
Kärcher with con-
nection M 18x1 M.



gr. 30
oz. 1.8

CDR.7023

Tip retainer,
M 18x1 F



gr. 30
oz. 1.1

CDR.7024

Brass nozzle holder,
G 1/4" F-M 18x1 M



gr. 30
oz. 1.1

ZX.0154

Set O-Ring for brass nozzle
holder
(code CDR.7024)



gr. 20
oz. 0.9

quantity
1x100



Spray guns
- CdR® 90 and 990 with extension

The spare parts branded "CdR" exclusively refer to products by Club dei Riparatori® by IDROBASE®

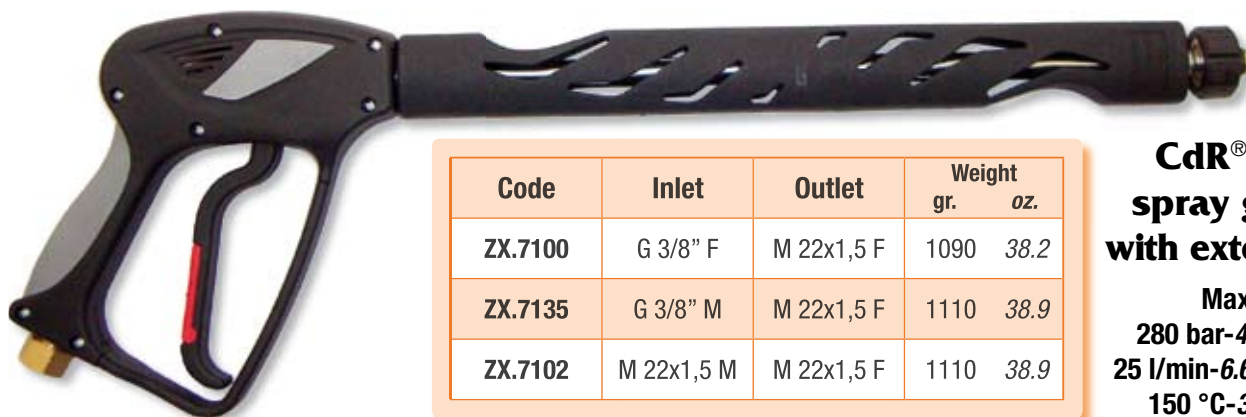

**CdR® 90
spray guns
with extension**

Max:
280 bar-4050 psi
25 l/min-6.60 USGpm
150 °C-300 °F

Code	Inlet	Outlet	Weight	
			gr.	oz.
ZX.7100	G 3/8" F	M 22x1,5 F	1090	38.2
ZX.7135	G 3/8" M	M 22x1,5 F	1110	38.9
ZX.7102	M 22x1,5 M	M 22x1,5 F	1110	38.9



**CdR® 990
spray guns
with extension**

Max:
345 bar-5000 psi
40 l/min-10.50 USGpm
150 °C-300 °F

Code	Inlet	Outlet	Weight	
			gr.	oz.
ZX.7103	G 3/8" F	M 22x1,5 F	1090	38.2
ZX.7136	G 3/8" M	M 22x1,5 F	1110	38.9
ZX.7105	M 22x1,5 M	M 22x1,5 F	1110	38.9



Lances - Extension and nozzle holders

The spare parts branded "CdR" exclusively refer to products by Club dei Riparatori® by IDROBASE®

CDR.7409

CdR 60 vented handle extension for gun, 380 mm-15".
Made of chromed steel,
inlet G 1/4" M,
outlet M 22x1,5 F.



gr. 440
oz. 15.4
280 bar-4050 PSI, 40 l/min-10.50 GPM, 150 °C-300 °F.

CDR.7410

CdR 70 extension lance without nozzle holder, 580 mm-23"
Made of chromed steel,
inlet M 22x1,5 M,
outlet G 1/4" M.



gr. 400
oz. 14.0
280 bar-4050 PSI, 40 l/min-10.50 GPM, 150 °C-300 °F.

ZX.7113

CdR 7 nozzle holder with black protection.
Made of zinced steel,
inlet G 1/4" F,
outlet 1/4" NPT-F.



gr. 45
oz. 1.6

ZX.7140

CdR 7 nozzle holder with blue protection.
Made of stainless steel,
inlet G 1/4" F,
outlet 1/4" NPT-F.



gr. 45
oz. 1.6

CDR.7026

H.p. ball quick nozzle holder with black protection.
Made of brass,
inlet G 1/4" F,
outlet "quick".



gr. 70
oz. 2.5
250 bar-3600 PSI, 30 l/min-8.00 GPM,
90 °C-195 °F.

Lances - Double lances and surface cleaners

AL.391317

Double lance 1005 mm, straight,
inlet G1/4M, outlet 2x1/4 NPT-F,
melted handle, with nozzle holder
and protection



gr. 1100
oz. 38.5
280 bar-4050 psi,
40 l/min-10.50 USGpm, 150 °C-300 °F.
Made of chromed steel pipe

MV.0202004721

Double lance extension 700 mm-27.6"
with insulated handle,
inlet M 22x1,5 M, outlet 2 x 1/4" NPT-F,



gr. 1100
oz. 38.5
280 bar-4050 psi,
40 l/min-10.50 USGpm, 150 °C-300 °F.
Made of chromed steel pipe

CDR.0358

Plastic surface cleaner,
inlet M 22x1,5 F, 210 bar-3050 psi,
15 l/min-4.00 USGpm, 60 °C-140 °F
*Suitable for semi-professional use. Rubber surface
cleaner with revolution nozzles device. Rubber cover,
stainless steel and brass revolving arm device,
400 mm-15.8" extension.*



gr. 3600
oz. 126.0
Supplied
without nozzles

Spray guns - Professionals

AL.017433804

Spray gun SK2,
inlet G 3/8" F,
outlet G 1/4" F,
250 bar-3650 psi,
25 l/min-6.60 USGpm,
60 °C-140 °F



gr. 340
oz. 11.9

AL.017433800

Spray gun SK2,
inlet M 22x1,5 M,
outlet G 1/4" F,
250 bar-3650 psi,
25 l/min-6.60 USGpm,
60 °C-140 °F



gr. 340
oz. 11.9

CDR.0300

**Spray gun,
compensated blue,**
inlet G 3/8" F,
outlet G 1/4" F,
350 bar-5100 psi,
30 l/min-8.00 USGpm,
160 °C-320 °F



gr. 660
oz. 23.1

CDR.1259

RL56 spare parts kit



gr. 11
oz. 0.4

CDR.0955

VEGA spare parts kit



gr. 11
oz. 0.4

ZX.0339

MV 920 spare parts kit



gr. 16
oz. 0.6

Nozzles

- Table for the suitable nozzle

Flow rate in l/min-USGpm at the indicated pressure bar-psi

Pressure	NOZZLE																			Flow rate	
	02	03	035	04	045	05	055	06	065	07	075	08	085	09	10	11	12	13	14		15
50 bar	3,2	4,8	5,5	6,6	7,1	8	8,7	9,6	10,4	11,2	12	12,7	13,5	14,3	16	17,3	18,9	20,5	22,1	23,9	l/min
725 psi	0.9	1.3	1.5	1.8	1.9	2.1	2.3	2.6	2.8	3.0	3.2	3.4	3.6	3.8	4.3	4.6	5.0	5.5	5.9	6.4	USGpm
60 bar	3,5	5,3	6	7,3	7,8	8,7	9,6	10,4	11,3	12,2	13,1	14	14,8	15,7	17,4	19	20,8	22,5	24,2	26,1	l/min
870 psi	0.9	1.4	1.6	1.9	2.1	2.3	2.6	2.8	3.0	3.3	3.5	3.7	3.9	4.2	4.6	5.1	5.5	6.0	6.5	7.0	USGpm
70 bar	3,7	5,7	6,5	7,8	8,4	9,4	10,3	11,3	12,3	13,2	14,2	15,1	16	17	18,9	20,5	22,4	24,3	26,1	28,3	l/min
1015 psi	1	1.5	1.7	2.1	2.2	2.5	2.7	3.0	3.3	3.5	3.8	4.0	4.3	4.5	5.0	5.5	6.0	6.5	7.0	7.5	USGpm
80 bar	4	6,1	7	8,4	9	10	11,1	12,1	13,2	14,1	15,2	16,1	17,1	18	20,1	22	24	26	28	30,2	l/min
1160 psi	1.1	1.6	1.9	2.2	2.4	2.7	3.0	3.2	3.5	3.8	4.1	4.3	4.6	4.8	5.4	5.9	6.4	6.9	7.5	8.1	USGpm
90 bar	4,2	6,3	7,4	8,9	9,6	10,7	11,8	12,8	14	15	16,1	17,1	18,1	19,2	21,4	23,3	25,4	27,5	29,6	32,1	l/min
1305 psi	1.1	1.7	2.0	2.4	2.6	2.9	3.1	3.4	3.7	4.0	4.3	4.6	4.8	5.1	5.7	6.2	6.8	7.3	7.9	8.6	USGpm
100 bar	4,5	6,8	7,8	9,4	10,2	11,3	12,4	13,6	14,7	15,8	16,9	18	19,1	20,2	22,5	24,5	26,8	29	31,3	33,8	l/min
1450 psi	1.2	1.8	2.1	2.5	2.7	3.1	3.3	3.6	3.9	4.2	4.5	4.8	5.1	5.4	6.0	6.5	7.1	7.7	8.3	9.0	USGpm
110 bar	4,7	7,1	8,2	9,8	10,5	11,8	13	14,3	15,4	16,6	17,7	18,9	20	21,2	23,6	25,7	28,1	30,4	32,8	35,3	l/min
1395 psi	1.3	1.9	2.2	2.6	2.8	3.1	3.5	3.8	4.1	4.4	4.7	5.0	5,3	5,7	6,3	6,9	7,5	8,1	8,7	9,4	USGpm
120 bar	4,8	7,4	8,6	10,3	10,9	12,4	13,6	14,9	16,1	17,3	18,5	19,7	20,9	22,1	24,6	26,9	29,4	31,8	34,2	36,9	l/min
1740 psi	1.3	2.0	2.3	2.7	2.9	3.3	3.6	4.0	4.3	4.6	4.9	5.3	5.6	5.9	6.6	7.2	7.8	8.5	9.1	9.8	USGpm
130 bar	5	7,7	8,9	10,7	11,4	12,9	14,1	15,5	16,8	18	19,3	20,5	21,8	23	25,6	28	30,6	33,1	35,6	38,4	l/min
1885 psi	1.3	2.1	2.4	2.9	3.0	3.4	3.8	4.1	4.5	4.8	5.1	5.5	5.8	6.1	6.8	7.5	8.2	8.8	9.5	10.2	USGpm
140 bar	5,3	8	9,2	11,1	11,8	13,4	14,7	16	17,4	18,7	20	21,3	22,6	23,9	26,6	29,1	31,7	34,4	37	39,9	l/min
2030 psi	1.4	2.1	2.5	3.0	3.1	3.6	3.9	4,3	4,6	5.0	5.3	5.7	6.0	6.4	7.1	7.8	8.5	9.2	9.9	10.6	USGpm
150 bar	5,4	8,3	9,5	11,5	12,2	13,8	15,2	16,7	18	19,3	20,7	22	23,4	24,7	27,6	30,1	32,8	35,6	38,3	41,3	l/min
2175 psi	1.4	2.2	2.5	3.1	3.3	3.7	4.1	4.5	4.8	5.1	5.5	5.9	6.2	6.6	7.4	8.0	8.7	9.5	10.2	11.0	USGpm
170 bar	6,0	8,9	10,2	11,9	13,4	14,9	16,3	17,9	19,3	20,9	22,3	23,7	25,3	24,4	30	32,6	35,2	39,1	41,7	44,3	l/min
2465 psi	1.6	2.3	2.7	3.1	3.5	3.9	4.3	4.7	5.1	5.5	5,9	6,3	6,7	7,2	7,9	8,6	9,3	10,3	11,0	11,7	USGpm
180 bar	6,2	9,1	10,5	12,2	13,8	15,3	16,8	18,4	19,9	21,5	22,9	24,4	26	28,2	30,9	33,5	36,2	40,2	42,9	45,6	l/min
2610 psi	1.6	2.4	2.8	3.2	3.7	4.0	4.4	4.9	5.2	5.7	6.1	6.5	6.9	7.4	8.2	8.9	9.6	10.6	11.3	12.1	USGpm
200 bar	6,3	9,6	11	13,3	14,1	16	17,5	19,2	20,8	22,3	23,9	25,2	27	28,6	31,8	34,7	37,9	41,1	44,3	47,7	l/min
2900 psi	1.7	2.6	2.9	3.5	3.8	4.3	4.7	5.1	5.5	5.9	6.4	6.7	7.2	7.6	8.5	9.3	10.1	11.0	11.8	12.7	USGpm
225 bar	6,7	10,2	11,7	14,1	15	16,9	18,6	20,4	22	23,7	25,3	27	28,6	30,3	33,7	36,8	40,2	43,6	46,9	50,6	l/min
3263 psi	1.8	2.7	3.1	3.8	4.0	4.5	5.0	5.4	5.9	6.3	6.7	7,2	7,6	8.1	9.0	9.8	10.7	11.6	12.5	13.5	USGpm
250 bar	7	10,7	12,3	14,8	15,8	17,9	19,6	21,5	23,2	25	26,7	28,5	30,2	31,9	35,6	38,8	42,4	45,9	49,4	53,3	l/min
3625 psi	1.9	2.9	3.3	3.9	4.2	4.8	5.2	5.7	6.2	6.7	7.1	7.6	8.1	8.5	9.5	10.3	11.3	12.2	13.2	14.2	USGpm
275 bar	7,6	11,2	12,8	15	16,9	18,7	20,5	22,5	24,3	26,3	28,1	29,9	31,9	34,5	37,8	41,1	44,9	49,3	52,6	55,9	l/min
3988 psi	2.0	3.0	3.4	4.0	4.5	4.9	5.4	5.9	6.4	6.9	7.4	7.9	8.4	9.1	10.0	10.9	11.7	13.0	13.9	14.8	USGpm
300 bar	7,9	11,9	13,5	15,8	17,9	19,8	21,7	23,7	25,7	27,8	29,6	31,5	33,5	36,4	39,7	43,2	46,8	51,9	55,4	58,8	l/min
4350 psi	2.1	3.2	3.6	4.2	4.8	5.3	5.8	6.3	6.9	7.4	7.9	8.4	8.9	9.7	10.6	11.5	12.5	13.8	14.8	15.7	USGpm
350 bar	8,5	12,8	14,6	17	19,3	21,3	23,5	25,7	27,8	29,9	32	34,1	36,1	39,3	43,1	46,7	50,4	56,2	60	63,5	l/min
5075 psi	2.3	3.4	3.9	4.5	5.1	5.7	6.3	6.9	7.4	8.0	8.5	9.1	9.6	10.5	11.5	12.5	13.4	15.0	16,0	16.9	USGpm
400 bar	9	13,6	15,6	18,2	20,7	22,9	25,1	27,5	29,7	32,1	34,2	36,3	38,7	41,8	46,2	50,1	54,1	60,2	63,9	68,1	l/min
5800 psi	2.4	3.6	4.2	4.9	5.5	6.1	6.7	7.3	7.9	8.6	9.1	9.7	10.3	11.1	12.3	13.4	14.4	16.1	17.0	18.2	USGpm
450 bar	9,6	14,5	16,5	19,3	21,8	24,2	26,6	29,2	31,5	34,1	36,3	38,5	41,1	44,4	49	53,1	57,3	63,6	67,9	72,1	l/min
6525 psi	2,6	3,9	4,4	5,1	5,8	6,5	7,1	7,8	8,4	9,1	9,7	10,3	11,0	11,8	13,1	14,2	15,3	17,0	18,1	19,2	USGpm
500 bar	10,2	15,2	17,3	20,2	22,9	25,6	28,2	30,7	33,2	36	38,2	40,8	43,5	47,1	51,5	55,9	60,4	67,1	71,6	76,1	l/min
7250 psi	2,7	4,1	4,6	5,4	6,1	6,8	7,5	8,2	8,9	9,6	10,2	10,9	11,6	12,6	13,7	14,9	16,1	17,9	19,1	20,3	USGpm

Nozzles

- H.p. nozzles, NPT-M

H.p. nozzles 1/8" NPT-M



Products of the highest quality, chosen and distributed by Club dei Riparatori to ensure the best value for money available today.

gr. 20
oz. 0.7

Code	Angle	Flow rate
C.18MEG0003	0°	03
C.18MEG00035	0°	035
C.18MEG0004	0°	04
C.18MEG00045	0°	045
C.18MEG0005	0°	05
C.18MEG00055	0°	055
C.18MEG0006	0°	06
C.18MEG0007	0°	07
C.18MEG0008	0°	08
C.18MEG1503	15°	03
C.18MEG15035	15°	035
C.18MEG1504	15°	04
C.18MEG15045	15°	045
C.18MEG1505	15°	05
C.18MEG15055	15°	055
C.18MEG1506	15°	06
C.18MEG1507	15°	07
C.18MEG1508	15°	08
C.18MEG2503	25°	03
C.18MEG25035	25°	035
C.18MEG2504	25°	04
C.18MEG25045	25°	045
C.18MEG2505	25°	05
C.18MEG25055	25°	055
C.18MEG2506	25°	06
C.18MEG2507	25°	07
C.18MEG2508	25°	08
C.18MEG4003	40°	03
C.18MEG40035	40°	035
C.18MEG4004	40°	04
C.18MEG40045	40°	045
C.18MEG4005	40°	05
C.18MEG40055	40°	055

H.p. nozzles 1/4" NPT-M



Products of the highest quality, chosen and distributed by Club dei Riparatori to ensure the best value for money available today.

gr. 20
oz. 0.7

Code	Angle	Flow rate
C.MEG0003	0°	03
C.MEG00035	0°	035
C.MEG0004	0°	04
C.MEG00045	0°	045
C.MEG0005	0°	05
C.MEG00055	0°	055
C.MEG0006	0°	06
C.MEG0007	0°	07
C.MEG0008	0°	08
C.MEG1503	15°	03
C.MEG15035	15°	035
C.MEG1504	15°	04
C.MEG15045	15°	045
C.MEG1505	15°	05
C.MEG15055	15°	055
C.MEG1506	15°	06
C.MEG1507	15°	07
C.MEG1508	15°	08
C.MEG2503	25°	03
C.MEG25035	25°	035
C.MEG2504	25°	04
C.MEG25045	25°	045
C.MEG2505	25°	05
C.MEG25055	25°	055
C.MEG2506	25°	06
C.MEG2507	25°	07
C.MEG2508	25°	08
C.MEG4003	40°	03
C.MEG40035	40°	035
C.MEG4004	40°	04
C.MEG40045	40°	045
C.MEG4005	40°	05
C.MEG40055	40°	055

Nozzles

- H.p. nozzles, tip fitting Kärcher

H.p. nozzles , tip



Products of the highest quality, chosen and distributed by Club dei Riparatori to ensure the best value for money available today.

gr. 20
oz. 0.7

Code	Angle	Flow rate
DT.FUH11503	15°	03
DT.FUH115035	15°	035
DT.FUH11504	15°	04
DT.FUH115045	15°	045
DT.FUH11505	15°	05
DT.FUH115055	15°	055
DT.FUH11506	15°	06
DT.FUH115065	15°	065
DT.FUH11507	15°	07
DT.FUH115075	15°	075
DT.FUH11508	15°	08
DT.FUH12503	25°	03
DT.FUH125035	25°	035
DT.FUH12504	25°	04
DT.FUH125045	25°	045
DT.FUH12505	25°	05
DT.FUH125055	25°	055
DT.FUH12506	25°	06
DT.FUH125065	25°	065
DT.FUH12507	25°	07
DT.FUH125075	25°	075
DT.FUH12508	25°	08
DT.FUH140045	40°	045
DT.FUH14005	40°	05
DT.FUH140055	40°	055

CDR.7023

Tip retainer,
M 18x1 F



gr. 30
oz. 1.1

CDR.7024

Brass nozzle holder,
G 1/4" F-M 18x1 M



gr. 30
oz. 1.1

ZX.0154

Set O-Ring for brass nozzle holder
(code CDR.7024)

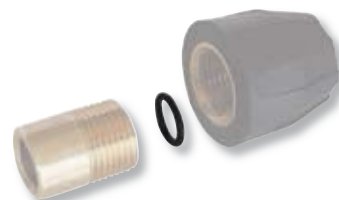

gr. 20
oz. 0.7

quantity
1x100



Nozzles

- Nozzle holder

The spare parts branded "CdR" exclusively refer to products by Club dei Riparatori® by IDROBASE®

ZX.7113

CdR 7 nozzle holder with black protection.
Made of zinced steel, inlet G 1/4" F, outlet 1/4" NPT-F.



gr. 45
oz. 1.6

ZX.7140

CdR 7 nozzle holder with blue protection.
Made of stainless steel, inlet G 1/4" F, outlet 1/4" NPT-F.



gr. 45
oz. 1.6

CDR.0359

Black rubber nozzle protection



gr. 20
oz. 0.7

CDR.7420

Nozzle holder coupling,
inlet G 1/4" F, outlet 1/4" NPT-F.



gr. 40
oz. 1.4

CDR.0364

Nozzle holder coupling,
inlet G 1/8" F, outlet 1/4" NPT-F.



gr. 40
oz. 1.4

Nozzles

- H.p. nozzles, "Quick"



Code	Angle	Flow rate
ES.NOQS-0003	0°	03
ES.NOQS-0003.5	0°	035
ES.NOQS-0004	0°	04
ES.NOQS-0004.5	0°	045
ES.NOQS-0005	0°	05
ES.NOQS-0005.5	0°	055
ES.NOQS-0006	0°	06
ES.NOQS-0007	0°	07
gr. 18 oz. 0.7	<i>H.p. quick nozzle 0° RED</i>	



Code	Angle	Flow rate
ES.NOQS-1503	15°	03
ES.NOQS-1503.5	15°	035
ES.NOQS-1504	15°	04
ES.NOQS-1504.5	15°	045
ES.NOQS-1505	15°	05
ES.NOQS-1505.5	15°	055
ES.NOQS-1506	15°	06
ES.NOQS-1507	15°	07
gr. 18 oz. 0.7	<i>H.p. quick nozzle 15° YELLOW</i>	



Code	Angle	Flow rate
ES.NOQS-2503	25°	03
ES.NOQS-2503.5	25°	035
ES.NOQS-2504	25°	04
ES.NOQS-2504.5	25°	045
ES.NOQS-2505	25°	05
ES.NOQS-2505.5	25°	055
ES.NOQS-2506	25°	06
ES.NOQS-2507	25°	07
gr. 18 oz. 0.7	<i>H.p. quick nozzle 25° GREEN</i>	



Code	Angle	Flow rate
ES.NOQS-4003	40°	03
ES.NOQS-4003.5	40°	035
ES.NOQS-4004	40°	04
ES.NOQS-4004.5	40°	045
ES.NOQS-4005	40°	05
ES.NOQS-4005.5	40°	055
ES.NOQS-4006	40°	06
ES.NOQS-4007	40°	07
gr. 18 oz. 0.7	<i>H.p. quick nozzle 40° WHITE</i>	



Code	Angle	Flow rate
ES.NOQB-6540	65°	40
gr. 18 oz. 0.7	<i>L.p. quick nozzle 65° BLACK</i>	



Code	Flow rate
ZX.0354	03
ZX.0310	035
ZX.0621	04
ZX.0293	045
ZX.0292	05
ZX.0343	055
ZX.0303	06
ZX.0304	07
gr. 195 oz. 6.9	<i>H.p. quick nozzles set</i>

CDR.7026

H.p. ball quick coupling, female, with rubber protection, inlet G 1/4" F, outlet "Quick", 250 bar-3600 psi, 30 l/min-8.00 USGpm, 90 °C-195 °F



gr. 70
oz. 2.5

CDR.7054

H.p. ball quick coupling, male, inlet "Quick", outlet G 1/4" F, 250 bar-3600 psi, 30 l/min-8.00 USGpm, 90 °C-195 °F



gr. 32
oz. 1.2

CDR.7055

H.p. ball quick coupling, male, inlet "Quick", outlet G 1/4" M, 250 bar-3600 psi, 30 l/min-8.00 USGpm, 90 °C-195 °F



gr. 31
oz. 1.2

Nozzles

- Rotating brush



gr. 890
oz. 31.2

*Inlet
G 1/4" M*

Code	Description
CDR.0056	Rotating brush with nylon bristle , nozzle hole ø3 mm. 40 bar-580 psi, 30 l/min-8.00 USGpm, 60 °C-140 °F



gr. 920
oz. 32.2

*Inlet
G 1/4" M*

Code	Description
CDR.0478	Rotating brush with horse hair bristle , nozzle hole ø3,5 mm. 40 bar-580 psi, 30 l/min-8.00 USGpm, 60 °C-140 °F

Nozzles

- L.p. nozzles

Made of brass



gr. 20
oz. 0.7

L.p. nozzles made of brass

Code	Inlet	Ang.	Nozzle
CDR.7290	1/4" NPT-M	65°	40
C.H1/8U-5020	1/8" NPT-M	50°	20
C.H1/8U-6550	1/8" NPT-M	65°	50
C.H1/4U-5020	1/4" NPT-M	50°	20
C.H1/4U-6550	1/4" NPT-M	65°	50



Nozzles - Adapter fitting kärcher

The spare parts branded "CdR" exclusively refer to products by Club dei Riparatori® by IDROBASE®

Nozzles adapter



Code	Description	Weight
ZX.7019	Brass adapter fitting Kärcher , inlet M 18x1 F, outlet G 1/4" M. It is ideal to mount inlet G 1/4" F nozzles on lances fitting Kärcher with connection M 18x1 M.	gr. 50 oz. 1.8

Nozzles

- Variable angle nozzle + Hi-Lo function

210 bar-3050 psi



Code	Nozzle	Description
CDR.0297	025	Variable angle nozzles with Hi-Lo function , inlet G 1/4" F, Max pressure 210 bar-3050 psi, Max temperature 150°C-300 °F.
CDR.0078	03	
CDR.0079	035	
CDR.0080	04	
CDR.0081	045	
CDR.0082	053	
CDR.0083	055	gr. 150 oz. 5.3

Nozzles

- Sand blast

Sand blast kit



Code	Nozzle	Description
P.25.0000.12	03	Professional sand blast kit . Complete with: brass head with WIDIA insert and painted steel probe. 250 bar-3600 psi, 40 l/min-10.50 USGpm.
P.25.0000.14	04	
P.25.0000.15	045	
P.25.0000.16	05	
P.25.0000.18	075	

Sand blast set



Code	Nozzle	Description
ZX.0517	03	Professional sand blast and painted steel probe set . Complete with: brass head with WIDIA insert, 4 m-13.10' suction hose, no. 1 stainless steel hose clip. Furnished already assembled. 250 bar-3600 psi, 40 l/min-10.50 USGpm.
ZX.0518	04	
ZX.0519	045	
ZX.0520	05	
ZX.0521	075	

Nozzles - Rotating

220 bar-3200 psi



Code	Nozzle	Description
G.003090151	035	Professional rotating nozzles Kränzle Dirtkiller. Inlet G 1/4" F, max pressure 220 bar-3200 psi, max temperature 70 °C-160 °F.
G.003090009	045	
G.003090131	055	
G.003090148	07	gr. 280 oz. 9.8

255 bar-3700 psi



Code	Nozzle	Description
CDR.0534	02	Professional rotating nozzles. Inlet G 1/4" F, max pressure 255 bar-3700 psi, max temperature 100 °C-210 °F.
CDR.0535	025	
CDR.0536	03	
CDR.0537	035	
CDR.0538	04	
CDR.0539	045	
CDR.0540	05	
CDR.0541	055	
CDR.0543	065	
CDR.0544	07	

255 bar-3700 psi



Code	Nozzle	Description
ZX.1060	02	Professional rotating nozzles. Ideal to be mounted on lances fitting Kärcher Inlet M 18x1 F, max pressure 255 bar-3700 psi, max temperature 100 °C-210 °F.
ZX.1061	025	
ZX.1062	03	
ZX.1063	035	
ZX.1064	04	
ZX.1065	045	
ZX.1066	05	
ZX.1067	055	
ZX.1069	065	
ZX.1070	07	

320 bar-4650 psi



Code	Nozzle	Description
G.003090049	045	Professional rotating nozzles Kränzle Turbokiller. Inlet G 1/4" F, max pressure 320 bar-4650 psi, max temperature 80 °C-175 °F.
G.003090006	055	
G.003090057	07	
G.003090084	08	
G.003090087	09	
G.003090119	10	

High pressure filters

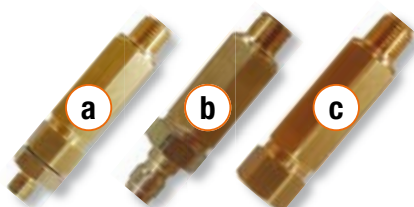

Code	Inlet	Outlet	Description
ZX.0785	G 1/4" M	G 1/4" M	High pressure filters. Made of brass, ideal to be mounted on the inlet of rotating nozzles. Max pressure 220 bar-3200 psi, max flow rate 30 l/min-8.00 USGpm.
ZX.0782	"Quick"	G 1/4" M	
CDR.0099	G 1/4" F	G 1/4" M	

Nozzles - Sewer

Sewer - G 1/8" F



Code	Nozzle	Description	
CDR.S18-040-4	040	Sewer nozzles, inlet G 1/8" F, no. 3+1 holes, max pressure 350 bar-5000 psi	
CDR.S18-045-4	045		
CDR.S18-055-4	055		
CDR.S18-065-4	065	gr. 6	oz. 0.3

Sewer - G 1/4" F



Code	Nozzle	Description	
CDR.S14-040-4	040	Sewer nozzles, inlet G 1/4" F, no. 3+1 holes, max pressure 350 bar-5000 psi	
CDR.S14-045-4	045		
CDR.S14-055-4	055		
CDR.S14-065-4	065	gr. 11	oz. 0.4

Professional sewer



Code	Nozzle	Description	
CDR.0365	04	Professional sewer nozzle, made of stainless steel, inlet G 1/4" M. no. 4 holes, 250 bar-3600 psi.	
		gr. 25	oz. 0.9
CDR.0366	06	Professional sewer nozzle, made of stainless steel, inlet G 3/8" M, no. 9 holes, 250 bar-3600 psi	
		gr. 36	oz. 1.3

Rotating sewer - G 1/8" F



Code	Nozzle	Description	
CDR.0508	040	Rotating sewer nozzles, inlet G 1/8" F, max pressure 250 bar-3600 psi	
CDR.0509	045		
CDR.0510	050		
CDR.0511	060	gr. 40	oz. 1.4

Rotating sewer - G 1/8" F



Code	Nozzle	Description	
CDR.0512	040	Rotating sewer nozzles, inlet G 1/8" F, max pressure 250 bar-3600 psi	
CDR.0513	045		
CDR.0514	050		
CDR.0515	060	gr. 62	oz. 2.2

Riparatori

Club dei
Riparatori®

Club dei
Riparatori®

OUR LINE OF SPRAY AND FOAM NEBULIZERS





For 20 years nebulization has been our expertise

Idrobase group is the oldest manufacturer of nebulizing systems in Europe. In fact, 20 years ago we started to produce industrial and professional nebulizers under the Idrobase brand. In 1995 as a result of our success we founded Idrotech Srl to produce nebulizers for industrial sectors (disinfection, odour neutralisation, dust suppression, cooling outside areas, humidifying), and in 2006 we founded Perfect Cool for cooling and humidifying in the commercial sector (restaurants, hotels, open areas, workshops, wine cellars, swimming pools, etc.), while in Idrobase we continue to develop detergent nebulizers for the car wash sector and food industry.

Idrobase: headquarters in Borgoricco - Padua ITALY



Club dei Riparatori presents the most innovative and complete range of professional detergent nebulizers present on the market.

- *Air nebulizer, 24 and 50 litres, in painted steel or stainless steel, both in spray and foam versions.*
- *Fixed system and wheeled electric nebulizers, in total-stop, possible to extend to two or more work stations.*
- *Venturi systems for high pressure washers, can be connected to the most common high pressure washers on the market.*



All of our nebulizers are designed, engineered and produced directly in our premises.

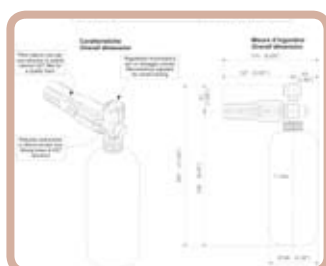



**Foam lances
- With tank**

The spare parts branded "CdR" exclusively refer to products by Club dei Riparatori® by IDROBASE®

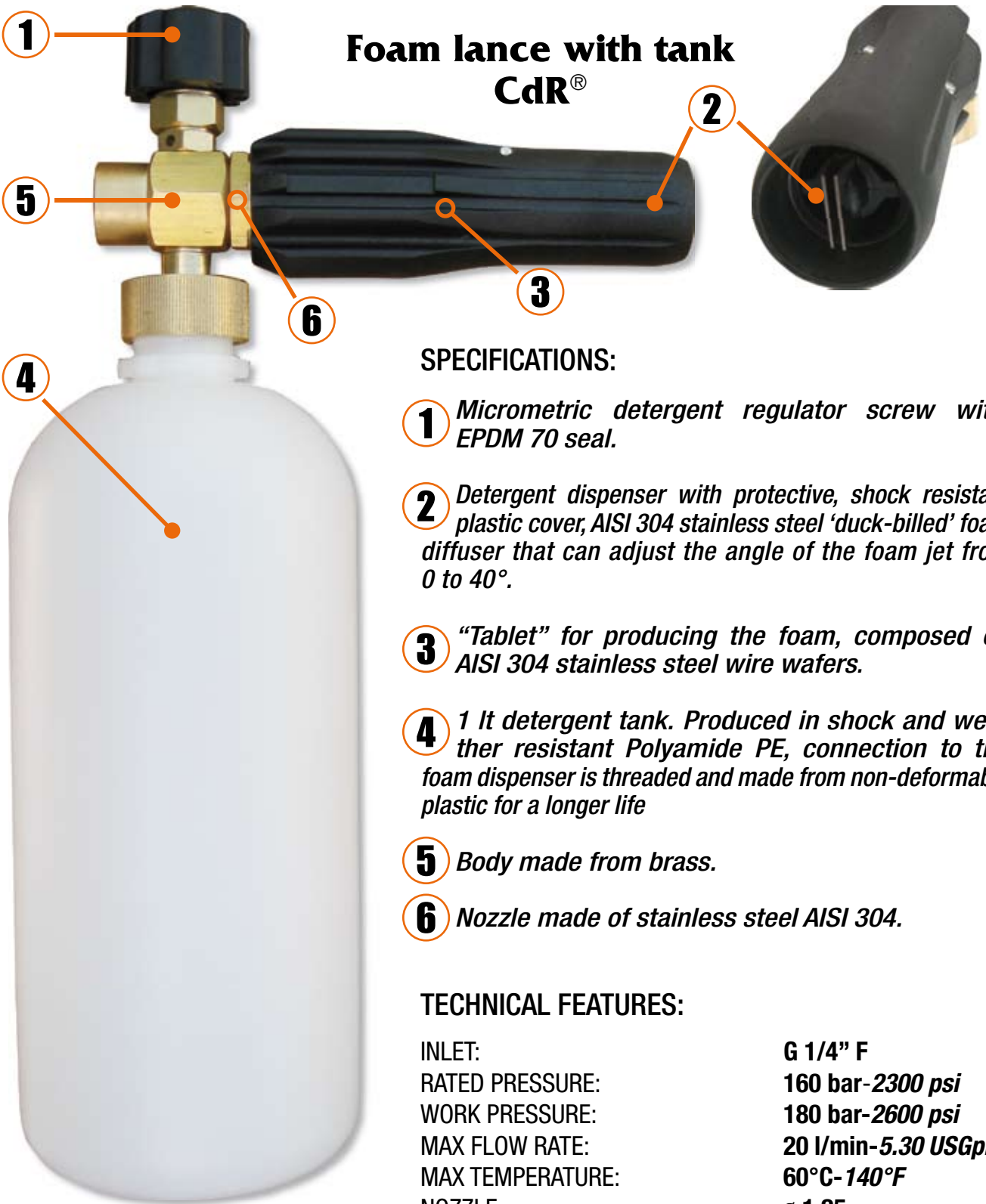

**Foam lance with tank
CdR®**

SPECIFICATIONS:

- 1** *Micrometric detergent regulator screw with EPDM 70 seal.*
- 2** *Detergent dispenser with protective, shock resistant plastic cover, AISI 304 stainless steel 'duck-billed' foam diffuser that can adjust the angle of the foam jet from 0 to 40°.*
- 3** *"Tablet" for producing the foam, composed of AISI 304 stainless steel wire wafers.*
- 4** *1 Lt detergent tank. Produced in shock and weather resistant Polyamide PE, connection to the foam dispenser is threaded and made from non-deformable plastic for a longer life*
- 5** *Body made from brass.*
- 6** *Nozzle made of stainless steel AISI 304.*

TECHNICAL FEATURES:

INLET:	G 1/4" F
RATED PRESSURE:	160 bar-2300 psi
WORK PRESSURE:	180 bar-2600 psi
MAX FLOW RATE:	20 l/min-5.30 USGpm
MAX TEMPERATURE:	60°C- 140°F
NOZZLE:	ø 1.25

Code	Description	Weight	
		gr.	oz.
CDR.0873	CdR foam lance with tank, capacity 1 lt-0.26 USG	560	19.6



Foam lances - Foam kit and accessories

The spare parts branded "CdR®" exclusively refer to products by Club dei Riparatori® by IDROBASE®

**Foam kit,
G 1/4" M connection**

ZX.0991

Foam kit composed of:
(a + b)
gr. 600 - oz. 21.0



**Foam kit,
quick connection**

ZX.0995

Foam kit composed of:
(c + d + e)
gr. 800 - oz. 28.0

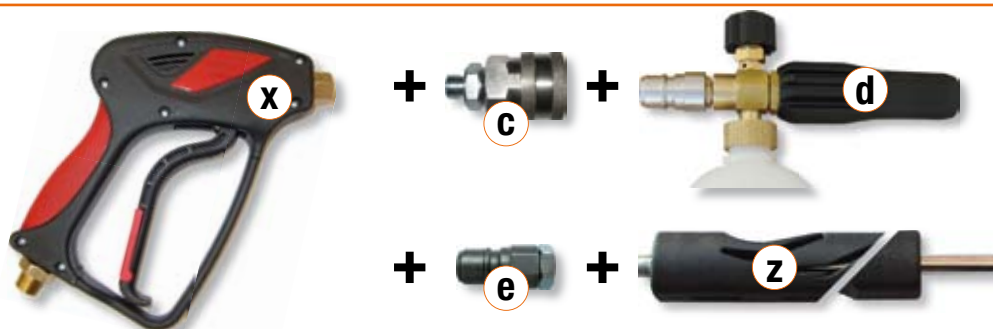

**Foam kit,
quick connection
fitting Kew**

ZX.0996

Foam kit composed of:
(f + g + h)
gr. 900 - oz. 31.5

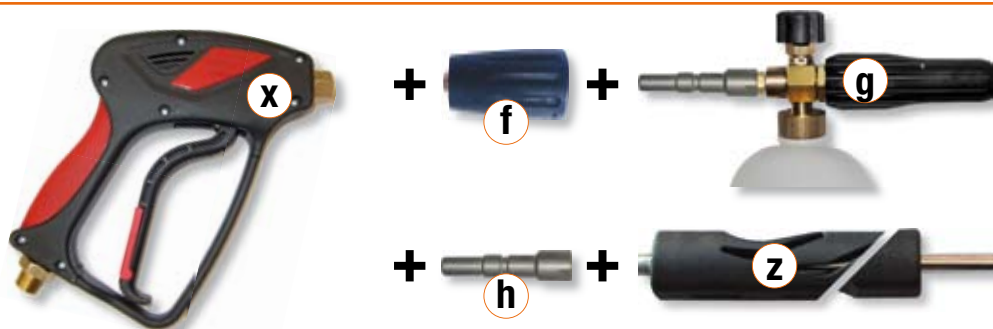

**Foam kit,
M 22x1,5 M connection**

ZX.0988

Foam lance,
with 1 lt-0.26 USG tank,
nozzle 1.25, inlet M 22x1,5 M
gr. 600 - oz. 21.0



Ref.	Code	Description	Weight
a	CDR.1277	L.p. brass nipple G 1/4" M-M	22 gr. 0.8 oz.
b	CDR.0873	Foam lance, with 1lt-0.26USG tank, nozzle 1.25	560 gr. 19.6 oz.
c	ZX.0987	Stainless steel AISI 416 h.p. ball quick coupling, inlet G 1/4" M, outlet quick F	160 gr. 5.6 oz.
d	ZX.0843	Foam lance, with 1lt-0.26USG tank, nozzle 1.25 + stainless steel AISI 416 quick M	600 gr. 21.0 oz.
e	ZX.0999	Stainless steel AISI 416 h.p. ball quick coupling, inlet quick M, outlet G 1/4" F	50 gr. 1.8 oz.
f	CDR.0001	H.p. ball quick coupling, inlet G 1/4" M, outlet quick F fitting Kew	240 gr. 8.4 oz.
g	ZX.0982	Foam lance, with 1lt-0.26USG tank, nozzle 1.25 + quick M fitting Kew	510 gr. 17.9 oz.
h	AB.0004	H.p. ball quick coupling, inlet quick M fitting Kew, outlet G 1/4" F	70 gr. 2.5 oz.
i	ZX.0988	Foam lance, with 1lt-0.26USG tank, nozzle 1.25 + inlet M 22x1,5 M	600 gr. 21.0 oz.
x	CDR.7404	CdR 990 spray gun, inlet G 3/8" F, outlet G 1/4" F	650 gr. 22.8 oz.
x	CDR.7407	CdR 990 spray gun, inlet M 22x1,5 M, outlet G 1/4" F	670 gr. 23.5 oz.
y	ZX.7103	CdR 990 spray gun with extension, inlet G 3/8" F, outlet M 22x1,5 F	1090 gr. 38.2 oz.
z	ZX.7106	CdR 55 vented handle lance, 500 mm-20", inlet G 1/4" M	475 gr. 16.7 oz.



Foam lances - Foam kit and accessories

The spare parts branded "CdR" exclusively refer to products by Club dei Riparatori® by IDROBASE®

**Foam kit fitting Kärcher,
M 22x1,5 F connection**

ZX.0992

Foam kit,
with 1 lt-0.26USG tank,
nozzle 1.25, inlet M 22x1,5 F
gr. 680 - oz. 23.8

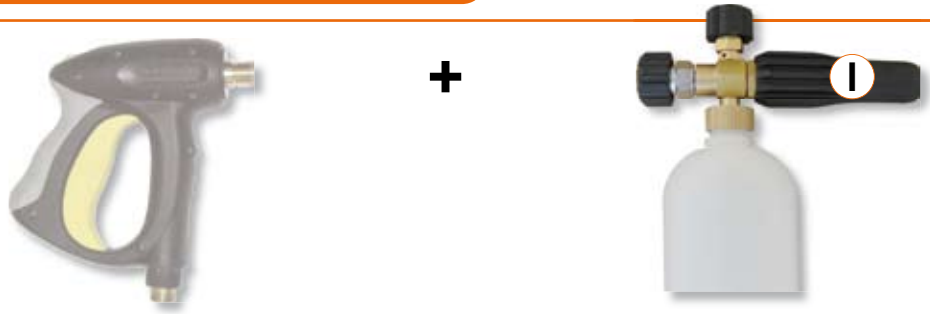

**Foam kit
fitting Kärcher,
quick connection**

ZX.0993

Foam kit composed of:
(p + d + r)
gr. 950 - oz. 33.3

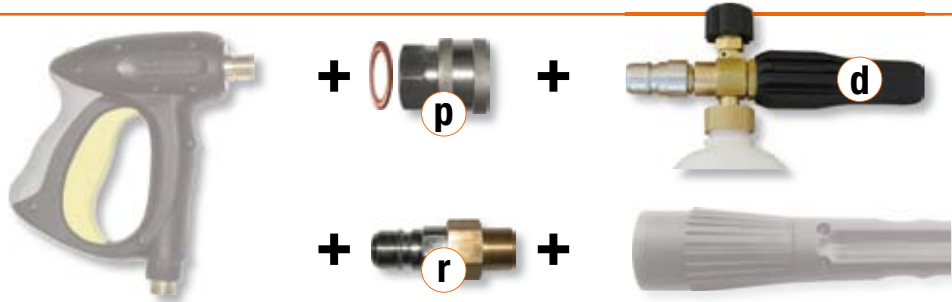

**Foam kit fitting Kärcher,
quick connection
fitting Kew**

ZX.0994

Foam kit composed of:
(s + g + u)
gr. 1150 - oz. 40.3

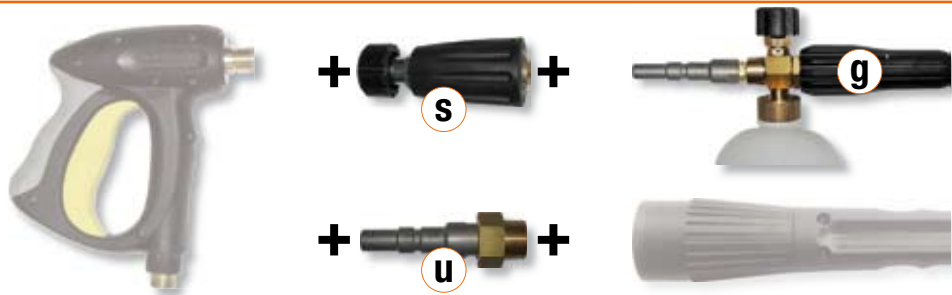

**Foam kit fitting Kärcher,
bayonet connection**

ZX.0986

Foam lance,
with 1 lt-0.26 USG tank,
nozzle 1.25, bayonet inlet
gr. 700 - oz. 24.5



**Foam kit fitting Kärcher,
bayonet connection**

ZX.0986-P

Foam lance,
with 1 lt-0.26 USG tank,
nozzle 1.25, bayonet inlet
gr. 650 - oz. 22.8



Ref.	Code	Description	Weight
I	ZX.0992	Foam lance, with 1lt-0.26USG tank, nozzle 1.25, inlet M 22x1,5 F	680 gr. 23.8 oz.
p	ZX.1045	Stainless steel AISI 416 h.p. ball quick coupling, inlet M 22x1,5 F, outlet quick F + copper washer	150 gr. 5.3 oz.
d	ZX.0843	Foam lance, with 1lt-0.26USG tank, nozzle 1.25 + stainless steel AISI 416 quick M	600 gr. 21.0 oz.
r	ZX.0842	H.p. ball quick coupling, inlet SS AISI 416 quick F, outlet brass M 22x1,5 F connection	200 gr. 7.0 oz.
s	ZX.0980	H.p. ball quick coupling, inlet M 22x1,5 F, outlet quick F fitting Kew	360 gr. 12.6 oz.
g	ZX.0982	Foam lance, with 1lt-0.26USG tank, nozzle 1.25 + quick M fitting Kew	510 gr. 17.9 oz.
u	ZX.0981	H.p. ball quick coupling, inlet quick M fitting Kew, outlet M 22x1,5 M	200 gr. 7.0 oz.
m	ZX.0986	Foam lance, with 1lt-0.26USG tank, nozzle 1.25 + quick brass bayonet	700 gr. 24.5 oz.
n	ZX.0986-P	Foam lance, with 1lt-0.26USG tank, nozzle 1.25 + quick plastic bayonet	650 gr. 22.8 oz.



Nebulizers - Air, spray and foam / PAINTED STEEL

The spare parts branded "CdR" exclusively refer to products by Club dei Riparatori® by IDROBASE®



CdR® painted steel nebulizers 24 lt-6.35 USG and 50 lt-13.20 USG

CdR® nebulizers Airspray (code 8.2002 and 8.2003) and Airfoam (code 8.2004 and 8.2005) are made from 2,5 mm-0.1" painted steel 360 S235JR. Recommended for professional use and comes complete with:

Airspray: gun (with internal parts Viton + SS), 600 mm-23.64" (8.2002) and 900 mm-35.43" (8.2003) lance with brass spray nozzle, pressure gauge, safety valve, ball valve, 10 m-32.80' Rilsan spiral hose with anti-twist connection.

Airfoam: gun (with internal parts Viton + SS), 600 mm-23.64" (8.2004) and 900 mm-35.43" (8.2009) lance with 4 brass foam nozzles, pressure gauge, safety valve, manual release valve and air pressure regulator, air suction valve, detergent suction valve, ball valve, 10 m-32.80' nylon hose.

Max pressure, 8 bar-115 psi.

ATTENTION !!! Not suitable for use with aggressive chemicals, inflammable liquids and / or detergents with a different ph than 5.

Code	Model	Type	Capacity	Material	Weight
8.2002	Airspray	spray	24 lt - 6.35 USG	Painted steel	14500 gr. 507.5 oz.
8.2004	Airfoam	foam	24 lt - 6.35 USG	Painted steel	16000 gr. 560.0 oz.
8.2003	Airspray	spray	50 lt - 13.20 USG	Painted steel	26000 gr. 910.0 oz.
8.2009	Airfoam	foam	50 lt - 13.20 USG	Painted steel	27000 gr. 945.0 oz.

Painted steel nebulizers are also available in yellow.



Nebulizers
- Air, spray and foam / STAINLESS STEEL

The spare parts branded "CdR" exclusively refer to products by Club dei Riparatori® by IDROBASE®



Spray

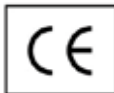

Foam

CdR® stainless steel AISI 304 nebulizers 24 lt-6.35 USG and 50 lt-13.20 USG

CdR® Airspray SS (code 8.2007 and 8.2008) and Airfoam SS (code 8.2006 and 8.2005) are made of stainless steel AISI 304. Recommended for professional use and comes complete with:

Airspray: gun (with internal parts Viton + SS AISI 316), 600 mm-23.64" (8.2007) and 900 mm-35.43" (8.2008) lance with brass spray nozzle, pressure gauge, safety valve, ball valve, 10 m-32.80' Rilsan spiral hose with anti-twist connection.

Airfoam: gun (with internal parts Viton + INOX), 600 mm-23.64" (8.2006) and 900 mm-35.43" (8.2005) lance with 4 brass foam nozzles, pressure gauge, safety valve, manual release valve and air pressure regulator, air suction valve, detergent suction valve, ball valve, 10 m-32.80' nylon hose.

Max pressure, 8 bar-115 psi.

ATTENTION !!! Not suitable for use with aggressive chemicals, inflammable liquids and / or detergents with a different ph than 5.

Code	Model	Type	Capacity	Material	Weight
8.2007	Airspray SS	spray	24 lt - 6.35 USG	SS AISI 304	11300 gr. 395.5 oz.
8.2006	Airfoam SS	foam	24 lt - 6.35 USG	SS AISI 304	12700 gr. 444.5 oz.
8.2008	Airspray SS	spray	50 lt - 13.20 USG	SS AISI 304	21000 gr. 735.0 oz.
8.2005	Airfoam SS	foam	50 lt - 13.20 USG	SS AISI 304	22500 gr. 787.5 oz.

FIX SYSTEM electric nebulizer

Recommended for intensive use, completely silent
It includes:

- **Pump** with blades, body of the pump and pump shaft in stainless steel AISI 303, stator, flanges and blades in graphite, seals and O-Rings in Viton, by-pass valve in polycarbonate and nylon 6.6
- **Electric Motor** IP54 complete with ON-OFF switch
- **Total-Stop device**, operated directly by the trigger of the gun
- **Pressure gauge**, **3 m-9.85' electric cable** complete with Schuko plug
- **Suction** of chemical product: 1200 mm-47" Nylon hose, with check valve and 100 micron filter in stainless steel AISI 303
- 10 m-32.80' **PVC Hose**, flexible
- 100 lt-26.40 **USG detergent tank** complete with quantity of product sensor
- Automatic pump **stop device**, in case of shortage of product to nebulize
- **Lance** holder, stainless steel
- **Plastic Gun**, with seals in Viton, stainless steel AISI 316 ball and spring
- **Lance** for Fixed Elettrospray with 600mm-23.64" stainless steel hose and fan-shaped 40° brass nozzle
- **Lance** for Fixed Elettrofoam with 600 mm-23.64" stainless steel hose and head with 4 fan-shaped 65° nozzles
- **Foam regulator set** for Fixed Elettrofoam: simple device to mix the air from the compressor (not supplied) with the chemical product to be nebulized, comes complete with pressure gauge and air regulator



Code	Model	Pressure	Flow rate	Voltage	Frequency	Power	Dimensions (W x L x H)	Weight
ZX.1136	FIXED ELETTOSPRAY	8 bar 115 psi	80 lt/h 21.0 USGph	1x230 V	50 Hz	190 W	650 x 500 x 1500 mm 25.60" x 19.70" x 59.10"	24000 gr. 840.0 oz.
ZX.1137	FIXED ELETTROFOAM	6-7 bar 85-100 psi	80 lt/h 21.0 USGph	1x230 V	50 Hz	190 W	650 x 500 x 1500 mm 25.60" x 19.70" x 59.10"	29000 gr. 1,015.0 oz.

ATTENTION !!!

Not suitable for use with aggressive chemicals, inflammable liquids and / or detergents with a different ph than 5.

WHEELED electric nebulizer

Recommended for intensive use, completely silent
Includes:

- **Frame**, in painted steel,
- **Pump** with blades, body of the pump and pump shaft in stainless steel AISI 303, stator, flanges and blades in graphite, seals and O-Rings in Viton, by-pass valve in polycarbonate and nylon 6.6
- **Electric Motor** IP54 complete with ON-OFF switch
- **Total-Stop device**, operated directly by the trigger of the gun
- **Pressure gauge**, **3 m-9.85' electric cable** complete with Schuko plug
- **Suction** of chemical product: 1200 mm-47" Nylon hose, with check valve and 100 micron filter in stainless steel AISI 303
- 10 m-32.80' **PVC Hose**, flexible
- 25 lt detergent **tank** complete with quantity of product sensor
- Automatic pump **stop device**, in case of shortage of product to nebulize
- **Lance** holder, stainless steel
- **Plastic Gun**, with seals in Viton, stainless steel AISI 316 ball and spring
- **Lance** for wheeled Elettrospray with 600 mm-23.64" stainless steel hose and fan-shaped 40° brass nozzle
- **Lance** for wheeled Elettrofoam with 600 mm-23.64" stainless steel hose and head with 4 fan-shaped 65° nozzles
- **Foam regulator set** for Fixed Elettrofoam: simple device to mix the air from the compressor (not supplied) with the chemical product to be nebulized, comes complete with pressure gauge and air regulator



Code	Model	Pressure	Flow rate	Voltage	Frequency	Power	Dimensions (W x L x H)	Weight
ZX.1139	ELETTROSPRAY	8 bar 115 psi	80 lt/h 21.0 USGph	1x230 V	50 Hz	190 W	650 x 500 x 1500 mm 25.60" x 19.70" x 59.10"	21000 gr. 735.0 oz.
ZX.1138	ELETTROFOAM	6-7 bar 85-100 psi	80 lt/h 21.0 USGph	1x230 V	50 Hz	190 W	650 x 500 x 1500 mm 25.60" x 19.70" x 59.10"	23500 gr. 822.5 oz.

ATTENTION !!!

**Not suitable for use with aggressive chemicals, inflammable liquids
and / or detergents with a different ph than 5.**

Foam kit for fixed high pressure washer system

1 High pressure foam system is a high pressure foam dispenser, very compact and in **combination with the foaming lance** can be operated very economically with minimum detergent use.

- Aspiration system: Venturi
- Water flow rate: 80 bar-1160 psi ÷ 11 l/min-2.90 USGpm, 100 bar-1450 psi ÷ 12,4 l/min-3.27 USGpm, 120 bar-1750 psi ÷ 13,5 l/min-3.56 USGpm, 150 bar-2200 psi ÷ 15 l/min-4.00 USGpm
- Maximum pressure: 200 bar-2900 psi
- Maximum temperature: 95 °C-195 °F
- Area treated per minute: about 70 m²-83.70 sq yds.
- Percentage of foam detergent aspirated: 0.1 to 10 %.
- Device dimensions: 150-5.91"x125-4.92"x50-1.97" mm (WxHxL).
- Device weight: about 3 kg-6.60 lbs.
- Device material: stainless steel AISI 304.
- Venturi system material: stainless steel AISI 316.

Standard accessories

- Two quick connections.
- 1500 mm-59" suction hose.
- Stainless steel dosage regulator.

2 Gun CdR 990 for continuous use, ergonomic design, with soft rubber grip.

3 Stainless steel foam lance covered in shock proof plastic, supplied with suitable device for the production of foam and with nebulizing fan nozzle. Complete with male bayonet fitting KEW.

Use

Ideal for all high pressure water systems from 100 bar-1450 to 200 bar-2900 psi. The connection of the dosage unit allows for economical and efficient results with minimal detergent consumption.

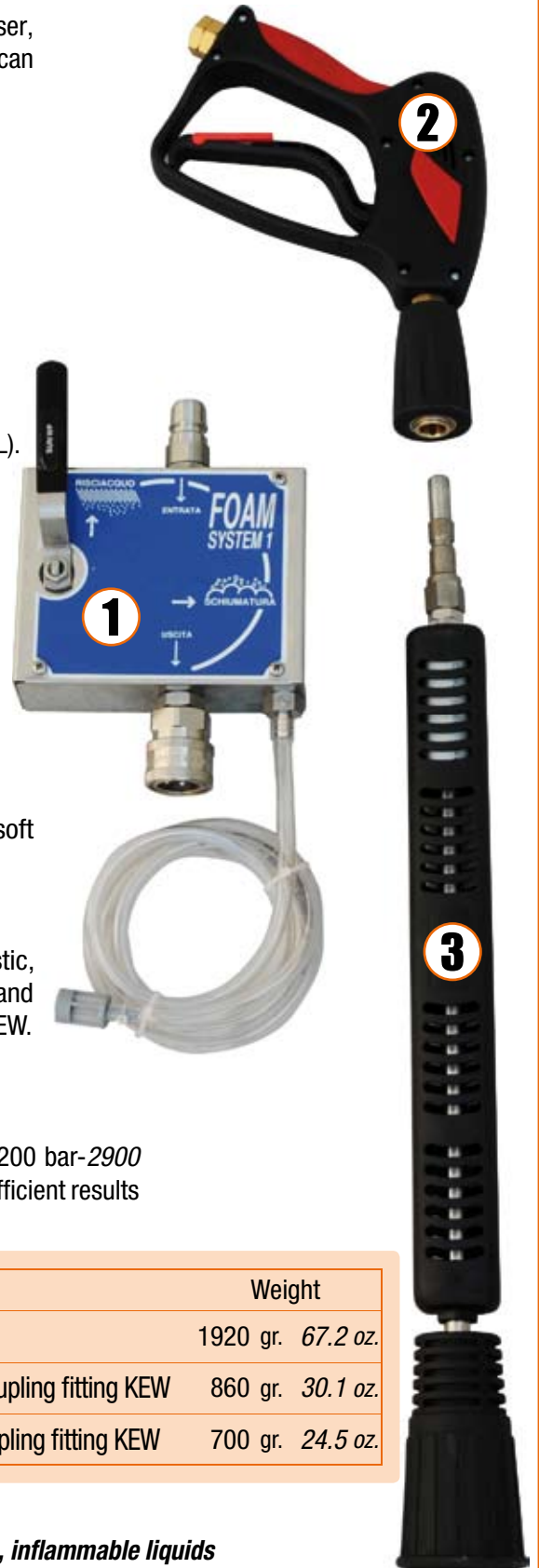

	Code	Description	Weight
1	CDR.1269	High pressure foam system	1920 gr. 67.2 oz.
2	ZX.1134	Gun CdR 990 inlet 3/8F, outlet female coupling fitting KEW	860 gr. 30.1 oz.
3	ZX.1135	Foam lance, 510mm-20", with male coupling fitting KEW	700 gr. 24.5 oz.

ATTENTION !!!

Not suitable for use with aggressive chemicals, inflammable liquids and / or detergents with a different ph than 5.



Nebulizers - Accessories

The spare parts branded "CdR" exclusively refer to products by Club dei Riparatori® by IDROBASE®

CDR.0754
Spray gun for nebulizer
BLUE trigger,
 G 1/2" F-F,
 body:
 plastic,
 inner parts:
 Viton + SS,
 ball-spring:
 SS-SS



gr. 120
oz. 4.2

25 bar, 70 l/min, 50 °C

CDR.0755
Spray gun for nebulizer
GREY trigger,
 G 1/2" F-F,
 body:
 plastic,
 inner parts:
 Viton + AISI 316,
 ball-spring:
 AISI 316-AISI 316



gr. 120
oz. 4.2

25 bar, 70 l/min, 50 °C

CDR.0757
Inlet filter
 for nebulizer spray gun,
 filtering capacity 25 mesh,
 body:
 plastic



gr. 45
oz. 1.6

40 bar, 70 l/min, 60 °C

CDR.0758
Lance in PVC
600 mm-23.7",
 inlet G 1/2" F,
 complete with:
 blue trigger
 spray gun,
 plastic
 flat-fan nozzle
 ø1,1 mm



gr. 240
oz. 8.4

25 bar-360 psi,
30 l/min-8.00 USGpm,
50 °C-120 °F

CDR.0759
Lance in PVC
1200 mm-47.3",
 inlet G 1/2" F,
 complete with:
 blue trigger
 spray gun,
 plastic
 flat-fan nozzle
 ø1,1 mm



gr. 330
oz. 11.7

25 bar-360 psi,
30 l/min-8.00 USGpm,
50 °C-120 °F

CDR.0760
Lance
in stainless steel
600 mm-23.7",
 inlet G 1/2" F,
 complete with:
 blue trigger
 spray gun,
 stainless steel
 cone nozzle ø1,2 mm



gr. 320
oz. 11.3

15 bar-215 psi,
30 l/min-8.00 USGpm,
50 °C-120 °F

CDR.0552
Lance
in stainless steel
1500 mm-59.1",
 inlet G 1/2" F,
 complete with:
 blue trigger
 spray gun, brass
 flat-fan nozzle
 ø1,1 mm



gr. 730
oz. 25.8

25 bar-360 psi,
30 l/min-8.00 USGpm,
50 °C-120 °F

Code	ø Nozzle	Colour
 CDR.0764	1,1 mm	BLUE
CDR.0765	1,4 mm	BROWN
CDR.0766	1,8 mm	WHITE

gr. 1
oz. 0.1

Flat-fan spray nozzle, made of plastic,
angle 110° (minimum quantity 5 pcs)

CDR.0767
Flat-fan spray nozzle,
 made of stainless steel,
 angle 110°



gr. 7
oz. 0.3

minimum
quantity 5 pcs

CDR.7569
Flat-fan spray nozzle,
 made of brass,
 angle 40°,
 flow rate 04



gr. 3
oz. 0.2

CDR.0768
Flat-fan foam nozzle,
 made of plastic,
 angle 60°,
 3 bar-45psi,
 9,8 l/min-2.55 USGpm



gr. 80
oz. 2.8

CDR.0769
Flat-fan foam head,
 made of plastic,
 flow rate 04



gr. 25
oz. 0.9

CDR.0770
Filter for nozzles,
 made of stainless steel,
 and Viton seal,
 50 mesh



gr. 1
oz. 0.1

minimum
quantity 10 pcs

CDR.0771
Plastic reducer,
 G 3/8" M - G 1/4" F



gr. 3
oz. 0.2

minimum
quantity 10 pcs

CDR.0772
Seal for nozzle



gr. 3
oz. 0.2

minimum
quantity 10 pcs

CDR.0773
Plastic nozzle jolder,
 G 3/8" F



gr. 5
oz. 0.2

minimum
quantity 10 pcs

CDR.7623
Complete head for
spray nebulizers



gr. 100
oz. 3.5

CDR.7629
Complete head for
foam nebulizers,
 inlet G 1/4" F,
 complete with:
 4 brass nozzles



gr. 300
oz. 10.6

CDR.7551
Head for foam nebulizer,
 without nozzles,
 inlet G 1/4" F,
 outelt 4 x G1/8" F



gr. 100
oz. 3.5

CDR.7550
Foam nozzle,
 made of brass
 inlet G 1/8" M,
 angle 60°,
 flow rate
 10



gr. 30
oz. 1.1



Nebulizers - Accessories

The spare parts branded "CdR" exclusively refer to products by Club dei Riparatori® by IDROBASE®

CDR.7571

Rilsan spiral hose,
ø8x6 mm-0.31"x0.24",
G 1/4" M-G 1/4" M swivel,
10 m-32.80 ft,



gr. 300
oz. 23.7

CDR.7549

Flexible braided PVC hose
with connections, ø8x13 mm-0.31"x0.51",
bayonet connections,
10 m-32.80 ft



gr. 1500
oz. 9.6

CDR.7213

Ball valve,
G 1/4" M-F



gr. 60
oz. 2.2

ZX.1146

Air pressure regulator,
0-8 bar / 0-116 psi,
with bayonet connections



gr. 160
oz. 5.6

CDR.7543

Safety valve for compressed air,
G 1/8" M, calibration: 8 bar-116 psi,
NBR seals



gr. 30
oz. 1.1

CDR.7634

Pressure gauge ø40 mm,
made of stainless steel AISI 304
back entry 1/8" M-BSPT,
0-12 bar / 0-170 psi



gr. 100
oz. 3.5

CDR.7527

Wheel for nebulizer
24 litres-6.33 USG,
made of black rubber,
ø15 mm-0.59"



gr. 300
oz. 10.5

CDR.7529

Stop disc,
made of stainless steel,
for wheel of nebulizer
24 litres-6.33 USG



gr. 20
oz. 0.7

CDR.7619

Wheel for nebulizer
50 litri-13.20 USG,
made of black rubber,
ø20 mm-0.79"



gr. 500
oz. 17.5

CDR.7630

Stop disc,
made of stainless steel,
for wheel of nebulizer
50 litres-13.20 USG



gr. 20
oz. 0.7

CDR.0788

Brass blade pump,
10 bar-145 psi,
100 l/h-0.44 USGph



gr. 1350
oz. 47.3

Complete with fixing clamp

CDR.0789

Stainless steel blade pump,
10 bar-145 psi,
100 l/h-0.44 USGph



gr. 1350
oz. 47.3

Complete with fixing clamp

CDR.0787

Electric motor,
for blade pump
240 V-50 Hz, 187 W, IP54



gr. 4350
oz. 152.3



Particular
of the
hollow
shaft

IMPORTANT:

- The pump does NOT work without liquid
- It is better to use a filter, at the inlet of the pump.
- Avoid operating at temperatures lower than 8 °C-46 °F
- At the end of work it is important to clean the pump with water

Electric components

CDR.0746

Total-Stop device,
for COLD
high pressure washers,
up to 3 HP,
230 V-50/60 Hz



Temporised Total-Stop device is equipped with a transformer which makes it autonomous. It's ideal for h.p. washers mono-phase 230 V, 50-60 Hz. It performs the temporised take-off of the electric motor (5sec.). It has CE homologation and it is supplied with the assembly scheme.

gr. 320
oz. 11.3

ATTENTION ! It has to be settled with an unloader valve (WITHOUT pressure reduction) and 2 pressure switches.

CDR.0747

Total-Stop device,
for COLD
high pressure washers,
up to 5,5 HP,
400 V-50/60 Hz



Temporised Total-Stop device is equipped with a transformer which makes it autonomous. It's ideal for h.p. washers three-phase 400 V, 50-60 Hz. It performs the temporised take-off of the electric motor (15 sec.). It has CE homologation and it is supplied with the assembly scheme.

gr. 370
oz. 13.1

ATTENTION ! It has to be settled with an unloader valve (WITHOUT pressure reduction) and 2 pressure switches.

CDR.0748

Total-Stop device,
for COLD and/or HOT
high pressure washers,
up to 7,5 HP,
230-400 V-50/60 Hz



Temporised Total-Stop device is equipped with a transformer which makes it autonomous. It can be supplied with high tension 230 V or 400 V at 50-60 Hz. It performs the temporised take-off of the electric motor (15 sec.) and the delayed restart of the burner motor (3 sec.). It has CE homologation and it is supplied with the assembly scheme.

gr. 450
oz. 15.9

ATTENTION ! It is to be settled with an unloader valve (WITHOUT pressure reduction) and 2 pressure switches.

CDR.0749

Total-Stop device,
for COLD and/or HOT
high pressure washers,
up to 10 HP,
230-400 V-50/60 Hz



gr. 1500
oz. 53.0

ATTENTION ! It is to be settled with an unloader valve (WITHOUT pressure reduction) and 2 pressure switches.



Code	Ampere	Description
CDR.0716	10	Thermal switches, mono-phase 2 poles 240 V
CDR.0717	14	hole: 4,5x22mm 0.18"x0,87"
CDR.0718	16	gr. 30 oz. 1.1



Code	Ampere	Description
CDR.0721	10	Thermal switches, three-phase, 3 poles, 415 V
CDR.0722	12	hole: 5,0x45mm 0.20"x1.77"
CDR.0723	14	
CDR.0724	16	gr. 75 oz. 2.7



Code	Ampere	Description
CDR.0750	10-16	Thermal overload switches, three-phase, 3 poles, 690 V
CDR.0751	16-20	
CDR.0752	20-25	gr. 250 oz. 8.9

CDR.0719
Water splash protection
for mono-phase
thermal switch



gr. 6
oz. 0.3

CDR.0720
Frame
for water splash
protection



gr. 10
oz. 0.4

CDR.0753
Water splash protection kit IP54,
for ISKRA
thermal overload
switches

















gr. 20
oz. 0.7



Quick coupling - Ball quick couplings

The spare parts branded "CdR" exclusively refer to products by Club dei Riparatori® by IDROBASE®

<p>CDR.7009 H.p. ball quick coupling, male, made of tropicalized steel, inlet G 3/8" F, 250 bar-3600 psi</p>  <p>gr. 50 oz. 1.8</p>	<p>CDR.7010 H.p. ball quick coupling, female, made of chromed brass, inlet G 3/8" F, 250 bar-3600 psi</p>  <p>gr. 170 oz. 6.0</p> <p>8 Spheres 3 O-Rings</p>	<p>CDR.7160 H.p. ball quick coupling, male, made of tropicalized steel, inlet G 3/8" M, 250 bar-3600 psi</p>  <p>gr. 75 oz. 2.7</p>	<p>CDR.7161 H.p. ball quick coupling, female, made of chromed brass, inlet G 3/8" M, 250 bar-3600 psi</p>  <p>gr. 180 oz. 6.4</p> <p>8 Spheres 3 O-Rings</p>	
<p>CDR.7011 H.p. ball quick coupling, male, made of stainless steel AISI 416, inlet G 3/8" F, 250 bar-3600 psi</p>  <p>gr. 50 oz. 1.8</p>	<p>CDR.7012 H.p. ball quick coupling, female, made of stainless steel AISI 416, inlet G 3/8" F, 250 bar-3600 psi</p>  <p>gr. 160 oz. 5.7</p> <p>8 Spheres 3 O-Rings</p>	<p>CDR.7377 H.p. ball quick coupling, female, made of stainless steel AISI 416, inlet M 22x1,5 F, 250 bar-3600 psi</p>  <p>gr. 160 oz. 5.7</p> <p>8 Spheres 3 O-Rings</p>	<p>B.MS38AP H.p. ball quick coupling, male, made of zinc plated carbon steel, inlet G 3/8" F, 250 bar-3600 psi</p>  <p>gr. 75 oz. 2.7</p>	<p>B.FS38AP H.p. ball quick coupling, female, made of chromed brass, inlet G 3/8" F, 250 bar-3600 psi</p>  <p>gr. 170 oz. 6.0</p> <p>10 Spheres 1 O-Ring</p>
<p>CDR.0013 H.p. ball quick coupling, male, MIDI, made of brass, inlet M 22x1,5 F, 250 bar-3600 psi</p>  <p>gr. 95 oz. 3.4</p>	<p>CDR.0014 H.p. ball quick coupling, male, MIDI, made of tropicalized steel, inlet G 3/8" F, 250 bar-3600 psi</p>  <p>gr. 45 oz. 1.6</p>	<p>CDR.0015 H.p. ball quick coupling, female, MIDI, made of brass, inlet M 22x1,5 M, 250 bar-3600 psi</p>  <p>gr. 105 oz. 3.7</p> <p>8 Spheres 1 O-Ring</p>	<p>CDR.0016 H.p. ball quick coupling, female, MIDI, made of brass, inlet G 3/8" F, 250 bar-3600 psi</p>  <p>gr. 105 oz. 3.7</p> <p>8 Spheres 1 O-Ring</p>	
<p>CDR.7103 H.p. ball quick coupling, female, MIDI, made of brass with black rubber protection, inlet G 3/8" F, 250 bar-3600 psi</p>  <p>gr. 70 oz. 2.5</p> <p>8 Spheres 1 O-Ring</p>	<p>CDR.0012 H.p. ball quick coupling, male, MIDI, made of stainless steel, inlet G 3/8" F, 250 bar-3600 psi</p>  <p>gr. 45 oz. 1.6</p>	<p>CDR.0011 H.p. ball quick coupling, female, MIDI, made of stainless steel, inlet G 3/8" F, 250 bar-3600 psi</p>  <p>gr. 100 oz. 3.6</p> <p>8 Spheres 1 O-Ring</p>	<p>CDR.7095-G H.p. ball quick coupling, female, MIDI, made of stainless steel, inlet G 3/8" M, 345 bar- 5000 psi</p>  <p>gr. 100 oz. 3.6</p> <p>8 Spheres 1 O-Ring</p>	



Quick coupling - Screw quick coupling M 22

The spare parts branded "CdR®" exclusively refer to products by Club dei Riparatori® by IDROBASE®

Nipple M 22x1,5 M ø14

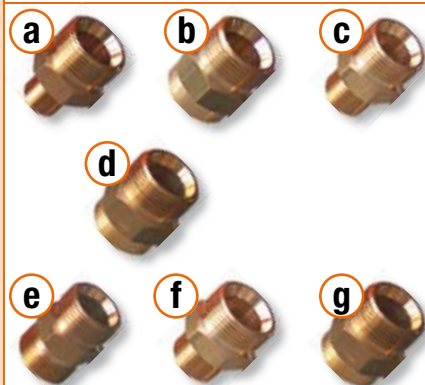

Code	Inlet	Weight	Description
a) CDR.7111	G 1/4" M	gr. 50 oz. 1.8	Nipples M 22x1,5 M ø14. Made of brass. Pressure 250 bar-3600 psi, temperature 150°C-300°F, flow rate 40 l/min-10.50 USGpm.
b) CDR.7016	G 1/4" F	gr. 45 oz. 1.6	
c) CDR.7017	G 3/8" M	gr. 55 oz. 2.0	
d) CDR.7015	G 3/8" F	gr. 50 oz. 1.8	
e) CDR.7112	M 22x1,5 M	gr. 60 oz. 2.2	
f) MV.0212003610	G 1/2" M	gr. 50 oz. 1.8	
g) MV.0212003600	G 1/2" F	gr. 50 oz. 1.8	

Screw coupling M 22x1,5 F ø14

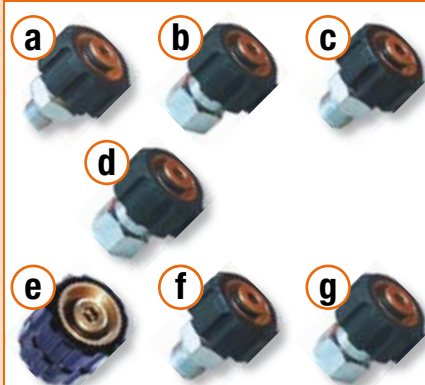

Code	Inlet	Weight	Description
a) CDR.7108	G 1/4" M	gr. 120 oz. 4.3	Screw quick couplings M 22x1,5 F ø14. Made of chromed brass, with 1 O-Ring inside. Pressure 250 bar-3600 psi, temperature 150°C-300°F, flow rate 40 l/min-10.50 USGpm.
b) CDR.7107	G 1/4" F	gr. 115 oz. 4.1	
c) CDR.7014	G 3/8" M	gr. 120 oz. 4.3	
d) CDR.7013	G 3/8" F	gr. 115 oz. 4.1	
e) CDR.0010	M 22x1,5 F	gr. 120 oz. 4.3	
f) MV.0212003510	G 1/2" M	gr. 125 oz. 4.5	
g) MV.0212003500	G 1/2" F	gr. 130 oz. 4.6	

Nipple M 22x1,5 M ø15

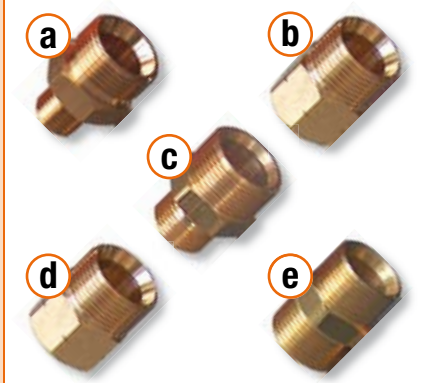

Code	Inlet	Weight	Description
a) CDR.7226	G 1/4" M	gr. 50 oz. 1.8	Nipples M 22x1,5 M ø15. Made of brass. Pressure 250 bar-3600 psi, temperature 150°C-300°F, flow rate 40 l/min-10.50 USGpm.
b) CDR.7224	G 1/4" F	gr. 45 oz. 1.6	
c) CDR.7225	G 3/8" M	gr. 55 oz. 2.0	
d) CDR.7223	G 3/8" F	gr. 50 oz. 1.8	
e) CDR.7227	M 22x1,5 M	gr. 60 oz. 2.2	

Screw coupling M 22x1,5 F ø15

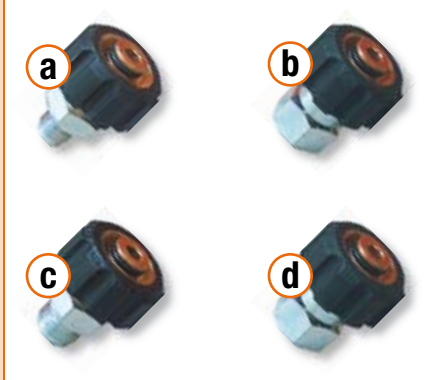

Code	Inlet	Weight	Description
a) CDR.7231	G 1/4" M	gr. 120 oz. 4.3	Screw quick couplings M 22x1,5 F ø15. Made of chromed brass, with 1 O-Ring inside. Pressure 250 bar-3600 psi, temperature 150°C-300°F, flow rate 40 l/min-10.50 USGpm.
b) CDR.7229	G 1/4" F	gr. 115 oz. 4.1	
c) CDR.7230	G 3/8" M	gr. 120 oz. 4.3	
d) CDR.7228	G 3/8" F	gr. 115 oz. 4.1	



Quick coupling - Swivel screw quick coupling

The spare parts branded "CdR" exclusively refer to products by Club dei Riparatori® by IDROBASE®

Nipple G 1/2" M

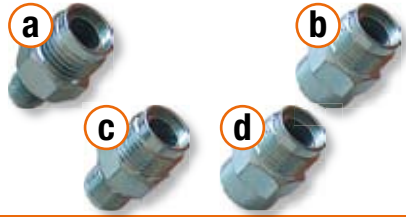

Code	Inlet	Weight	Description
a) MV.0212000150	G 1/4" M	gr. 60 oz. 2.1	Nipples G 1/2" M. Made of chromed brass, with 1 O-Ring inside. Pressure 250 bar-3600 psi, flow rate 40 l/min-10.50 USGpm, temperature 150 °C-300 °F.
b) MV.0212000130	G 1/4" F	gr. 60 oz. 2.1	
c) MV.0212000140	G 3/8" M	gr. 60 oz. 2.1	
e) MV.0212000120	G 3/8" F	gr. 70 oz. 2.5	

Screw coupling G 1/2" M

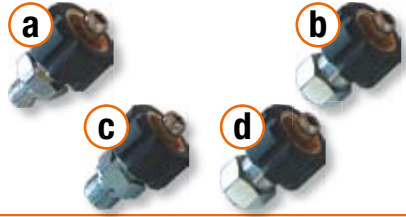

Code	Inlet	Weight	Description
a) MV.0212000050	G 1/4" M	gr. 110 oz. 3.9	Screw quick couplings G 1/2" M. Made of chromed brass. Pressure 250 bar-3600 psi, flow rate 40 l/min-10.50 USGpm, temperature 150 °C-300 °F.
b) MV.0212000030	G 1/4" F	gr. 120 oz. 4.2	
c) MV.0212000040	G 3/8" M	gr. 120 oz. 4.2	
d) MV.0212000020	G 3/8" F	gr. 110 oz. 3.9	



Quick coupling - Screw M 22x1,5 M LONG

The spare parts branded "CdR" exclusively refer to products by Club dei Riparatori® by IDROBASE®

Nipple M 22x1,5 M LONG

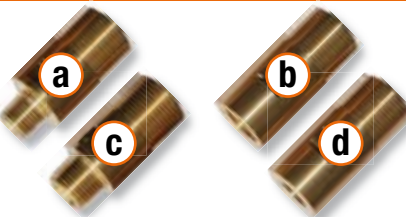

Code	Inlet	Weight	Description
a) CDR.7379	G 1/4" M	gr. 130 oz. 4.6	Nipple M 22x1,5 M long. Made of brass. Pressure 250 bar-3600 psi, flow rate 40 l/min-10.50 USGpm, <i>Ideal for connecting CdR® guns to lances fitting Kärcher</i>
b) CDR.7399	G 1/4" F	gr. 110 oz. 3.9	
c) CDR.7372	G 3/8" M	gr. 130 oz. 4.6	
d) CDR.7392	G 3/8" F	gr. 100 oz. 3.5	



Quick coupling - Screw M 24 - 350 bar

The spare parts branded "CdR" exclusively refer to products by Club dei Riparatori® by IDROBASE®

Nipple M 24 M 350 bar-5100 psi

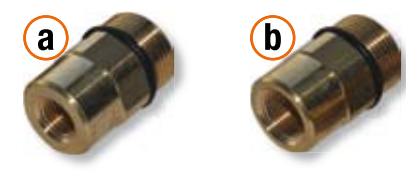





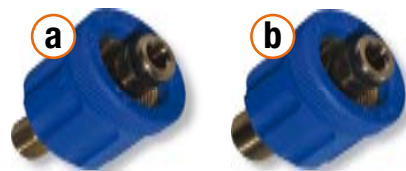



Code	Inlet	Weight	Description
a) CDR.0381	G 1/4" F	gr. 95 oz. 3.4	Nipple M 24 M. Made of brass, with 2 O-Rings inside. Pressure 350 bar-5100 psi, flow rate 30 l/min-8.00 USGpm, temperature 160 °C-320 °F.
e) CDR.0382	G 3/8" F	gr. 95 oz. 3.4	

Screw coupling M 24 F 350 bar-5100 psi



Code	Inlet	Weight	Description
a) CDR.0379	G 1/4" M	gr. 125 oz. 4.4	Screw quick coupling M 24 F. Made of brass. Pressure 350 bar-5100 psi, flow rate 30 l/min-8.00 USGpm, temperature 160 °C-320 °F.
d) CDR.0380	G 3/8" M	gr. 130 oz. 4.6	

Quick coupling - Swivel

<p>CDR.7159 Swivel coupling "Light", made of brass, G 3/8" M-F, 220 bar-3200 psi, 30 l/min-8.00 USGpm, 90°C-195 °F</p> 	<p>CDR.0017 Swivel coupling, made of brass, G 1/4" M-F, 250 bar-3600 psi, 40 l/min-10.50 USGpm, 160°C-320 °F</p> 	<p>CDR.0367 Swivel coupling, made of brass, G 3/8" M-F, 250 bar-3600 psi, 40 l/min-10.50 USGpm, 160°C-320 °F</p> 	<p>MV.0212006500 Swivel quick coupling, inlet G 1/4" M, outlet M 22x1,5 F</p> 				
gr. 100 oz. 3.6	Suitable to connect gun with h.p. hose	gr. 175 oz. 6.2	Suitable to connect gun with h.p. hose	gr. 175 oz. 6.2	Suitable to connect gun with h.p. hose	gr. 160 oz. 5.7	
<p>ZX.1046 Swivel quick coupling, inlet M 22x1,5 M, outlet M 22x1,5 F</p> 	<p>P.26.0055.00 Quick coupling, M 22x1,5 M-M</p> 	<p>CDR.0001 H.p. ball quick coupling, female fitting Kew, inlet G 1/4" M, 250 bar 3600 psi, 150°C 300 °F</p> 	<p>AB.0004 H.p. ball quick coupling, male fitting Kew, inlet G 1/4" F, 250 bar-3600 psi, 150°C-300 °F</p> 				
gr. 200 oz. 7.1		gr. 170 oz. 6.0		gr. 240 oz. 8.5		gr. 70 oz. 2.5	



Quick coupling - Water inlet

The spare parts branded "CdR" exclusively refer to products by Club dei Riparatori® by IDROBASE®

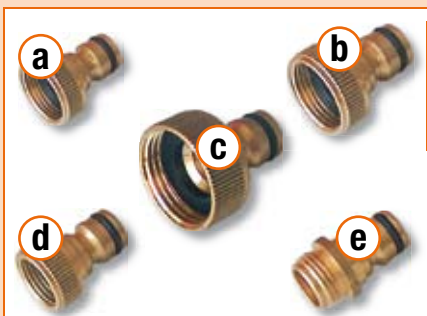

Code	Inlet	Weight	Description
a) CDR.7006	G 1/2" F	gr. 45 oz. 1.6	L.p. ball quick coupling, male, made of brass, 10 bar, <i>Complete with seal. Particularly recommended for water inlet</i>
b) CDR.7007	G 3/4" F	gr. 50 oz. 1.8	
c) CDR.7008	G 1" F	gr. 70 oz. 2.5	
d) CDR.7136	M 22x1,5" F	gr. 50 oz. 1.8	
e) CDR.7171	G 1/2" M	gr. 40 oz. 1.5	

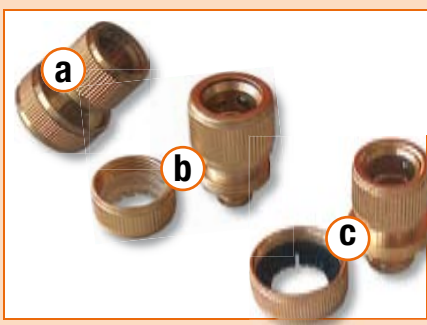

Code	Inlet	Weight	Description
a) CDR.7169	G 3/4" F	gr. 125 oz. 4.5	L.p. ball quick coupling, female, made of brass, 10 bar, <i>Particularly recommended for water inlet</i>
b) CDR.7200	ø 12/15	gr. 110 oz. 3.9	
c) CDR.7201	ø 16/19	gr. 130 oz. 4.6	



Code	Inlet	Weight	Description
a) CDR.7177	G 1/2" F	gr. 75 oz. 2.7	a) L.p. quick coupling, female, made of brass. b) L.p. quick coupling, tail, made of brass. c) Water seal for a) and b) quick coupling <i>Particularly recommended for water inlet</i>
a) CDR.7178	G 3/4" F	gr. 80 oz. 2.9	
b) CDR.7182	ø12 mm-0.47"	gr. 80 oz. 2.9	
b) CDR.7179	ø16 mm-0.63"	gr. 85 oz. 3.0	
b) CDR.7180	ø20 mm-0.79"	gr. 85 oz. 3.4	
c) CDR.7181		gr. 5 oz. 0.2	

Food industry accessories

CDR.0300

Spray gun, compensated blue,
inlet G 3/8" F, outlet G 1/4" F,
350 bar
5100 psi,
30 l/min
8.00 USGpm,
160 °C
320 °F



gr. 660
oz. 23.3

CDR.0070

L.p. spray gun for big flow rate,
made of brass, inlet G 1/2" F,
24 bar
350 psi,
100 l/min
26.40 USGpm,
90 °C
195 °F



gr. 950
oz. 33.6

CDR.0065

Swivel coupling, for l.p. spray gun, made of
brass, G 1/2" M-F,
24 bar
350 psi,
100 l/min
26.40 USGpm,
90 °C
195 °F



gr. 125
oz. 4.5



Code	Length	Weight	Description
ZX.7124	700 mm 28"	gr. 490 oz. 17.3	CdR® 80 moulded blue handle lance, with bend. Made of stainless steel pipe, with nozzle holder coupling and protection.
ZX.7125	900 mm 36"	gr. 580 oz. 20.5	280 bar-4050 psi, 40 l/min-10.50 USGpm,
ZX.7126	1200 mm 47"	gr. 870 oz. 30.8	150 °C-300 °F.

H.p. hose R1 5/16"
315 bar-4550 psi, BLUE

Code

Length
m ft

Weight



G 3/8" F

G 3/8" F

ZB.CC080D2H2H	8 26.25	gr. 2540 oz. 88.9
ZB.CC100D2H2H	10 32.80	gr. 3090 oz. 108.2
ZB.CC150D2H2H	15 49.20	gr. 4460 oz. 156.1
ZB.CC200D2H2H	20 65.60	gr. 5840 oz. 204.4

With handles and stainless steel AISI 316 connections

H.p. hose R2 5/16"
400 bar-5800 psi, BLUE

Code

Length
m ft

Weight



G 3/8" F

G 3/8" F

ZB.DC080D2H2H	8 26.25	gr. 3990 oz. 139.7
ZB.DC100D2H2H	10 32.80	gr. 4900 oz. 171.5
ZB.DC150D2H2H	15 49.20	gr. 7170 oz. 251.0
ZB.DC200D2H2H	20 65.60	gr. 9450 oz. 330.8

With handles and stainless steel AISI 316 connections

Ball valves

TG.FT221138

H.p. ball valve, 2 way,
made of zinc plated steel,
G 3/8" F-F,
500 bar
7250 psi



gr. 650
oz. 23.0

TG.FT221112

H.p. ball valve, 2 way,
made of zinc plated steel,
G 1/2" F-F,
500 bar
7250 psi



gr. 750
oz. 26.5

EFF.2621X204

H.p. ball valve, 2 way,
made of stainless steel
AISI 316,
G 1/2" F-F,
100 bar
1450 psi,
80 l/min
21.00 USGpm



gr. 650
oz. 23.0

EFF.26550203

H.p. ball valve, 2 way,
made of stainless steel
AISI 316,
G 3/8" F-F,
210 bar
3050 psi,
80 l/min
21.00 USGpm



gr. 950
oz. 33.6

EFF.26550204

H.p. ball valve, 2 way,
made of stainless steel
AISI 316,
G 1/2" F-F,
210 bar
3050 psi,
80 l/min
21.00 USGpm



gr. 950
oz. 33.6

H.p. ball valves



Code	Inlet	Outlet	Weight	Description
EFF.2321N203	G 3/8" F	G 3/8" F	gr. 500 oz. 17.5	H.p. ball valves, made of brass, acetal resin h.p. seals and O-Ring in Viton. 210 bar-3050 psi.
EFF.2321N204	G 1/2" F	G 1/2" F	gr. 650 oz. 22.8	
EFF.2321N205	G 3/4" F	G 3/4" F	gr. 1200 oz. 42.0	
EFF.2321N206	G 1" F	G 1" F	gr. 1550 oz. 54.3	

H.p. hose reel

RA.AV1100FE

Automatic hose reel, made of painted steel,
inlet G 1/2" M,
outlet G 3/8" M,
200 bar
2900 psi



gr. 20000
oz. 706.0

Automatic hose reel
for hose ϕ 1/2", 20 m-65.60 ft

RA.AV1100

Automatic hose reel, made of stainless steel,
inlet G 1/2" M,
outlet G 3/8" M,
200 bar
2900 psi



Automatic hose reel
for hose ϕ 1/2", 20 m-65.60 ft

gr. 18000
oz. 636.0

ZX.1111

Manual hose reel, made of nylon,
inlet G 3/8" M,
outlet M 22x1,5 M,
200 bar
2900 psi,
150 °C
300 °F

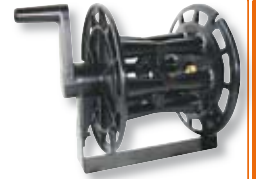

gr. 1300
oz. 45.9

Manual hose reel
for hose ϕ 5/16", 18 m-59.00

RA.ST20FE

Swivel bracket, made of painted steel,
for automatic hose reel
(code RA.AV1100FE)



gr. 1000
oz. 35.0

RA.ST20

Swivel bracket, made of stainless steel,
for automatic hose reel
(code RA.AV1100)



gr. 1000
oz. 35.0

RA.KIT-11

Seal kit,
for automatic hose reel
(codes RA.AV1100FE-RA.AV1100)



gr. 10
oz. 0.4

RA.KIT-92

Spring kit,
for automatic
hose reel
(codes
RA.AV1100FE,
RA.AV1100)



gr. 7850
oz. 277.2

RA.4961

Swivel coupling,
for automatic
painted steel hose reel,
(code RA.AV1100FE)



gr. 240
oz. 8.5

RA.4963

Swivel coupling,
for automatic
stainless steel hose reel,
(code RA.AV1100)



gr. 240
oz. 8.5

Carwash - Swivel couplings

High pressure swivel couplings suitable for high performance in boom carwash systems and also in hose reel. All our swivel couplings are made of brass body with multi-layers coating for anti-corrosion and internal part in SS AISI 316.

Straight swivel couplings



Code	Inlet	Outlet	Weight	Description
CDR.1081	G 1/4" M	G 1/4" F	gr. 330 oz. 11.6	Straight swivel coupling, made of nicked brass, with stainless steel ball bearings lubricated with water resistant grease for low friction. 200 bar-2900 psi, 90°C-195 °F
CDR.1082	G 3/8" M	G 3/8" F	gr. 330 oz. 11.6	
CDR.1083	G 3/8" M	G 1/4" F	gr. 330 oz. 11.6	

90° swivel couplings



Code	Inlet	Outlet	Weight	Description
CDR.1077	G 1/4" M	G 1/4" F	gr. 330 oz. 11.6	90° swivel coupling, made of nicked brass, with stainless steel ball bearings lubricated with water resistant grease for low friction. 150 bar-2000 psi, 90°C-195 °F
CDR.1078	G 3/8" M	G 3/8" F	gr. 330 oz. 11.6	

L.p. nipples



Code	Size	Weight	Description
CDR.7183	G 1/4" M G 1/8" M	gr. 15 oz. 0.6	Brass l.p. nipples. Ideal for connecting filters, restrictor valves and unloader valves to pump suction.
CDR.7184	G 1/4" M G 1/4" M	gr. 21 oz. 0.8	
CDR.7185	G 3/8" M G 1/4" M	gr. 30 oz. 1.1	
CDR.7186	G 3/8" M G 3/8" M	gr. 35 oz. 1.3	
CDR.7187	G 1/2" M G 3/8" M	gr. 46 oz. 1.7	
CDR.7188	G 1/2" M G 1/2" M	gr. 35 oz. 1.3	
CDR.7189	G 3/4" M G 1/2" M	gr. 62 oz. 2.2	
CDR.7190	G 3/4" M G 3/4" M	gr. 85 oz. 3.0	
CDR.7191	G 1" M G 3/4" M	gr. 118 oz. 4.2	

L.p. reducers



Code	Size	Weight	Description
CDR.7192	G 1/4" M G 1/8" F	gr. 7 oz. 0.3	Brass l.p. reducers. Ideal for connecting filters, restrictor valves and unloader valves to pump suction.
CDR.7193	G 3/8" M G 1/4" F	gr. 18 oz. 0.7	
CDR.7194	G 1/2" M G 1/8" F	gr. 38 oz. 1.4	
CDR.7195	G 1/2" M G 3/8" F	gr. 27 oz. 1.0	
CDR.7196	G 3/4" M G 1/4" F	gr. 62 oz. 2.2	
CDR.7197	G 3/4" M G 1/2" F	gr. 45 oz. 1.6	

L.p. elbow



Code	Size	Weight	Description
CDR.7198	G 1/4" M G 1/4" F	gr. 58 oz. 2.1	Brass l.p. elbows. Ideal for connecting filters, restrictor valves and unloader valves to pump suction.
CDR.7199	G 3/8" M G 3/8" F	gr. 85 oz. 3.0	
CDR.7202	G 1/2" M G 1/2" F	gr. 98 oz. 3.5	
CDR.7203	G 3/4" M G 3/4" F	gr. 160 oz. 5.7	
CDR.7204	G 1" M G 1" F	gr. 185 oz. 6.6	

L.p. tee



Code	Size	Weight	Description
CDR.7205	G 1/4" F-F-F	gr. 70 oz. 2.5	Brass l.p. tee. Ideal for connecting filters, restrictor valves and unloader valves to pump suction.
CDR.7206	G 3/8" F-F-F	gr. 90 oz. 3.2	
CDR.7207	G 1/2" F-F-F	gr. 110 oz. 3.9	
CDR.7208	G 3/4" F-F-F	gr. 165 oz. 5.9	
CDR.7209	G 1" F-F-F	gr. 195 oz. 6.9	

H.p. nipples
(zinc plated steel)



Code	Size	Weight	Description
VN.N118	G 1/8" M G 1/8" M	gr. 40 oz. 1.5	H.p. conical nipples. Made of zinc plated steel, tapered 60°. 250 bar-3600 psi, 40 l/min-10.50 USGpm, 150 °C-300 °F
VN.N114	G 1/4" M G 1/4" M	gr. 40 oz. 1.5	
VN.N138	G 3/8" M G 3/8" M	gr. 40 oz. 1.5	
VN.N112	G 1/2" M G 1/2" M	gr. 70 oz. 2.5	
VN.N134	G 3/4" M G 3/4" M	gr. 100 oz. 3.6	
VN.N21418	G 1/8" M G 1/4" M	gr. 30 oz. 1.1	
VN.N23814	G 1/4" M G 3/8" M	gr. 40 oz. 1.5	
VN.N21214	G 1/4" M G 1/2" M	gr. 70 oz. 2.5	
VN.N21238	G 3/8" M G 1/2" M	gr. 70 oz. 2.5	
VN.N23412	G 1/2" M G 3/4" M	gr. 90 oz. 3.2	

H.p. nipples
(stainless steel AISI 316)



Code	Size	Weight	Description
CDR.0777	G 1/8" M G 1/8" M	gr. 15 oz. 0.6	H.p. conical nipples. Made of stainless steel AISI 316, tapered 60° female. 250 bar-3600 psi, 40 l/min-10.50 USGpm, 150 °C-300 °F
CDR.0778	G 1/4" M G 1/4" M	gr. 30 oz. 1.1	
CDR.0779	G 3/8" M G 3/8" M	gr. 45 oz. 1.6	
CDR.0780	G 1/2" M G 1/2" M	gr. 70 oz. 2.5	
CDR.0781	G 3/4" M G 3/4" M	gr. 115 oz. 4.1	
CDR.0782	G 1/8" M G 1/4" M	gr. 25 oz. 0.9	
CDR.0783	G 1/4" M G 3/8" M	gr. 40 oz. 1.5	
CDR.0784	G 1/4" M G 1/2" M	gr. 65 oz. 2.3	
CDR.0785	G 3/8" M G 1/2" M	gr. 85 oz. 3.0	
CDR.0786	G 1/2" M G 3/4" M	gr. 105 oz. 3.8	

H.p. reducers



Code	Size	Weight	Description
VN.T23R1418	G 1/4" M G 1/8" M	gr. 40 oz. 1.5	H.p. conical reducers. Made of tropicalized steel 11SMnPb37, tapered 60° female. 250 bar-3600 psi, 40 l/min-10.50 USGpm, 150 °C-300 °F
VN.T23R3818	G 3/8" M G 1/8" M	gr. 40 oz. 1.5	
VN.T23R3814	G 3/8" M G 1/4" M	gr. 40 oz. 1.5	
VN.T23R1214	G 1/2" M G 1/4" M	gr. 50 oz. 1.8	
VN.T23R1238	G 1/2" M G 3/8" M	gr. 50 oz. 1.8	
VN.T23R3414	G 3/4" M G 1/4" M	gr. 90 oz. 3.2	
VN.T23R3438	G 3/4" M G 3/8" M	gr. 80 oz. 2.9	
VN.T23R3412	G 3/4" M G 1/2" M	gr. 70 oz. 2.5	



Connections - High pressure

The spare parts branded "CdR®" exclusively refer to products by Club dei Riparatori® by IDROBASE®

H.p. elbow

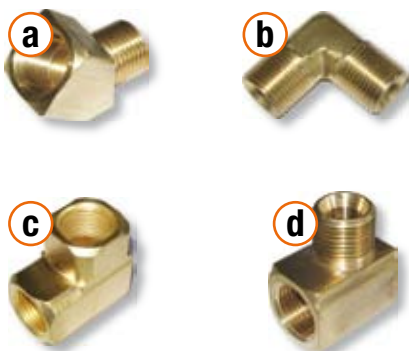

Code	Size	Ang.	Weight	Description
a) CDR.7030	G 1/4" M G 1/8" M	45°	gr. 50 oz. 1.8	H.p. elbow connections. made of brass. Suitable for bearing used in hot and cold h.p. washers. 210 bar-3050 psi, 40 l/min-10.50 USGpm, 150 °C-300 °F
a) CDR.7031	G 3/8" M G 1/8" M	45°	gr. 50 oz. 1.8	
b) CDR.7271	G 3/8" M G 1/4" M	90°	gr. 70 oz. 2.5	
c) CDR.7270	G 1/2" M G 1/4" M	90°	gr. 70 oz. 2.5	
d) CDR.7032	G 3/4" M G 3/8" M	90°	gr. 85 oz. 3.0	
d) CDR.7033	G 3/4" M G 1/2" M	90°	gr. 70 oz. 2.5	

H.p. tee

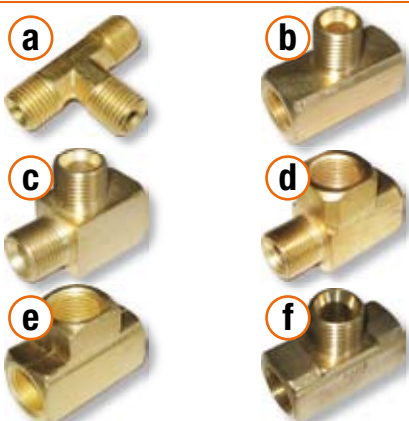

Code	Size	Weight	Description
a) CDR.7273	G 1/4" M-M-M	gr. 90 oz. 3.2	H.p. tee connections. made of brass. Suitable for bearing used in hot and cold h.p. washers. 210 bar-3050 psi, 40 l/min-10.50 USGpm, 150 °C-300 °F
b) CDR.7275	G 1/4" F-M-F	gr. 100 oz. 3.6	
c) CDR.7277	G 3/8" M-M-F	gr. 105 oz. 3.8	
d) CDR.7274	G 3/8" M-F-F	gr. 135 oz. 4.8	
e) CDR.7272	G 3/8" F-F-F	gr. 145 oz. 5.2	
f) CDR.7028	G 3/8" F-M-F	gr. 100 oz. 3.6	
f) CDR.7029	G 1/2" M-M-F	gr. 100 oz. 3.6	



Connections - Various high pressure

H.p. swivel nipples

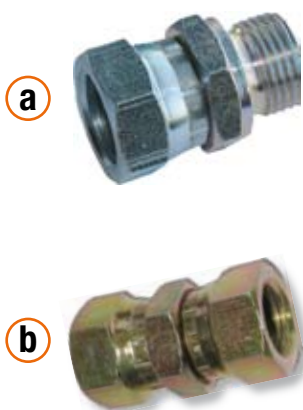

Code	Size	Weight	Description
a) VN.N6NGMF14	G 1/4" M G 1/4" F	gr. 50 oz. 1.8	H.p. swivel nipples. Made of tropicalized steel 11SMnPb37 and zinc plated steel, tapered 60° female. 250 bar-3600 psi, 40 l/min-10.50 USGpm, 150 °C-300 °F
a) VN.N6NGMF38	G 3/8" M G 3/8" F	gr. 60 oz. 5.2	
a) VN.N6NGMF12	G 1/2" M G 1/2" F	gr. 110 oz. 3.9	
a) VN.N6NGMF34	G 3/4" M G 3/4" F	gr. 145 oz. 5.1	
b) VN.N6NGFF14	G 1/4" F G 1/4" F	gr. 70 oz. 2.5	
b) VN.N6NGFF38	G 3/8" F G 3/8" F	gr. 90 oz. 3.2	
b) VN.N6NGFF12	G 1/2" F G 1/2" F	gr. 140 oz. 5.0	
b) VN.N6NGFF34	G 3/4" F G 3/4" F	gr. 180 oz. 6.4	

H.p. swivel elbows

Code	Size	Weight	Description
VN.C35MF14	G 1/4" M G 1/4" F	gr. 60 oz. 2.2	H.p. swivel nipples. Made of zinc plated steel, tapered 60°. 250 bar-3600 psi, 40 l/min-10.50 USGpm, 150 °C-300 °F
VN.C35MF38	G 3/8" M G 3/8" F	gr. 100 oz. 3.6	
VN.C35MF12	G 1/2" M G 1/2" F	gr. 170 oz. 6.0	

H.p. short extensions

Code	Length	Size	Weight	Description
a) VN.P24C14	31 mm 1.22"	G 1/4" M G 1/4" F	gr. 40 oz. 1.5	H.p. short extension Made of tropicalized steel 11SMnPb37, tapered 60°. 250 bar-3600 psi, 40 l/min-10.50 USGpm, 150 °C-300 °F
a) CDR.0946	33 mm 1.30	G 1/4" M G 3/8" f	gr. 50 oz. 1.8	
a) CDR.0947	36 mm 1.42"	G 1/4" M G 1/2" F	gr. 85 oz. 3.0	
a) VN.P24C38	35 mm 1.38"	G 3/8" M G 3/8" F	gr. 60 oz. 2.2	
a) CDR.0948	38 mm 1.50"	G 3/8" M G 1/2" M	gr. 70 oz. 2.5	
b) VN.P26F14	25 mm 0.98"	G 1/4" F G 1/4" F	gr. 40 oz. 1.5	
b) VN.P26F38	30 mm 1.18"	G 3/8" F G 3/8" F	gr. 50 oz. 1.8	
b) VN.P26F12	35 mm 1.38"	G 1/2" F G 1/2" F	gr. 80 oz. 2.9	

H.p. long extensions

Code	Length	Size	Weight	Description
VN.P2614	46 mm 1.81"	G 1/4" M G 1/4" F	gr. 60 oz. 2.2	H.p. long extension Made of tropicalized steel 11SMnPb37, tapered 60°. 250 bar-3600 psi, 40 l/min-10.50 USGpm, 150 °C-300 °F
VN.P2638	46 mm 1.81"	G 3/8" M G 3/8" F	gr. 90 oz. 3.2	
CDR.0949	44 mm 1.73"	G 3/8" M G 3/4" F	gr. 60 oz. 2.2	
CDR.0950	46 mm 1.81"	G 1/2" M G 3/4" F	gr. 90 oz. 3.2	

H.p. caps

Code	Size	Weight	Description
VN.T1418	G 1/8" M	gr. 10 oz. 0.4	H.p. caps Made of tropicalized steel 11SMnPb37, tapered 60°. 250 bar-3600 psi, 40 l/min-10.50 USGpm, 150 °C-300 °F
VN.T1414	G 1/4" M	gr. 25 oz. 0.9	
VN.T1438	G 3/8" M	gr. 40 oz. 1.5	
VN.T1412	G 1/2" M	gr. 60 oz. 2.2	
VN.T1434	G 3/4" M	gr. 100 oz. 3.6	

500 bar-7250 psi - Components and accessories

ELE.ROCCIA

Control panel for COLD WATER pressure washer, equipped with: ON-OFF general switch, Star-Delta starting device, LED for indicating lack of electricity and lack of water.

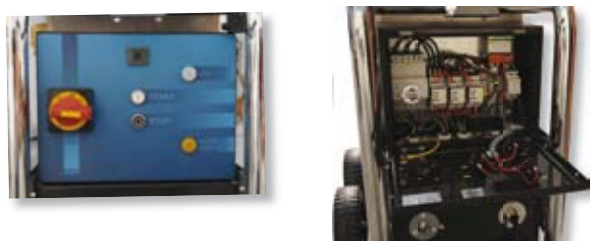

gr. 20000

oz. 700.0

CDR.0312

Electric Motor 20 HP, 15 Kw, 1450 / 1750 Rpm 380-415 V-50Hz, 380-480 V-60Hz, insulation class S1, protection IP55.



gr. 95000

oz. 3325.0

Solid shaft $\varnothing 38$ mm - 1.50"

CDR.0320

Pump-motor coupling, made of cast iron, motor side $\varnothing 38$ mm - 1.50", pump side $\varnothing 24$ mm - 0.94"



gr. 2500

oz. 87.5

GRP.0005

Water tank, made of stainless steel AISI 304, dimensions (LxPxH): 41x20x43 cm 1.61"x0.79"x1.69" Complete with divider and holes for: float valve, water inlet, water outlet and level sensor.



gr. 12000

oz. 420.0

Cover not included

CDR.0423

Safety valve VS 500, 500 bar-7250 psi, 80 l/min-21.10 USGpm, 90 °C-195 °F



The valves supplied are **NOT PRESSURE ADJUSTED.** They became a safety device when adjusted by the installer on the machine

gr. 1450

oz. 51.2

Inlet G 1/2" F
By-pass G 3/8" F

CDR.0422

Unloader valve VB 16, 500 bar-7250 psi, 80 l/min-21.10 USGpm, 90 °C-195 °F, inlet G 1/2" F, outlet G 1/2" F



110 bar is the pressure at the by-pass restart. 190 bar is the residual pressure, when the circuit closes.

gr. 3450

oz. 121.8

H.p. hose R2 3/8", BLACK
500 bar-7250 psi

Code

Length
m ft

Weight



ZN.FC100B2D2D

10 32.80 gr. 5200
oz. 182.0

G 3/8" F

G 3/8" F



ZN.FC150B2D2D

15 49.20 gr. 7620
oz. 266.7



ZN.FC200B2D2D

20 65.60 gr. 10050
oz. 351.8

With handles

CDR.0441

Pressure gauge, made of stainless steel AISI 304, bottom entry 1/4" M, $\varnothing 63$ mm-2.5", 0-1000 bar-0-14500 psi,



gr. 130

oz. 4.6

CDR.0426

Stainless steel nipple, inlet G 1/2" M, outlet M 24x1,5 M, 500 bar-7250 psi, 80 l/min-21.10 USGpm, 160 °C-320 °F



gr. 75

oz. 2.7

CDR.0427

Screw quick coupling, made of stainless steel, inlet G 3/8" M, outlet M 24x1,5 M, 500 bar-7250 psi, 80 l/min-21.10 USGpm, 160 °C-320 °F



gr. 145

oz. 5.2

CDR.0428

Screw quick coupling, made of stainless steel, inlet G 3/8" F, outlet M 24x1,5 M, 500 bar-7250 psi, 80 l/min-21.10 USGpm, 160 °C-320 °F



gr. 145

oz. 5.2

500 bar-7250 psi - Components and accessories

<p>CDR.0402 Shoulder board for spray gun RL 84, 300 mm-11.8", inlet M 18x1,5 M</p>  <p>gr. 310 oz. 11.0</p>	<p>CDR.0311 Spray gun RL 84, inlet G 1/2" F, outlet G 1/2" F, 500 bar 7250 psi, 80 l/min 21.10 USGpm, 100 °C 210 °F</p>  <p>gr. 1700 oz. 60.0</p>	<p>CDR.0392 Stainless steel lance, 800 mm-31.5", inlet G 1/2" M, outlet 1/4" NPT-F, 500 bar 7250 psi</p>  <p>gr. 1500 oz. 53.0</p>	<p>CDR.0393 Stainless steel lance, 1250 mm-49.2", inlet G 1/2" M, outlet 1/4" NPT-F, 500 bar 7250 psi</p>  <p>gr. 2150 oz. 76.0</p>
--	--	--	--

1/4" NPT-M



Code	Nozzle	Description
CDR.500-15035	035	H.p. nozzles 500 bar-7250 psi 1/4" NPT-M, made of stainless steel AISI 420, angle 15°.
CDR.500-1504	04	
CDR.500-1505	05	
CDR.500.15055	055	

500 bar-7250 psi



Code	Nozzle	Description
CDR.0565	03	Professional rotating nozzles. Inlet G 1/4" F, max pressure 500 bar-7250 psi, max temperature 90 °C-195 °F.
CDR.0566	035	
CDR.0409	04	
CDR.0410	045	
CDR.0411	05	
CDR.0412	055	
CDR.0413	06	
CDR.0414	065	
CDR.0415	07	

Sand blast head

(without nozzle)



Code	Description	Weight
CDR.0416	Sand blasting "flat" nozzle, inlet G 1/4" F, 500 bar-7250 psi, 80 l/min-21.10 USGpm,. It is compulsory to use in sand blast nozzle, an h.p. stainless steel nozzle AISI 304, 15°, 500 bar-7250 psi (for h.p. nozzle see page 210)	gr. 890 oz. 31.2

Adjustable probe



Code	Description	Weight
CDR.0417	Adjustable stainless steel probe, for sand blasting kit, 500 mm-19.7" length, inlet ø21 mm-0.83".	gr. 670 oz. 23.5

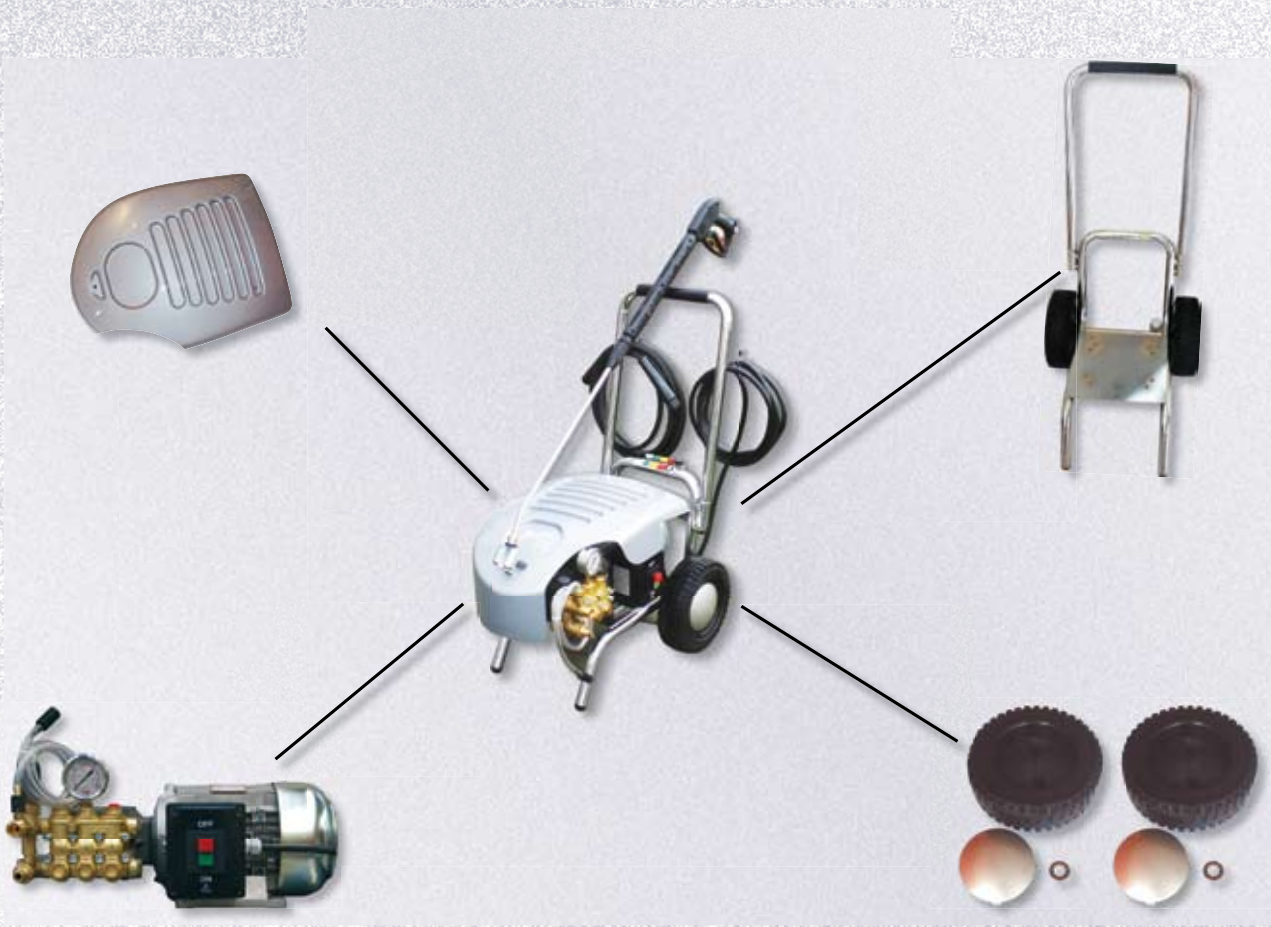

Costruisci la tua idropulitrice professionale
Manufacture your professional h.p. washer



Easy Puzzle® - Frame set

Easy Puzzle® is a complete business plan
to manufacture a whole range of h.p. washers

ZX.0360

Frame set made of chromed steel,
complete with: removable
insulated handle,
n. 2 rubber wheels
ø250x20 mm-9.9"x0.8",
with cover, stop discs
and cover
fixing supports



gr. 7000
oz. 247.1

Frame set to manufacture
cold h.p. washer

ZX.0234

Cover in thermodynamic polystyrene
complete with fixing screws



gr. 900
oz. 31.8

Cover set to manufacture
cold h.p. washer

ZX.0361

Frame set made of chromed steel,
complete with: removable
insulated handle,
n. 2 vulcanised
rubber wheels
ø260x20 mm-10.3"x0.8",
with cover
and stop discs



gr. 11000
oz. 388.3

Frame set to manufacture
cold h.p. washer

BF.0004

Kit cover support
for h.p. washer
(code ZX.0351)



gr. 1300
oz. 45.9

ZX.0239

Cover in thermodynamic polystyrene
complete with fixing screws



gr. 1200
oz. 42.4

Cover set to manufacture
cold h.p. washer

ZX.0350

Base set made of chromed steel,
complete with: removable
insulated handle,
n. 2 rubber wheels
ø250x20 mm-9.9"x0.8",
with cover
and stop discs



gr. 6600
oz. 233.0

Pre-drilled base set to bed:
- 3 and 5,5 HP electric motors
- 6 HP Petrol engine



Easy Puzzle® - Electrical boxes

Easy Puzzle® is a complete business plan
to manufacture a whole range of h.p. washers

ZX.0661

**Electrical box for
single-phase motor,**
cold h.p. washer,
3 HP,
230 V-50 Hz,
14 A



gr. 1300
oz. 45.9

Electrical box complete with:
- single phase switch
- 5 m-16.40 ft electric cable

ZX.0662

**Electrical box for
three-phase motor,**
cold h.p. washer,
5,5 HP, 400 V
50 Hz, 10 A



gr. 1550
oz. 54.8

Electrical box complete with:
- three-phase switch
- 5 m-16.40 ft electric cable

ZX.0663

**Electrical box for
three-phase motor,**
cold h.p. washer,
7,5 HP, 400 V
50 Hz, 14 A



gr. 1550
oz. 54.8

Electrical box complete with:
- three-phase switch
- 5 m-16.40 ft electric cable



Easy Puzzle® - H.p. washers components - Wheels

Easy Puzzle® is a complete business plan
to manufacture a whole range of h.p. washers

ZX.0347

Vulcanised rubber wheel
ø260x20 mm, ø9.2"x0.7", complete with:
wheel cover and stop discs



gr. 2310
oz. 81.6

ZX.0348

Rubber wheel
ø220x25 mm,
ø7.8"x0.9",
complete with:
black wheel cover
and stop discs



gr. 730
oz. 25.8

ZX.0349

Rubber wheel
ø250x20 mm
ø8.8"x0.7",
complete with:
wheel cover
and stop discs



gr. 840
oz. 29.7



Easy Puzzle® - H.p. washers components - Wheels

The spare parts branded "CdR" exclusively refer to products by Club dei Riparatori® by IDROBASE®

Pivot "light"



Code	Wheel ø mm-in	Total height mm-in	Fixing bracket mm-in	Wheel-base mm-in	Capacity kg-lbs	Weight
a) CDR.7342	100 4"	125 5"	102x84 4"x3.5"	80x60 3"x2.5"	70 154.5	gr. 830 oz. 29.5
b) CDR.7344	125 5"	150 6"	102x84 4"x3.5"	80x60 3"x2.5"	100 220.0	gr. 1090 oz. 38.5

Black rubber castor,
for professional use, with fixing bracket

Code	Wheel ø mm-in	Total height mm-in	Fixing bracket mm-in	Wheel-base mm-in	Capacity kg-lbs	Weight
c) CDR.7343	100 4"	125 5"	102x84 4"x3.5"	80x60 3"x2.5"	70 154.5	gr. 960 oz. 34.0
d) CDR.7345	125 5"	150 6"	102x84 4"x3.5"	80x60 3"x2.5"	100 220.0	gr. 1210 oz. 42.7

Black rubber castor with brake device,
for professional use, with fixing bracket

Pivot "heavy"

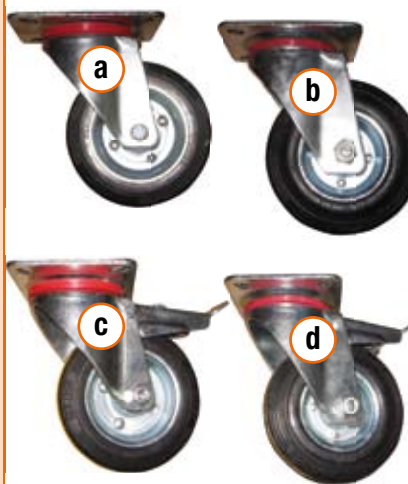

Code	Wheel ø mm-in	Total height mm-in	Fixing bracket mm-in	Wheel-base mm-in	Capacity kg-lbs	Weight
a) CDR.7338	100 4"	125 5"	102x84 4"x3.5"	80x60 3"x2.5"	150 331.0	gr. 830 oz. 29.5
b) CDR.7340	125 5"	150 6"	102x84 4"x3.5"	80x60 3"x2.5"	200 414.0	gr. 1090 oz. 38.5

Black rubber castor,
for professional use, with fixing bracket

Code	Wheel ø mm-in	Total height mm-in	Fixing bracket mm-in	Wheel-base mm-in	Capacity kg-lbs	Weight
c) CDR.7339	100 4"	125 5"	102x84 4"x3.5"	80x60 3"x2.5"	150 331.0	gr. 960 oz. 34.0
d) CDR.7341	125 5"	150 6"	102x84 4"x3.5"	80x60 3"x2.5"	200 414.0	gr. 1210 oz. 42.7

Black rubber castor with brake device,
for professional use, with fixing bracket



Accessories for domestic h.p. washers - H.p. washer / Hose connection

The spare parts branded "CdR" exclusively refer to products by Club dei Riparatori® by IDROBASE®

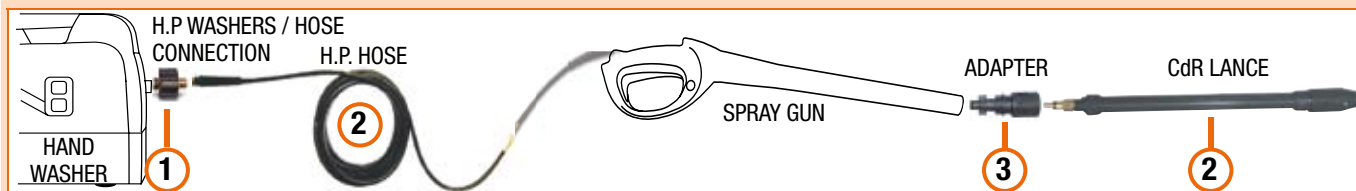

FH.0019
Screw quick coupling,
made of brass
M 22x1,5F ø14-G 1/4" M

gr. 80
oz. 2.9

CDR.7231
Screw quick coupling,
made of brass,
M 22x1,5F ø15-G 1/4" M

gr. 120
oz. 4.3

CDR.7108
Screw quick coupling,
made of brass,
M 22x1,5F ø14-G 1/4"

gr. 120
oz. 4.3

H.p. washers fitting	Dolly connection		
	FH.0019	CDR.7231	CDR.7108
Annovi Reverberi	•		
Faip	•		
Fasa (up to 12 / 1998)	•		
Interpump	•		
Fasa / Lavor		•	
Kärcher	•		
Kew	•		
Lavor		•	
Mec Pump	•		
Sistema		•	
Wap			•

ZX.7020

Set Dolly adapters for hobby accessories



gr. 320
oz. 11.3

Made of plastic
(quantity 1x10 pcs)

3

Combinations of adapters

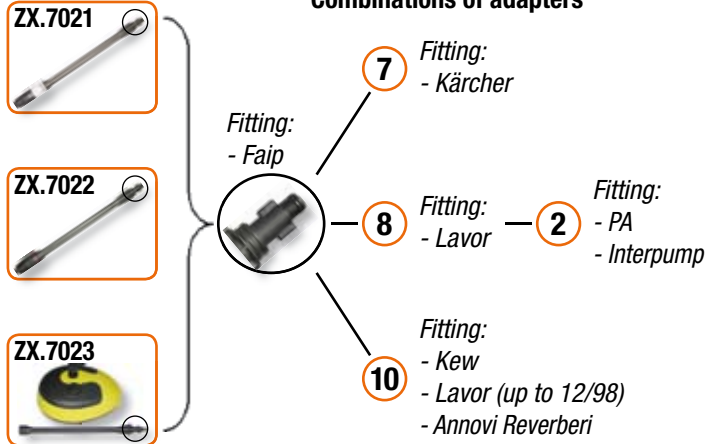

Combinations of adapters

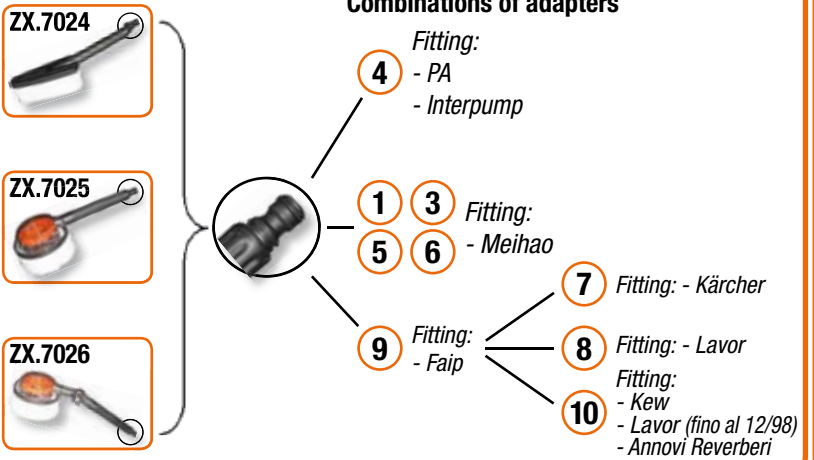

ZX.7021

Extended lance with variable angle nozzle, 450 mm-17.8", 140 bar-2000 psi, 12 l/min-3.15 USGpm, 60 °C-140 °F



gr. 560
oz. 19.8

Complete with set Dolly adapters

ZX.7022

Extended lance with rotating nozzle, 450 mm-17.8", 140 bar-2000 psi, 12 l/min-3.15 USGpm, 60 °C-140 °F



gr. 560
oz. 19.8

Complete with set Dolly adapters

ZX.7023

Surface cleaner with detergent tank, 700 mm-27.6", 140 bar-2000 psi, 12 l/min-3.15 USGpm, 60 °C-140 °F



gr. 2320
oz. 81.9

Complete with set Dolly adapters

ZX.7024

Fixed brush with polypropylene bristles, 320 mm-12.6"



gr. 520
oz. 18.4

Complete with set Dolly adapters

ZX.7025

Rotating brush with polypropylene bristles, 320 mm-12.6"



gr. 750
oz. 26.5

Complete with set Dolly adapters

ZX.7026

Rotating brush articulated with polypropylene bristles, 400 mm-15.8"



gr. 800
oz. 28.3

Complete with set Dolly adapters

<p>CDR.7346 Bayonet adapter, made of brass, complete with O-Ring, inlet G 1/4" F</p>  <p><i>Fitting:</i> • Lavor (starting 01/1999)</p> <p>gr. 45 oz. 1.6</p>	<p>CDR.7380 Bayonet adapter, made of brass, complete with O-Ring, inlet G 1/4" F</p>  <p><i>Fitting:</i> • Lavor (up to 12/1998) • Annovi Reverberi • Kew</p> <p>gr. 45 oz. 1.6</p>	<p>CDR.0372 Bayonet adapter, made of brass, complete with O-Ring, inlet G 1/4" F</p>  <p><i>Fitting:</i> • Kärcher</p> <p>gr. 100 oz. 3.6</p>	<p>CDR.7388 Bayonet adapter, made of plastic, complete with O-Ring, inlet G 1/4" F</p>  <p><i>Fitting:</i> • Kärcher</p> <p>gr. 50 oz. 1.8</p>
<p>CDR.7393 Bayonet adapter, made of brass, complete with O-Ring, inlet G 1/4" F</p>  <p><i>Fitting:</i> • Faip</p> <p>gr. 80 oz. 2.9</p>	<p>CDR.0447 Spray gun with extension, 150 mm-5.9", inlet G 1/4" M, outlet bayonet connection</p>  <p><i>Fitting:</i> • Lavor (starting 1/1999) • Comet • Mec Pump</p> <p>gr. 400 oz. 14.0</p> <p><i>Right adapter , code CDR.0711</i></p>	<p>CDR.0600 Extension with variable angle nozzle, 450 mm-17.8", brass bayonet connection, suitable for spray gun CDR.0447</p>  <p>gr. 120 oz. 4.3</p>	<p>CDR.0111 Extension with rotating nozzle , 450 mm-17.8", brass bayonet connection, suitable for spray gun CDR.0447</p>  <p>gr. 120 oz. 4.3</p>

<p>CDR.7250 Spray gun with extension, 500 mm-19.7", inlet G 1/4" M, outlet M 22x1,5 F 220 bar, 60 °C</p>  <p>gr. 750 oz. 26.5</p>	<p>CDR.7328 Extension lance with variable angle nozzle 0.90, 270 mm-10.7", made of chromed steel, inlet M 22x1,5 M</p>  <p>gr. 185 oz. 6.5</p> <p><i>Right adapter , code CDR.0711</i></p>	<p>CDR.7327 Extension lance with variable angle nozzle 1.05, 270 mm-10.7", made of chromed steel, inlet M 22x1,5 M</p>  <p>gr. 185 oz. 6.5</p>	<p>CDR.7326 Hobby foam kit</p>  <p>gr. 90 oz. 3.2</p>
---	---	--	--



Variable angle nozzle lance



Code	Size	Description
CDR.7320	0,85	Variable angle nozzle lance, 450 mm-17.8" , inlet M 22x 1,5 M. 220 bar-3200 psi, 21 l/min-5.50 USGpm, 60° C-140 °F
CDR.7251	0,90	
CDR.7299	0,95	
CDR.7311	1,05	
CDR.7309	1,15	
		gr. 260 oz. 9.2

Dolly O-Rings
- Fitting Kärcher h.p. washers

The spare parts branded "CdR®" exclusively refer to products by Club dei Riparatori® by IDROBASE®

<p>ZX.0657 Box Dolly O-Rings for accessories fitting Kärcher. In one solution 6 different types of O-Rings and 1 grease</p> <p>In each box there are:</p> <ul style="list-style-type: none"> • no. 1 Set ZX.0658 • no. 2 Set ZX.0154 • no. 1 Set ZX.0659 • no. 1 Set ZX.0660 • no. 1 Grease for O-Rings  <p>gr. 550 oz. 19.5</p>	<p>ZX.0658 Set Dolly O-Rings X38, for gun / hose connection ø10 mm-0.39", fitting Kärcher</p>  <p>gr. 20 oz. 0.8</p> <p>quantity 2x100</p>	<p>IP.0001 O-Rings lubricant - protection</p>  <p>gr. 40 oz. 1.5</p> <p>quantity 1</p>
<p>ZX.0659 Set Dolly O-Rings X39, for gun / hose connection ø11 mm-0.43", fitting Kärcher</p>  <p>gr. 20 oz. 0.8</p> <p>quantity 2x100</p>	<p>ZX.0660 Set Dolly O-Rings X40, for hose with swivel quick coupling M 22x1,5 F, fitting Kärcher</p>  <p>gr. 30 oz. 1.1</p> <p>quantity 2x100</p>	<p>ZX.0154 Set Dolly O-Rings, for nozzle holder and hose quick coupling M 22x1,5, fitting Kärcher</p>  <p>gr. 30 oz. 1.1</p> <p>quantity 1x100</p>

Dolly O-Rings - For pumps
fitting Interpump / Generalpump

The spare parts branded "CdR®" exclusively refer to products by Club dei Riparatori® by IDROBASE®

<p>ZX.0584 Box Dolly O-Rings fitting Interpump and Generalpump. In one solution 8 different types of O-Rings</p> <p>In each box there are:</p> <ul style="list-style-type: none"> • no. 1 Set ZX.0573 • no. 1 Set ZX.0574 • no. 1 Set ZX.0575 • no. 1 Set ZX.0576 • no. 1 Set ZX.0577 • no. 1 Set ZX.0578 • no. 1 Set ZX.0579 • no. 1 Set ZX.0580  <p>gr. 480 oz. 17.0</p>	<p>ZX.0573 Set Dolly 10-50 OR, O-Rings for packing retainers</p> <p>Fitting series: • 47-48</p>  <p>quantity 1x50</p> <p>gr. 18 oz. 0.7</p>	<p>ZX.0574 Set Dolly 86/139-50 OR, O-Rings for packing retainers</p> <p>Fitting series: • 51</p>  <p>quantity 1x50</p> <p>gr. 14 oz. 0.5</p>	<p>ZX.0575 Set Dolly 166/167-50 OR, O-Rings for packing retainers</p> <p>Fitting series: • 63</p>  <p>quantity 1x50</p> <p>gr. 16 oz. 0.6</p>	<p>ZX.0576 Set Dolly 22-50 OR, O-Rings for packing retainers</p> <p>Fitting series: • 44 • 49-50</p>  <p>quantity 1x50</p> <p>gr. 17 oz. 0.6</p>
<p>The O-Rings showed in this pages are a selected range of products guaranteed by</p> <p>Club dei Riparatori</p> <p>Do not be misled by the price !</p> <p>The quality of Club dei Riparatori® O-Rings is the best in the market and their prices are so tempting just because we sell them without agents.</p>	<p>ZX.0577 Set Dolly 12-50 OR, O-Rings for piston bolts</p> <p>Fitting series: • 47-48 • 49-50</p>  <p>quantity 1x50</p> <p>gr. 8 oz. 0.3</p>	<p>ZX.0578 Set Dolly piston guide 50 OR, O-Rings for piston bolts</p> <p>Fitting series: • 44 • 51 • 63</p>  <p>quantity 1x50</p> <p>gr. 5 oz. 0.2</p>	<p>ZX.0579 Set Dolly 1/123-50 OR, O-Rings for valves</p> <p>Fitting series: • 44 • 47-48 • 49-50 • 51 • 63 • Motor-pump</p>  <p>quantity 1x50</p> <p>gr. 22 oz. 0.8</p>	<p>ZX.0580 Set Dolly 4/5-50 OR, O-Rings for caps</p> <p>Fitting series: • 47-48 • 49-50</p>  <p>quantity 1x50</p> <p>gr. 26 oz. 1.0</p>

ZX.0583

Box Dolly O-Rings
for quick couplings.
In one solution
8 different types
of O-Rings



In each box there are:

- no. 1 Set ZX.0581
- no. 1 Set ZX.0569
- no. 1 Set ZX.0582
- no. 1 Set ZX.0570
- no. 1 Set ZX.0567
- no. 1 Set ZX.0571
- no. 1 Set ZX.0568
- no. 1 Set ZX.0572

gr. 655
oz. 23.2

ZX.0581

Set Dolly O-Rings no. 1,
for quick couplings fitting:
Interpump, MTM, Meccanica Veneta



gr. 26
oz. 1.0

quantity
1x100

ZX.0582

Set Dolly O-Rings no. 2,
for screw and swivel quick coupling fitting:
PA, CdR and for M 22 Diesse hoses



gr. 40
oz. 1.5

quantity
1x100

ZX.0567

Set Dolly O-Rings no. 3,
for hoses fitting:
Lavor



gr. 30
oz. 1.1

quantity
1x100

ZX.0568

Set Dolly O-Rings no. 4,
for ball quick coupling fitting:
Meccanica Borroni



gr. 30
oz. 1.1

quantity
1x50

ZX.0569

Set Dolly O-Ring no. 5,
for screw quick coupling fitting:
PA and Meccanica Veneta



gr. 32
oz. 1.2

quantity
1x100

ZX.0572

Set Dolly anti-extrusion rings,
for screw and swivel quick couplings fitting:
PA and CdR



gr. 28
oz. 1.0

quantity
1x100

ZX.0570

Set Dolly O-Rings no. 6,
for ball quick couplings fitting:
Arrow Line, Meccanica Veneta,
MTM, PA and CdR
(made of NBR)



Female part
contains no. 3
O-Rings:
1 pc - O-Ring no. 6
2 pcs - O-Ring no. 7

gr. 44
oz. 1.6

quantity
1x100

ZX.0571

Set Dolly O-Rings no. 7,
for ball quick couplings fitting:
Arrow Line, Meccanica Veneta,
MTM, PA and CdR
(made of NBR)



Female part
contains no. 3
O-Rings:
1 pc - O-Ring no. 6
2 pcs - O-Ring no. 7

gr. 52
oz. 1.9

quantity
1x100

ZX.0922

Set Dolly O-Ring no. 8,
for ball quick couplings fitting:
Arrow Line, Meccanica Veneta,
MTM, PA and CdR
(made of VITON)



Female part
contains no. 3
O-Rings:
1 pc - O-Ring no. 8
2 pcs - O-Ring no. 9

gr. 44
oz. 1.6

quantity
1x100

ZX.0923

Set Dolly O-Ring no. 9,
for ball quick couplings fitting:
Arrow Line, Meccanica Veneta,
MTM, PA and CdR
(made of VITON)



Female part
contains no. 3
O-Rings:
1 pc - O-Ring no. 8
2 pcs - O-Ring no. 9

gr. 52
oz. 1.9

quantity
1x100

Consumer items

- Self-centring blocking washers

ZX.0473

Box Dolly self-centring washers, made of steel with rubber vulcanized on internal diameter. In one solution 6 different size of washers.

In each box there are:

- no. 1 Set ZX.0475
- no. 1 Set ZX.0476
- no. 1 Set ZX.0477
- no. 1 Set ZX.0478
- no. 1 Set ZX.0479
- no. 1 Set ZX.0480

gr. 1450

oz. 51.2



Example:



Seal guaranteed even in delicate connections.

Self-centring washers



Code	Description	ø	Q.ty	Weight	Description
ZX.0475	Set Dolly RA 1/8	1/8"	50 pcs	gr. 80 oz. 2.9	<i>It does not require centring.</i>
ZX.0476	Set Dolly RA 1/4	1/4"	50 pcs	gr. 130 oz. 4.6	<i>High eccentricity makes the seal steadier and reduces the assembly time.</i>
ZX.0477	Set Dolly RA 3/8	3/8"	100 pcs	gr. 290 oz. 10.3	<i>Ideal for connections, nipples, caps, etc.</i>
ZX.0478	Set Dolly RA 1/2	1/2"	50 pcs	gr. 240 oz. 8.5	<i>Temperature max. 90°C</i>
ZX.0479	Set Dolly RA 3/4	3/4"	50 pcs	gr. 330 oz. 11.7	
ZX.0480	Set Dolly RA 1	1"	25 pcs	gr. 220 oz. 7.8	

Consumer items

- Copper washers

ZX.0474

Box Dolly copper washers, In one solution 6 different size of washers.

In each box there are:

- no. 1 Set ZX.0481
- no. 1 Set ZX.0482
- no. 1 Set ZX.0483
- no. 1 Set ZX.0484
- no. 1 Set ZX.0485
- no. 1 Set ZX.0486

gr. 1440

oz. 50.9



Example:



It removes the use of P.T.F.E and sealant

Copper washers







Code	Description	ø	Q.ty	Weight	Description
ZX.0481	Set Dolly RR 1/8	1/8"	100 pcs	gr. 155 oz. 5.5	<i>Throwaway copper washers.</i>
ZX.0482	Set Dolly RR 1/4	1/4"	100 pcs	gr. 190 oz. 6.8	<i>Economic and ideal for connections, nipples, caps, etc.</i>
ZX.0483	Set Dolly RR 3/8	3/8"	200 pcs	gr. 480 oz. 17.0	
ZX.0484	Set Dolly RR 1/2	1/2"	100 pcs	gr. 270 oz. 9.6	
ZX.0485	Set Dolly RR 3/4	3/4"	25 pcs	gr. 110 oz. 3.9	
ZX.0486	Set Dolly RR 1	1"	25 pcs	gr. 130 oz. 4.6	





Consumer items

- Threadlocking and threadsealing

<p>CDR.0848 Threadlocker 54-03, medium strength adhesive.</p> <p>For thread locking of nuts and bolts. Highly resistant to heat, corrosion, vibrations, water, gases, oils, hydrocarbons and many chemicals</p>  <table border="1"> <tr> <td>gr. 80</td> <td>50 ml</td> </tr> <tr> <td>oz. 2.9</td> <td>1.70 fl oz</td> </tr> </table>	gr. 80	50 ml	oz. 2.9	1.70 fl oz	<p>CDR.0849 Threadlocker 54-03, medium strength adhesive.</p> <p>For thread locking of nuts and bolts. Highly resistant to heat, corrosion, vibrations, water, gases, oils, hydrocarbons and many chemicals</p>  <table border="1"> <tr> <td>gr. 360</td> <td>250 ml</td> </tr> <tr> <td>oz. 12.7</td> <td>8.50 fl oz</td> </tr> </table>	gr. 360	250 ml	oz. 12.7	8.50 fl oz	<p>CDR.0850 Threadlocker 55-03, medium strength adhesive.</p> <p>For thread locking of nuts and bolts. Highly resistant to heat, corrosion, vibrations, water, gases, oils, hydrocarbons corrosion and many chemicals</p>  <table border="1"> <tr> <td>gr. 80</td> <td>50 ml</td> </tr> <tr> <td>oz. 2.9</td> <td>1.70 fl oz</td> </tr> </table>	gr. 80	50 ml	oz. 2.9	1.70 fl oz	<p>CDR.0851 Threadlocker 55-03, medium strength adhesive.</p> <p>For thread locking of nuts and bolts. Highly resistant to heat, corrosion, vibrations, water, gases, oils, hydrocarbons corrosion and many chemicals</p>  <table border="1"> <tr> <td>gr. 360</td> <td>250 ml</td> </tr> <tr> <td>oz. 12.7</td> <td>8.50 fl oz</td> </tr> </table>	gr. 360	250 ml	oz. 12.7	8.50 fl oz	<p>CDR.0852 Threadlocker 83-54, high strength adhesive.</p> <p>For locking and sealing of studs, nuts, bolts. Highly resistant to heat, corrosion, vibrations, water, gases, oils, hydrocarbons, and many chemicals</p>  <table border="1"> <tr> <td>gr. 80</td> <td>50 ml</td> </tr> <tr> <td>oz. 2.9</td> <td>1.70 fl oz</td> </tr> </table>	gr. 80	50 ml	oz. 2.9	1.70 fl oz
gr. 80	50 ml																							
oz. 2.9	1.70 fl oz																							
gr. 360	250 ml																							
oz. 12.7	8.50 fl oz																							
gr. 80	50 ml																							
oz. 2.9	1.70 fl oz																							
gr. 360	250 ml																							
oz. 12.7	8.50 fl oz																							
gr. 80	50 ml																							
oz. 2.9	1.70 fl oz																							

<p>CDR.0853 Threadlocker 83-54, high strength adhesive.</p> <p>For locking and sealing of studs, nuts, bolts. Highly resistant to heat, corrosion, vibrations, water, gases, oils, hydrocarbons, and many chemicals</p>  <table border="1"> <tr> <td>gr. 360</td> <td>250 ml</td> </tr> <tr> <td>oz. 12.7</td> <td>8.50 fl oz</td> </tr> </table>	gr. 360	250 ml	oz. 12.7	8.50 fl oz	<p>CDR.0863 Retaining+Sealant 83-21, high strength adhesive.</p> <p>For locking and sealing threads. Highly resistant to heat, corrosion, vibrations, water, gases, oils, hydrocarbons and many chemicals</p>  <table border="1"> <tr> <td>gr. 80</td> <td>50 ml</td> </tr> <tr> <td>oz. 2.9</td> <td>1.70 fl oz</td> </tr> </table>	gr. 80	50 ml	oz. 2.9	1.70 fl oz	<p>CDR.0864 Retaining+Sealant 83-21, high strength adhesive.</p> <p>For locking and sealing threads. Highly resistant to heat, corrosion, vibrations, water, gases, oils, hydrocarbons and many chemicals</p>  <table border="1"> <tr> <td>gr. 360</td> <td>250 ml</td> </tr> <tr> <td>oz. 12.7</td> <td>8.50 fl oz</td> </tr> </table>	gr. 360	250 ml	oz. 12.7	8.50 fl oz	<p>CDR.0854 Threadsealing 53-14, medium strength adhesive.</p> <p>For sealing hydraulic and pneumatics threads connectors up to 3/4". Highly resistant gases, water, LPG, hydrocarbons, oils and other chemicals</p>  <table border="1"> <tr> <td>gr. 80</td> <td>50 ml</td> </tr> <tr> <td>oz. 2.9</td> <td>1.70 fl oz</td> </tr> </table>	gr. 80	50 ml	oz. 2.9	1.70 fl oz	<p>CDR.0855 Threadsealing 53-14, medium strength adhesive.</p> <p>For sealing hydraulic and pneumatics threads connectors up to 3/4". Highly resistant gases, water, LPG, hydrocarbons, oils and other chemicals</p>  <table border="1"> <tr> <td>gr. 360</td> <td>250 ml</td> </tr> <tr> <td>oz. 12.7</td> <td>8.50 fl oz</td> </tr> </table>	gr. 360	250 ml	oz. 12.7	8.50 fl oz
gr. 360	250 ml																							
oz. 12.7	8.50 fl oz																							
gr. 80	50 ml																							
oz. 2.9	1.70 fl oz																							
gr. 360	250 ml																							
oz. 12.7	8.50 fl oz																							
gr. 80	50 ml																							
oz. 2.9	1.70 fl oz																							
gr. 360	250 ml																							
oz. 12.7	8.50 fl oz																							

<p>CDR.0856 Threadsealing 56-03, medium strength adhesive.</p> <p>For sealing hydraulic and pneumatics threads connectors up to 2". Highly resistant to heat, corrosion, shocks and vibrations</p>  <table border="1"> <tr> <td>gr. 360</td> <td>250 ml</td> </tr> <tr> <td>oz. 12.7</td> <td>8.50 fl oz</td> </tr> </table>	gr. 360	250 ml	oz. 12.7	8.50 fl oz	<p>CDR.0857 Threadsealing 85-86, high strength adhesive.</p> <p>For locking and sealing thread connections. Highly resistant to heat, corrosion, vibrations, water, gases, oils, hydrocarbons and many chemicals</p>  <table border="1"> <tr> <td>gr. 80</td> <td>50 ml</td> </tr> <tr> <td>oz. 2.9</td> <td>1.70 fl oz</td> </tr> </table>	gr. 80	50 ml	oz. 2.9	1.70 fl oz	<p>CDR.0858 Threadsealing 85-86, high strength adhesive.</p> <p>For locking and sealing thread connections. Highly resistant to heat, corrosion, vibrations, water, gases, oils, hydrocarbons and many chemicals</p>  <table border="1"> <tr> <td>gr. 360</td> <td>250 ml</td> </tr> <tr> <td>oz. 12.7</td> <td>8.50 fl oz</td> </tr> </table>	gr. 360	250 ml	oz. 12.7	8.50 fl oz	<p>CDR.1279 Threadsealing 18-10, high strength adhesive.</p> <p>Liquid teflon for sealing threaded metal joints. Suitable for sealing joints, used for: gas, LPG, drinking water, compressed air, oil and fuel, etc.</p>  <table border="1"> <tr> <td>gr. 100</td> <td>50 ml</td> </tr> <tr> <td>oz. 3.5</td> <td>1.70 fl oz</td> </tr> </table>	gr. 100	50 ml	oz. 3.5	1.70 fl oz	<p>CDR.1280 Threadsealing 18-10, high strength adhesive.</p> <p>Liquid teflon for sealing threaded metal joints. Suitable for sealing joints, used for: gas, LPG, drinking water, compressed air, oil and fuel, etc.</p>  <table border="1"> <tr> <td>gr. 430</td> <td>250 ml</td> </tr> <tr> <td>oz. 15.1</td> <td>8.50 fl oz</td> </tr> </table>	gr. 430	250 ml	oz. 15.1	8.50 fl oz
gr. 360	250 ml																							
oz. 12.7	8.50 fl oz																							
gr. 80	50 ml																							
oz. 2.9	1.70 fl oz																							
gr. 360	250 ml																							
oz. 12.7	8.50 fl oz																							
gr. 100	50 ml																							
oz. 3.5	1.70 fl oz																							
gr. 430	250 ml																							
oz. 15.1	8.50 fl oz																							

<p>CDR.1291 Polymer 400, lubricating mineral grease.</p> <p>With PTFE, resistant to stress and washing. Lubricates and protects against corrosion and ensures a long life for O-rings and seals</p>  <p>Not compatible with EPDM</p> <table border="1"> <tr> <td>gr. 40</td> <td>30 gr</td> </tr> <tr> <td>oz. 1.4</td> <td>1.05 oz.</td> </tr> </table>	gr. 40	30 gr	oz. 1.4	1.05 oz.	<p>CDR.1292 Polymer 400, lubricating mineral grease.</p> <p>With PTFE, resistant to stress and washing. Lubricates and protects against corrosion and ensures a long life for O-rings and seals</p>  <p>Not compatible with EPDM</p> <table border="1"> <tr> <td>gr. 140</td> <td>100 gr</td> </tr> <tr> <td>oz. 4.9</td> <td>3.50 oz.</td> </tr> </table>	gr. 140	100 gr	oz. 4.9	3.50 oz.	<p>CDR.1293 Silicon Comp 101/S, lubricating silicone grease</p> <p>With PTFE, for a better lubrication and sealing. Compatible with plastic, lubricates and protects against corrosion.</p>  <table border="1"> <tr> <td>gr. 40</td> <td>30 gr</td> </tr> <tr> <td>oz. 1.4</td> <td>1.05 oz.</td> </tr> </table>	gr. 40	30 gr	oz. 1.4	1.05 oz.	<p>CDR.1294 Silicon Comp 101/S, lubricating silicone grease</p> <p>With PTFE, for a better lubrication and sealing. Compatible with plastic, lubricates and protects against corrosion.</p>  <table border="1"> <tr> <td>gr. 140</td> <td>100 gr</td> </tr> <tr> <td>oz. 4.9</td> <td>3.50 oz.</td> </tr> </table>	gr. 140	100 gr	oz. 4.9	3.50 oz.	<p>GU.B20044 CdR 40 P.T.F.E., 12 m-39.40 ft length 12 mm-0.47" width</p>  <table border="1"> <tr> <td>gr. 20</td> <td></td> </tr> <tr> <td>oz. 0.7</td> <td></td> </tr> </table>	gr. 20		oz. 0.7	
gr. 40	30 gr																							
oz. 1.4	1.05 oz.																							
gr. 140	100 gr																							
oz. 4.9	3.50 oz.																							
gr. 40	30 gr																							
oz. 1.4	1.05 oz.																							
gr. 140	100 gr																							
oz. 4.9	3.50 oz.																							
gr. 20																								
oz. 0.7																								

FB.0909
Antiscale solution, 10 Kg-22.07 lbs



gr. 10150
oz. 358.3

FB.0931
Descale solution, 10 Kg-22.07 lbs



gr. 10150
oz. 358.3

Cable-ties



Code	Size	Q.ty	Weight
ZX.0212	135x2,5 mm 5.32"x0.10"	100 pcs	gr. 40 oz. 1.5
ZX.0213	200x3,5 mm 7.88"x0.14"	100 pcs	gr. 90 oz. 3.2
ZX.0214	250x4,5 mm 9.85"x0.18"	100 pcs	gr. 180 oz. 6.4
ZX.0215	240x7,5 mm 9.46"x0.30"	100 pcs	gr. 370 oz. 13.1
ZX.0216	360x7,5 mm 14.18"x0.30"	100 pcs	gr. 530 oz. 18.8

***Idrobase
dal 1986***

***Abbiamo impiegato
i nostri primi
20 anni di vita
per costruirci
la barca.***

***Ora
siamo pronti
per solcare
i mercati del mondo.***

Idrobase Team

**Nuove rotte
per il
business**



**Sail into
new
business**

***Idrobase
since 1986***

***We have spent
the first 20 years
of our lives
building
our boat.***

***Now we are ready
to sail
through the markets
of the world.***

Idrobase Team



Club dei Riparatori[®]

***...Winning
mentality***

Accessories and spare parts for cleaning machines - INDEX

<i>Subject</i>		<i>Page</i>
Cleaning machines / Vacuum cleaners:	• <i>BY-PASS vacuum motors</i>	256
	• <i>TANGENTIAL BY-PASS vacuum motors</i>	257
	• <i>THRU-FLOW vacuum motors</i>	257
	• <i>Flexible hoses and tool adapters</i>	258
	• <i>Accessories for flexible hose ø32/33 mm-1.26"</i>	259
	• <i>Accessories for flexible hose ø38 mm-1.50"</i>	260
	• <i>Accessories for flexible hose ø50 mm-1.97"</i>	260
	• <i>Filter in polyester</i>	261
	• <i>Nozzle multi-function 300 mm-11.82", ø32-1.26" and 400 mm-15.76" ø38-1.50"</i>	262
	<hr/>	
Cleaning machines / Carpet cleaners:	• <i>Carpet cleaner motor-pump</i>	263
	• <i>Carpet cleaner accessories</i>	263
<hr/>		
Cleaning machines / Scrubber driers:	• <i>Scrubber driers flexible hose</i>	263
	• <i>Discs</i>	264
	• <i>Dolly squeegees fitting Comac</i>	265
	• <i>Dolly squeegees fitting Floor</i>	265
	• <i>Dolly squeegees fitting Fimap</i>	266
	• <i>Dolly squeegees fitting Tennant</i>	266
	• <i>Dolly squeegees fitting Gansow</i>	267
	• <i>Dolly squeegees fitting Nilfisk-Advance</i>	267
	• <i>Dolly squeegees fitting Cleanfix</i>	268
• <i>Dolly squeegees fitting Hako</i>	268	
<hr/>		
Cleaning machines and equipment:	• <i>Hotel cleaning equipment</i>	269

Cleaning machines / Vacuum cleaners

- BY-PASS vacuum motors

1000 W, 230 V, 50-60 Hz / wet & dry. Motors suitable for wet and dry vacuum cleaners, and mainly for vacuums fitting Elsea, Lavor, Soteco and Tron



1000 W, 230 V, 50-60 Hz / wet & dry. Motors suitable for wet and dry vacuum cleaners, and mainly for vacuums fitting Delfin, Depureco, Elsea, Fiorentini, Ghibli and Soteco.

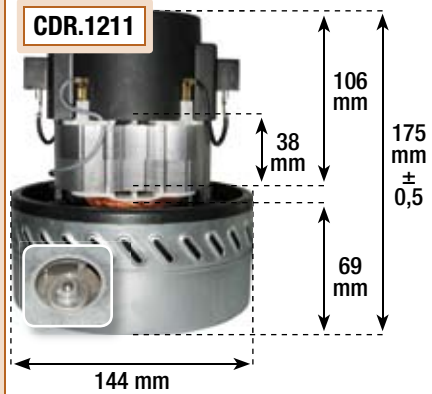

1200 W, 230 V, 50-60 Hz / wet & dry. Motors suitable for wet and dry vacuum cleaners, and mainly for vacuums fitting Delfin, Depureco, Elsea, Fiorentini, Ghibli and Soteco.

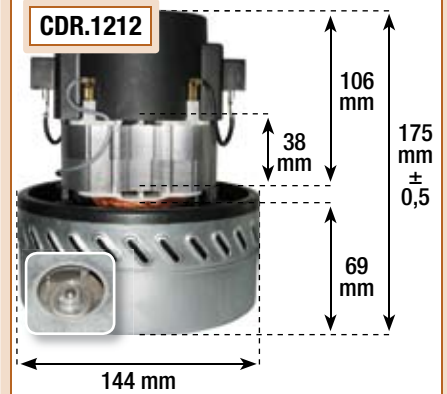

1000 W, 110 V, 50-60 Hz / wet & dry. Motors suitable for wet and dry vacuum cleaners.

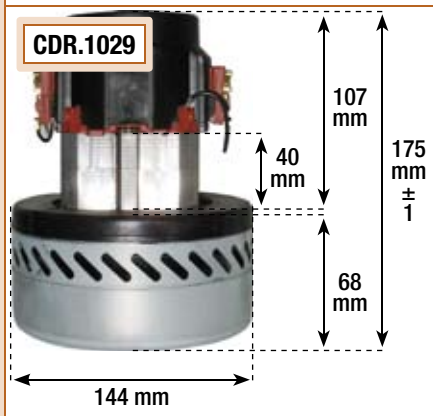

1000 W, 120 V, 50 Hz / wet & dry. Motors UL-CSA certificated, suitable for wet and dry USA and Canadian market and mainly for vacuums fitting Soteco and Tennant.

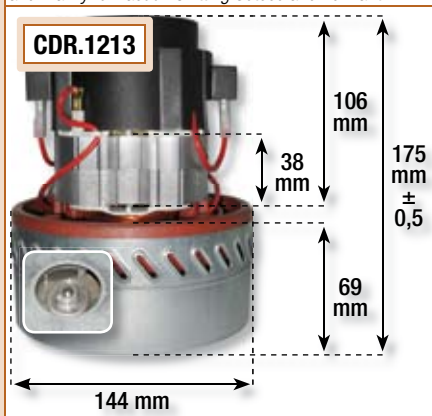

24 V, 50-60 Hz / sweepers & scrubber driers. Motors suitable for sweepers and scrubber driers mainly for those fitting Comac, Delfin, Fiorentini, Fixnet and Soteco.

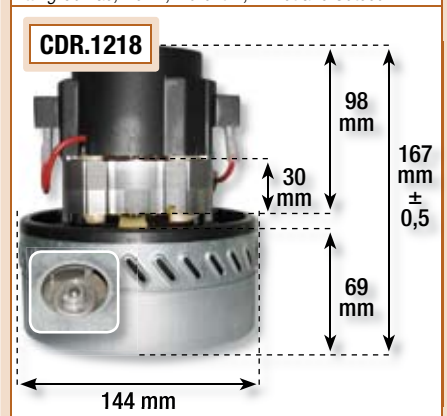

1000 W, 230 V, 50-60 Hz / wet & dry. Motors suitable for wet and dry vacuum cleaners fitting Kärcher.

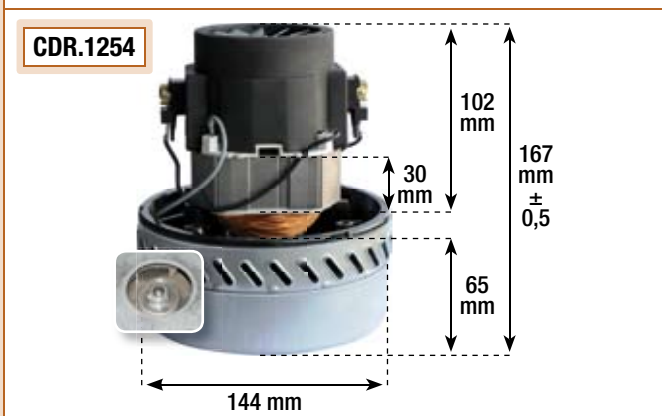

1000 W, 230 V, 50-60 Hz / dry. Motors 1 stage suitable for dry only vacuum cleaners fitting Kärcher.

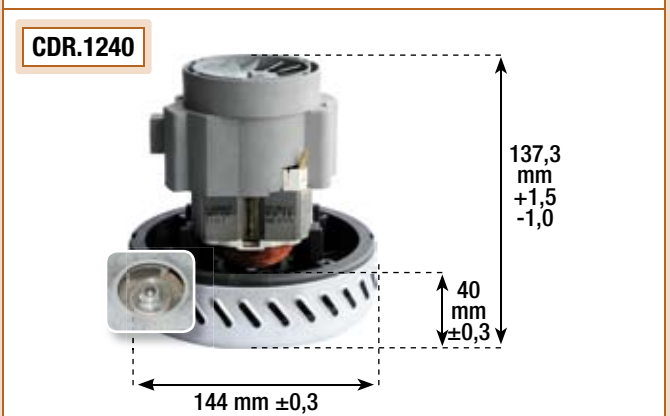

Code	Class	Stages	Volts	Watts max	Watts min	Water lift mm H ₂ O	Airflow l / sec.	Rpm open	Rpm sealed	Weight
CDR.1210	II	2	230	1100	750	2300	54	19000	24000	gr. 2000 oz. 70.6
CDR.1211	II	2	230	1100	750	2350	54	19000	24000	gr. 2200 oz. 77.7
CDR.1212	II	2	230	1250	800	2600	57	20000	25000	gr. 2050 oz. 72.4
CDR.1029	II	2	110	1000		2230	57			gr. 2450 oz. 86.5
CDR.1213	I	2	120	120	1100	750	50	18000	23000	gr. 2250 oz. 79.5
CDR.1218	I	2	24	450	300	1250	38	14000	16500	gr. 2050 oz. 72.4
CDR.1254	II	2	230	1100	768	2590	43	20200	25850	gr. 2500 oz. 87.7
CDR.1240	II	1	230	1280	750	1836	60	24500	29800	gr. 1460 oz. 51.1

Cleaning machines / Vacuum cleaners - TANGENTIAL BY-PASS vacuum motors

1000 W, 230 V, 50-60 Hz / wet & dry. Motors suitable for wet and dry vacuum cleaners, and mainly for vacuums fitting Artec, Drainvac, Netco, Rupes and Soteco.

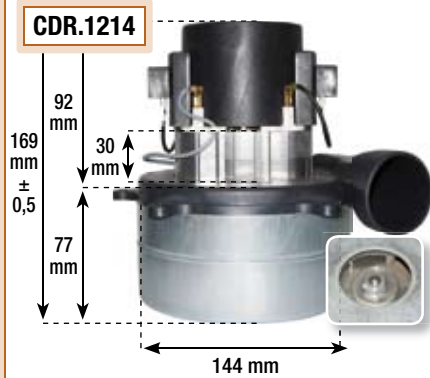

1100 W, 230 V, 50-60 Hz / wet & dry. Motors suitable for wet and dry vacuum cleaners, and mainly for vacuums fitting Netco, Jonny Vac, Soteco and Weber.

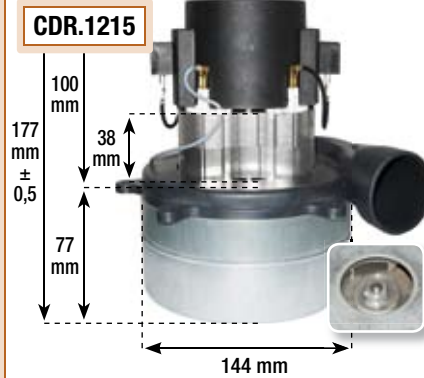

24 V, 50-60 Hz / sweepers & scrubber driers. Motors suitable for sweepers and scrubber driers mainly for those fitting Columbus, Nilfisk, Omm, Qualtex and Soteco.

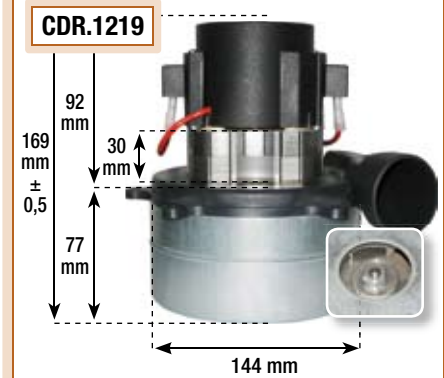

Code	Class	Stages	Volts	Watts max	Watts min	Water lift mm H ₂ O	Airflow l / sec.	Rpm open	Rpm sealed	Weight
CDR.1214	II	2	230	1100	700	2150	48	17500	23000	gr. 2000 oz. 70.6
CDR.1215	II	2	230	1150	750	2350	48	19000	24000	gr. 2250 oz. 79.5
CDR.1219	I	2	24	450	300	1250	35	13500	16000	gr. 2100 oz. 74.2

CDR.1222

Carbon brush
for vacuum motors 230 V



gr. 15
oz. 0.6

CDR.1223

Carbon brush
for vacuum motors 24 V



gr. 15
oz. 0.6

CDR.1224

Carbon brush
for vacuum motors 120 V



gr. 15
oz. 0.6

ZX.0895

Pair of carbon brushes
AUTO STOP
for vacuum motors 230 V.
Motor stops
when it is
time to change
carbon brushes



gr. 25
oz. 0.9

Quantity
1x2

Cleaning machines / Vacuum cleaners - THRU-FLOW vacuum motors

900 W, 230 V, 50-60 Hz / dry. Motors suitable for wet vacuum cleaners, and mainly for vacuum fitting Fiorentini, Phoenix, Rtm and Soteco.

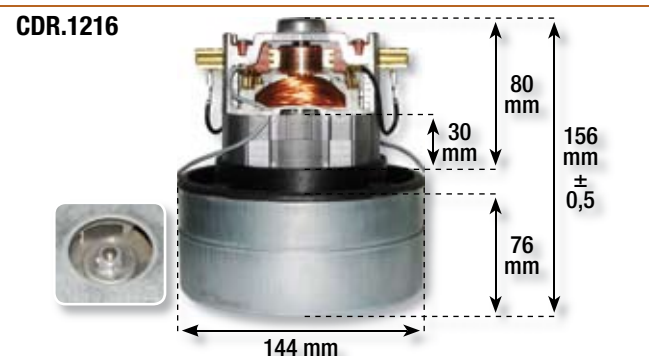

1200 W, 230 V, 50-60 Hz / dry. Motors suitable for wet and dry vacuum cleaners, and mainly for vacuum fitting Dixter, Fiorentini, Pulivax and Soteco.

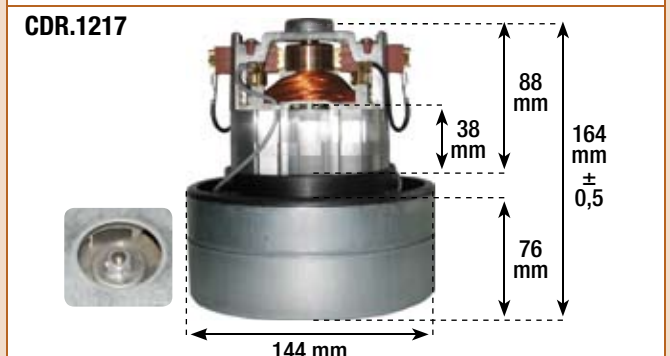

Code	Class	Stages	Volts	Watts max	Watts min	Water lift mm H ₂ O	Airflow l / sec.	Rpm open	Rpm sealed	Weight
CDR.1216	I	2	230	950	600	2100	49	17000	22000	gr. 2050 oz. 72.4
CDR.1217	I	2	230	1350	750	2550	56	20000	26000	gr. 2350 oz. 82.3

Cleaning machines / Vacuum cleaners - Flexible hoses and tool adapters

Flexible hose - In roll

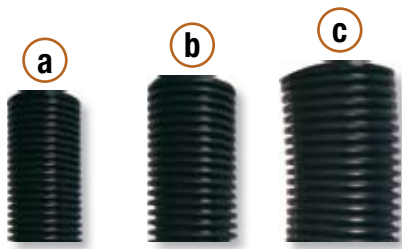

Code	ø inlet	ø outlet	Q.ty	Weight	Description
a) CDR.1024	33 mm 1.30"	36 mm 1.42"	30 m 98.40 ft	gr. 6300 oz. 222.4	Flexible spiral hose made of unreinforced ethylene vinyl acetate. Resistant to permanent deformation and blackages. Applications: suction and drawing of liquids.
b) CDR.1025	38 mm 1.50"	45 mm 1.77"	30 m 98.40 ft	gr. 10800 oz. 381.3	Flexible spiral hose made of unreinforced ethylene vinyl acetate. Resistant to permanent deformation and blackages. Applications: suction and drawing of liquids.
c) CDR.1026	50 mm 1.97"	58 mm 2.29"	30 m 98.40 ft	gr. 14400 oz. 508.4	Flexible spiral hose made of unreinforced ethylene vinyl acetate. Resistant to permanent deformation and blackages. Applications: suction and drawing of liquids.

Flexible hose - With connections

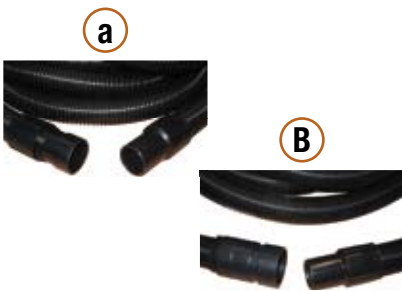

Code	ø inlet	ø outlet	Q.ty	Weight	Description
a) ZX.1004	38 mm 1.50"	45 mm 1.77"	2.5 m 8.20 ft	gr. 1000 oz. 35.3	Flexible spiral hose complete with sleeve with groove, fixed connections and semirigid tool adapter. Applications: suction and drawing of liquids.
c) ZX.1007	33 mm 1.30"	36 mm 1.42"	4 m 13.10 ft	gr. 1540 oz. 54.4	Flexible spiral hose complete with sleeve with groove, fixed connections and semirigid tool adapter. Applications: suction and drawing of liquids.

CDR.1030

Semirigid tool adapter,
for flexible hose,
internal ø32/33 mm
1.26"
(code CDR.1024)



gr. 50
oz. 1.8

minimum quantity
10 pcs

CDR.1031

Semirigid tool adapter,
for flexible hose,
internal ø38 mm
1.50"
(code CDR.1025)



gr. 50
oz. 1.8

minimum quantity
10 pcs

CDR.1032

Semirigid tool adapter,
for flexible hose,
internal ø50 mm
1.97"
(code CDR.1026)



gr. 165
oz. 5.9

minimum quantity
10 pcs

Cleaning machines / Vacuum cleaners - Inlet accessories for vacuum cleaners

Adapters, sleeves and accessories made of PVC.

CDR.1038

PP vacuum socket



gr. 85
oz. 3.0

minimum quantity
10 pcs

CDR.1039

Rubber gasket,
fo vacuum socket
(code CDR.1038)



gr. 25
oz. 0.9

minimum quantity
10 pcs

CDR.1009

Rigid sleeve with groove,
fixed connections,
for flexible hose
ø32/33 mm-1.26"
(code CDR.1024)



gr. 50
oz. 1.8

minimum quantity
10 pcs

CDR.1010

Rigid sleeve with groove,
swivel connections,
for flexible hose
ø32/33 mm-1.26"
(code CDR.1024)



gr. 55
oz. 2.0

minimum quantity
10 pcs

CDR.1040

Rigid sleeve with groove,
fixed connections,
for flexible hose
ø38 mm-1.50"
(code CDR.1025)



gr. 50
oz. 1.8

minimum quantity
10 pcs

Cleaning machines / Vacuum cleaners

- Accessories for flexible hose $\varnothing 32/33$ mm-1.26"

Adapters, sleeves and accessories made of PVC.

CDR.1006

Handle grip with air regulator,
280 mm-11.1",
swivel inlet connection,
for flexible hose $\varnothing 32/33$ mm-1.26"
(code CDR.1024)
outlet $\varnothing 36$ mm-1.42"



gr. 105
oz. 3.7

minimum quantity
10 pcs

CDR.1030

Semirigid tool adapter,
for flexible hose,
internal $\varnothing 32/33$ mm-1.26"
(code CDR.1024)



gr. 165
oz. 5.9

minimum quantity
10 pcs

BE CAREFUL !!!



The accessories for vacuum cleaners external $\varnothing 36$ mm-1.42", are suitable for flexible hose internal $\varnothing 32/33$ -1.26".

CDR.1005

Rigid tool adapter,
swivel inlet connection
for flexible hose $\varnothing 32/33$ mm-1.26"
(code CDR.1024)
outlet $\varnothing 36$ mm-1.42"



gr. 45
oz. 1.6

minimum quantity
10 pcs

CDR.1007

Rigid tool adapter,
swivel inlet connections,
for flexible hose
internal $\varnothing 32/33$ mm
1.26"
(code CDR.1024)
outlet $\varnothing 58$ mm-2.29"



gr. 55
oz. 2.0

minimum quantity
10 pcs

CDR.1008

Rigid tool adapter,
swivel inlet connections,
for flexible hose
internal $\varnothing 32/33$ mm
1.26"
(code CDR.1024)
outlet $\varnothing 58$ mm-2.29",
with pin



gr. 45
oz. 1.6

minimum quantity
10 pcs

CDR.1009

Sleeve with goove,
fixed inlet connection
for flexible hose
internal $\varnothing 32/33$ mm
1.26"
(code CDR.1024),
suitable for vacuum socket
(code CDR.1038)



gr. 50
oz. 1.8

minimum quantity
10 pcs

CDR.1010

Sleeve with goove,
swivel inlet connection
for flexible hose
internal $\varnothing 32/33$ mm
1.26"
(code CDR.1024),
suitable for vacuum socket
(code CDR.1038)



gr. 55
oz. 2.0

minimum quantity
10 pcs

CDR.1001

Little nozzle,
140 mm,
inlet $\varnothing 36$ mm-1.42"



gr. 45
oz. 1.6

minimum quantity
10 pcs

CDR.1002

Dusting brush,
inlet $\varnothing 36$ mm-1.42"



gr. 40
oz. 1.5

minimum quantity
10 pcs

CDR.1003

Crevice tool,
210 mm-8.28",
inlet $\varnothing 36$ mm-1.42"



gr. 30
oz. 1.1

minimum quantity
10 pcs

CDR.1004

Extension wand,
500 mm-19.7",
 $\varnothing 36$ mm-1.42"



gr. 120
oz. 4.3

minimum quantity
10 pcs

Cleaning machines / Vacuum cleaners - Accessories for flexible hose $\varnothing 38$ mm-1.5"

Adapters, sleeves and accessories made of PVC.

CDR.1019

Handle grip with air regulator,
300 mm-11.9",
swivel inlet connection,
for flexible hose $\varnothing 38$ mm-1.5"
(code CDR.1025)
outlet $\varnothing 45$ mm-1.78"



gr. 140 *minimum quantity*
oz. 5.0 10 pcs

CDR.1031

Semirigid tool adapter,
for flexible hose,
internal $\varnothing 38$ mm-1.5"
(code CDR.1025)



gr. 50 *minimum quantity*
oz. 1.8 10 pcs

BE CAREFUL !!!



The accessories for vacuum cleaners, external $\varnothing 45$ mm-1.78" are suitable for flexible hoses internal $\varnothing 38$ mm-1.5".

CDR.1020

Rigid tool adapter,
swivel inlet connection
for flexible hose $\varnothing 38$ mm-1.5"
(code CDR.1025)
outlet $\varnothing 45$ mm-1.78"



gr. 70 *minimum quantity*
oz. 2.5 10 pcs

CDR.1021

Rigid tool adapter,
swivel inlet connections,
for flexible hose
internal $\varnothing 38$ mm-.5"
(code CDR.1025)
outlet $\varnothing 52$ mm-2.05"



gr. 70 *minimum quantity*
oz. 2.5 10 pcs

CDR.1022

Rigid tool adapter,
swivel inlet connections,
for flexible hose
internal $\varnothing 38$ mm-1.5"
(code CDR.1025)
outlet $\varnothing 52$ mm-2.05",
with pin



gr. 50 *minimum quantity*
oz. 1.8 10 pcs

CDR.1023

Rigid tool adapter
inlet $\varnothing 45$ mm-1.78"
outlet $\varnothing 36$ mm-1.42"



gr. 45 *minimum quantity*
oz. 1.6 10 pcs

CDR.1049

Rigid tool adapter
inlet $\varnothing 45$ mm-1.78"
outlet $\varnothing 32$ mm-1.26"



gr. 40 *minimum quantity*
oz. 1.5 10 pcs

CDR.1016

Dusting brush,
inlet $\varnothing 45$ mm-1.78"



gr. 65 *minimum quantity*
oz. 2.3 10 pcs

CDR.1017

Crevice tool,
250 mm-9.85",
inlet $\varnothing 45$ mm-1.78"



gr. 70 *minimum quantity*
oz. 2.5 10 pcs

CDR.1018

Extension wand,
500 mm-19.7",
 $\varnothing 45$ mm-1.78"



gr. 155 *minimum quantity*
oz. 5.5 10 pcs

Cleaning machines / Vacuum cleaners - Accessories for flexible hose $\varnothing 50$ mm-1.97"

Adapters, sleeves and accessories made of PVC.

CDR.1290

Rigid tool adapter
inlet $\varnothing 51,5$ mm-1.2.03"
outlet $\varnothing 57$ mm-2.25"



gr. 50 *minimum quantity*
oz. 1.8 10 pcs

CDR.1289

Dusting brush,
inlet $\varnothing 51,5$ mm-2.03"



gr. 80 *minimum quantity*
oz. 2.8 10 pcs

CDR.1088

Crevice tool,
250 mm-9.85",
inlet $\varnothing 51,5$ mm-2.03"



gr. 90 *minimum quantity*
oz. 3.2 10 pcs

BE CAREFUL !!!



The accessories for vacuum cleaners, external $\varnothing 51,5$ mm-2.03" are suitable for flexible hoses internal $\varnothing 50$ mm-1.97".

Cleaning machines / Vacuum cleaners

- Filter in polyester



Filter in polyester, complete with metal fixing ring,
density 0,33 g/cm², thickness 1,35
CONE shaped

Code	A ø higher	B ø lower	C height	U.m.	Model	Weight
CDR.1300	38	24	33	cm	For vacuum cleaners fitting: SOTECO 400 series (conical)	gr. 200
	14.97	9.46	13.00	in		oz. 7.0
CDR.1301	25	12	22	cm	For vacuum cleaners fitting: SOTECO 300 series	gr. 90
	9.85	4.73	8.67	in		oz. 3.2

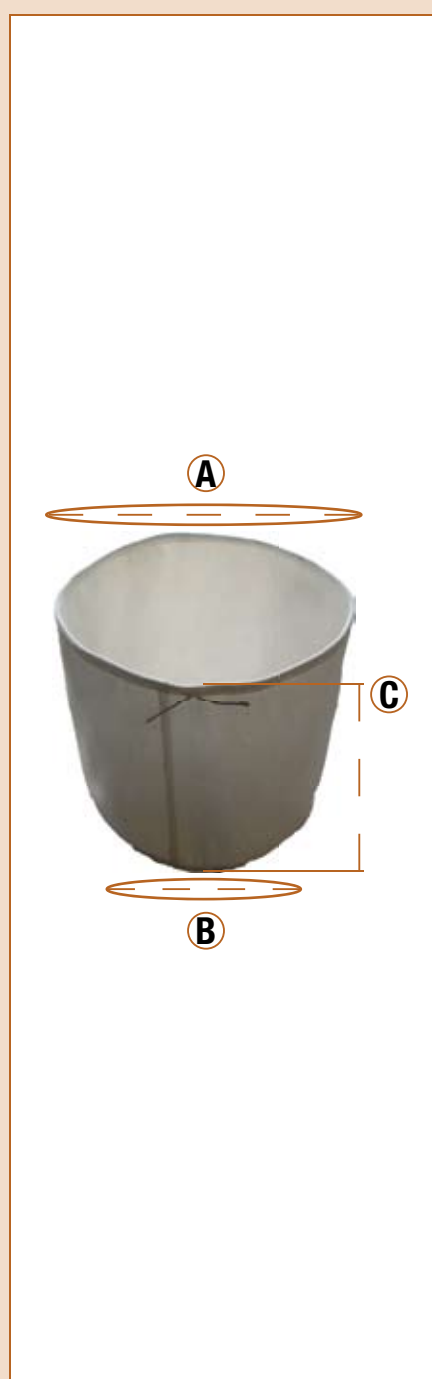

Filter in polyester, complete with metal fixing ring,
density 0,33 g/cm², thickness 1,35
CYLINDRICAL

Code	A ø higher	B ø lower	C height	U.m.	Model	Weight
CDR.1302	36,5	36,5	35	cm	For vacuum cleaners fitting: SOTECO 400 series (cylindrical), GHIBLI (58 lt) and WIRBEL (mod. 950)	gr. 220
	14.38	14.38	13.79	in		oz. 7.7
CDR.1303	24	24	28	cm	For vacuum cleaners fitting: SOTECO (H=260 cylindrical)	gr. 180
	9.46	9.46	11.03	in		oz. 6.3
CDR.1304	24	24	21	cm	For vacuum cleaners fitting: SOTECO (H=180 cylindrical)	gr. 120
	9.46	9.46	8.27	in		oz. 4.2
CDR.1305	24	24	9	cm	For vacuum cleaners fitting: SOTECO (H=75 cylindrical)	gr. 50
	9.46	9.46	3.55	in		oz. 1.8
CDR.1306	24,5	24,5	25	cm	For vacuum cleaners fitting: Wirbel (mod. 914-929)	gr. 180
	9.65	9.65	9.85	in		oz. 6.3
CDR.1307	24,5	24,5	12	cm	For vacuum cleaners fitting: GHIBLI (12 lt) and WIRBEL (mod. 909)	gr. 90
	9.65	9.65	4.73	in		oz. 3.2
CDR.1308	24,5	24,5	32	cm	For vacuum cleaners fitting: GHIBLI (27 lt)	gr. 220
	9.65	9.65	12.60	in		oz. 7.7
CDR.1309	35	35	30	cm	For vacuum cleaners fitting: GHIBLI (mod. WD 400)	gr. 200
	13.79	13.79	11.82	in		oz. 7.0
CDR.1310	34	34	49	cm	For vacuum cleaners fitting: GHIBLI (mod. AS27)	gr. 280
	13.40	13.40	19.30	in		oz. 9.8

Cleaning machines / Vacuum cleaners

- Nozzle multi-function 300 mm \varnothing 32 mm-1.26"

Professional accessories nozzles multi-function made of shock-proof material

CDR.1011

Nozzle multi-function 300 mm-11.82",
inlet \varnothing 36 mm-1.42,
with castors and
quick connection
for cleaning brush



gr. 180
oz. 6.6

CDR.1012

Nozzle multi-function 300 mm-11.82",
inlet \varnothing 45 mm-1.78",
with castors
and quick connection
for cleaning brush



gr. 190
oz. 6.7

CDR.1013

FLOOR cleaning brush,
for multi-function nozzle 300 mm-11.82"
(code CDR.1011-CDR.1012)



gr. 150
oz. 5.3

CDR.1014

LIQUID SUCTION cleaning brush,
for multi-function nozzle 300 mm-11.82"
(code CDR.1011-CDR.1012)



gr. 115
oz. 4.1

CDR.1015

CARPETS cleaning brush,
for multi-function nozzle 300 mm-11.82"
(code CDR.1011-CDR.1012)



gr. 145
oz. 5.2

Cleaning machines / Vacuum cleaners

- Nozzle multi-function 400 mm \varnothing 38 mm-1.5"

Professional accessories nozzles multi-function made of shock-proof material

CDR.1041

Nozzle multi-function 400 mm-15.8",
only body, with castors
and quick connections
for cleaning brush



gr. 1500
oz. 5.3

CDR.1042

Adapter fitting Ghibli,
outlet \varnothing 38 mm-1.5", for multi-function nozzle
(code CDR.1011-CDR.1012-CDR.1041)



gr. 25
oz. 0.9

CDR.1043

Adapter fitting Lavor,
outlet \varnothing 38 mm-1.5", for multi-function nozzle
(code CDR.1011-CDR.1012-CDR.1041)



gr. 40
oz. 1.5

CDR.1044

FLOOR cleaning brush,
for multi-function nozzle 400 mm-15.8"
(code CDR.1041)



gr. 175
oz. 6.2

CDR.1045

LIQUID SUCTION cleaning brush,
for multi-function nozzle 400 mm-15.8"
(code CDR.1041)



gr. 145
oz. 5.2

CDR.1046

CARPETS cleaning brush,
for multi-function nozzle 400 mm-15.8"
(code CDR.1041)



gr. 165
oz. 5.9

Cleaning machines / Vacuum cleaners

- Nozzles multi-function

CDR.1048

Nozzle multi-function, 270 mm-10.7",
top of the body shock-proof material
bottom of the body
steel with velvets and strip,
inlet \varnothing 32 mm-1.26"



gr. 400
oz. 14.2

CDR.1047

Nozzle multi-function, 270 mm-10.7",
top of the body shock-proof material
bottom of the body
steel with velvets and strip,
inlet \varnothing 36 mm-1.42"



gr. 410
oz. 14.5

Cleaning machines / Carpet cleaners

- Carpet cleaner motor-pump

CDR.1220

Motor-pump for carpet cleaner,
230 V, 50-60 Hz, 90 Watt,
for use **without acid** products



gr. 2450
oz. 86.5

Suitable for carpet cleaners, mainly fitting Dama, Elsea,
Hansung, Nilfisk and Soteco

CDR.1221

Motor-pump for carpet cleaner,
230 V, 50-60 Hz, 90 Watt,
for use **with acid** products



(it is better to send us
a technical leaflet of the product
to verify how it should be used)

gr. 2450
oz. 86.5

Suitable for carpet cleaners, mainly fitting Dama, Elsea,
Hansung, Nilfisk and Soteco

Cleaning machines / Carpet cleaners

- Carpet cleaner accessories

CDR.1199

Flexible hose 1,7 m-5.58',
ø32 mm-1.26" inlet,
complete with handle grip
with air regulator
and trigger for the flow
of the detergent



gr. 900
oz. 31.8

PVC flexible hose with steel covered spiral
and integrated polyurethane hose for flow of detergents.

CDR.1200

Rigid extension hose 440 mm-15.76",
ø37 mm-1.46",
for code CDR.1199



gr. 190
oz. 6.7

Made of PVC

CDR.1201

Carpet cleaners little nozzle 240 mm-9.45",
ø37 mm-1.46", for code CDR.1200



gr. 300
oz. 10.6

Complete with variable angle nozzle
for detergent, 110°, flow rate 03

CDR.1202

Armchair little nozzle 90 mm-3.55",
ø37 mm-1.46",
for code CDR.1199



gr. 140
oz. 5.0

Complete with variable angle nozzle
for detergent, 110°, flow rate 02

CDR.1203

Frame with strip and squeegees
for code CDR.1201



gr. 80
oz. 2.9

Cleaning machines / Scrubber driers

- Scrubber driers flexible hose

CDR.1204

Flexible spiral hose,
15 m-49.20' in roll,
ø32 mm-1.26" inlet, ø37 mm-1.46" outlet



gr. 4680
oz. 165.2

Hose with covered steel hose
and textile support

CDR.1205

Flexible spiral hose,
15 m-49.20' in roll,
ø38 mm-1.50" inlet, ø44 mm-1.73" outlet



gr. 5600
oz. 197.7

Hose with covered steel hose
and textile support

CDR.1206

Flexible spiral hose,
15 m-49.20' in roll,
ø50 mm inlet, ø57 mm outlet



gr. 3660
oz. 129.2

Hose with covered steel hose
and textile support

CDR.1207

Semi-rigid adapter with thread,
for flexible spiral hose
ø32 mm-1.26"
(code CDR. 1204)



gr. 65
oz. 2.3

CDR.1208

Semi-rigid adapter with thread,
for flexible spiral hose
ø38 mm 1.50"
(code CDR. 1205)



gr. 70
oz. 2.5

CDR.1209

Semi-rigid adapter with thread,
for flexible spiral hose
ø50 mm-1.97"
(code CDR. 1206)



gr. 105
oz. 3.8

Cleaning machines / Carpet cleaners

Carpet cleaner motor-pump

CDR.0503

Carpet cleaner pump fitting Soteco,
230 V, 50 Hz,
inlet ø7,5 mm,
outlet ø14 mm / G 1/8" M



gr. 460
oz. 5.7

*Inlet and outlet hose-barb made of plastic and O-Ring in VITON.
Suitable for carpet cleaners fitting **Soteco**.*

CDR.0504

Carpet cleaner pump fitting Ghibli,
230 V, 50 Hz,
inlet ø7,5 mm,
outlet ø14 mm / G 1/8" M



gr. 460
oz. 5.7

*Inlet and outlet hose-barb made of plastic and O-Ring in VITON.
Suitable for carpet cleaners fitting **Ghibli**.*

Cleaning machines / Scrubber driers Floor machines

- Pads

WHITE	BEIGE	RED	BLUE	GREEN	BROWN	BLACK	ø disc	Minimum package
Code								pcs
CDR.1101	CDR.1111	CDR.1121	CDR.1131	CDR.1141	CDR.1151	CDR.1161	10.0" / 254 mm	10
CDR.1102	CDR.1112	CDR.1122	CDR.1132	CDR.1142	CDR.1152	CDR.1162	10.5" / 265 mm	10
CDR.1103	CDR.1113	CDR.1123	CDR.1133	CDR.1143	CDR.1153	CDR.1163	11.0" / 280 mm	10
CDR.1104	CDR.1114	CDR.1124	CDR.1134	CDR.1144	CDR.1154	CDR.1164	12.0" / 305 mm	5
CDR.1105	CDR.1115	CDR.1125	CDR.1135	CDR.1145	CDR.1155	CDR.1165	13.0" / 330 mm	5
CDR.1106	CDR.1116	CDR.1126	CDR.1136	CDR.1146	CDR.1156	CDR.1166	13.5" / 340 mm	5
CDR.1107	CDR.1117	CDR.1127	CDR.1137	CDR.1147	CDR.1157	CDR.1167	14.0" / 356 mm	5
CDR.1108	CDR.1118	CDR.1128	CDR.1138	CDR.1148	CDR.1158	CDR.1168	15.0" / 381 mm	5
CDR.1109	CDR.1119	CDR.1129	CDR.1139	CDR.1149	CDR.1159	CDR.1169	16.0" / 406 mm	5
CDR.1110	CDR.1120	CDR.1130	CDR.1140	CDR.1150	CDR.1160	CDR.1170	17.0" / 431 mm	5
CDR.1171	CDR.1175	CDR.1179	CDR.1183	CDR.1187	CDR.1191	CDR.1195	18.0" / 457 mm	5
CDR.1172	CDR.1176	CDR.1180	CDR.1184	CDR.1188	CDR.1192	CDR.1196	19.0" / 483 mm	5
CDR.1173	CDR.1177	CDR.1181	CDR.1185	CDR.1189	CDR.1193	CDR.1197	20.0" / 508 mm	5
CDR.1174	CDR.1178	CDR.1182	CDR.1186	CDR.1190	CDR.1194	CDR.1198	21.0" / 533 mm	5

FINISHING



*Nylon
Polyester*

*Not-abrasive pad,
suitable to polish untreated floors
and high gloss finishing.
Use dry.*

POLISHING



*Nylon
Polyester*

*To polish
all kinds of floor.
Use dry.*

SPRAY BUFFING



Polyester

*For frequent use
on relatively clean floors.
To dry clean, polish and remove
cuff marks.*

LIGHT CLEANING ACTION



*Nylon
Polyester*

*Light wax removal
or spray washing.*

INTERMEDIATE CLEANING ACTION



Nylon

*Wet scrubbing operation
to remove all dirty finish and
to obtain floors readying
for recoating.*

DRY AND WET STRIPPING



Nylon

*Aggressive pad
for dry and wet stripping.
Very durable.
Acid resistant.*

WET STRIPPING



Nylon

*Wet stripping
for normal or heavy layers of wax,
to completely remove old floor
finish and scuff marks.*

*The range of professional discs here
listed is indicative and it summarizes
discs by size and kind of material, the
most common on the cleaning world.
If you need discs with different sizes
and / or kind of material not men-
tioned here, please, feel free to*

CONTACT US



P/B

BEIGE PARA:
It is used for some back Dolly squeegees fitting Comac. Para that we use has a thickness from 3 mm-0.12" to 10 mm-0.39" and temperature resistance from -10 °C(50 °F) to +60 °C (140 °F).



P/R

RED PARA:
It is used for some back Dolly squeegees fitting Comac. Para that we use has a thickness from 3 mm-0.12" to 10 mm-0.39" and temperature resistance from -10 °C(50 °F) to +60 °C (140 °F).



PU/T

TRANSPARENT POLYURETHANE (PU):
It is used for some front Dolly squeegees fitting Comac. Polyurethane that we use has a thickness from 3 mm-0.12" to 8 mm-0.32" and temperature resistance from -30 °C (85 °F) to +70 °C (160 °F).

Dolly squeegees fitting: COMAC		Sizes L x H x P	Material																					
Code	Description			Abila 17	Abila 42	Abila 52	C 45 E	CB 40	CB 50	Media 22 E	Media 22 B	Media 26 B	Omina 22 E	Ominia 22 B	Ominia 26	Ominia 28	Ominia 32	Simple 45 E	Simple 45 B	Simple 45 BT	Simple 45 BS	Simple 50 B	Simple 50 BT	Simple 50 BS
CDR.1050-F	Dolly squeegees - front	667 x 45 mm 26.23" x 1.77"	PU/T	•	•	•	•										•	•	•	•				
CDR.1050-B	Dolly squeegees - back	681 x 45 x 4 mm 26.83" x 1.77" x 0.16"	P/R	•	•	•	•										•	•	•	•				
CDR.1050-S	Dolly squeegees - support	684 x 34 mm 26.95" x 1.34"	PU/T	•	•	•	•										•	•	•	•				
CDR.1051-F	Dolly squeegees - front	767 x 45 mm 30.22" x 1.77"	PU/T			•		•													•	•	•	•
CDR.1051-B	Dolly squeegees - back	781 x 45 x 4 mm 30.77" x 1.77"	P/B			•		•													•	•	•	•
CDR.1051-S	Dolly squeegees - support	784 x 34 mm 30.89" x 1.34"	PU/T			•		•													•	•	•	•
CDR.1052-F	Dolly squeegees - front	810 x 45 mm 31.91" x 1.77"	PU/T							•	•		•	•										
CDR.1052-B	Dolly squeegees - back	848 x 95 x 6 mm 33.41" x 3.74" x 0.24"	P/B							•	•		•	•										
CDR.1053-F	Dolly squeegees - front	912 x 45 mm 35.93" x 1.77"	PU/T										•											
CDR.1053-B	Dolly squeegees - back	952 x 95 x 6 mm 37.51" x 3.74" x 0.24"	P/B										•											
CDR.1054-F	Dolly squeegees - front	1026 x 45 mm 40.42" x 1,77"	PU/T														•	•						
CDR.1054-B	Dolly squeegees - back	1052 x 95 x 6 mm 41.45" x 3.74" x 0.24"	P/R														•	•						
CDR.1055-F	Dolly squeegees - front	1134 x 45 mm 44.68" x 1.77"	PU/T														•							
CDR.1055-B	Dolly squeegees - back	1156 x 95 x 6 mm 45.55" x 3.74" x 0.24"	P/R														•							



P/W

WHITE PARA:
It is used for some back Dolly squeegees fitting Comac. Para that we use has a thickness from 3 mm-0.12" to 10 mm-0.39" and temperature resistance from -10 °C(50 °F) to + 60 °C (140 °F).



L/R

RED LEENATEX:
It is used for some front and back Dolly squeegees fitting Floor.

Dolly squeegees fitting: FLOOR		Sizes L x H x P	Material			
Code	Description			PANTHER 70	SHARK 54	SHARK 57
CDR.1060-F	Dolly squeegees - front	895 x 54 x 3 mm 35.26" x 2.13" x 0.12"	P/W		•	•
CDR.1060-B	Dolly squeegees - back	890 x 54 x 3 mm 35.07" x 2.13" x 0.12"	L/R		•	•
CDR.1061-F	Dolly squeegees - front	1020 x 54 x 3 mm 40.19" x 2.13" x 0.12"	L/R	•		
CDR.1061-B	Dolly squeegees - back	1010 x 54 x 3 mm 39.79" x 2.13" x 0.12"	L/R	•		



P/R

RED PARA:
It is used for some back Dolly squeegees fitting Fimap.
Para that we use has a thickness from 3 mm-0.12" to 10 mm-0.39" and temperature resistance from -10 °C (50 °F) to +60 °C (140 °F).



PU/T

TRANSPARENT POLYURETHANE (PU):
It is used for some front and support Dolly squeegees fitting Fimap.
Polyurethane that we use has a thickness from 3 mm-0.12" to 8 mm-0.32" and temperature resistance from -30 °C (85 °F) to +70 °C (160 °F).

Dolly squeegees fitting: FIMAP		Sizes L x H x P	Material	Gamma 45 E	Gamma 50 E	Gamma 56	Gamma 65	Gamma 66	Maxima 45 BS	Maxima 45 BST	Maxima 50 BS	Maxima 50 BST	Maxima 450 B	Maxima 450 BT	Maxima 452 B	Maxima 452 BT	Maxima 500 B	Maxima 500 BT	Maxima 502 B	Maxima 502 BT	Mimny 420	Mimny 430	Mimny 520	Valida 66
Code	Description			Gamma 45 E	Gamma 50 E	Gamma 56	Gamma 65	Gamma 66	Maxima 45 BS	Maxima 45 BST	Maxima 50 BS	Maxima 50 BST	Maxima 450 B	Maxima 450 BT	Maxima 452 B	Maxima 452 BT	Maxima 500 B	Maxima 500 BT	Maxima 502 B	Maxima 502 BT	Mimny 420	Mimny 430	Mimny 520	Valida 66
CDR.1056-F	Dolly squeegees - front	670 x 45 mm 26.40" x 1.77"	PU/T	•									•	•	•	•					•	•	•	
CDR.1056-B	Dolly squeegees - back	685 x 45 x 4 mm 27.00" x 1.77" x 0.16"	P/R	•									•	•	•	•					•	•	•	
CDR.1056-S	Dolly squeegees - support	885 x 32 mm 34.90" x 1.26"	PU/T	•									•	•	•	•					•	•	•	
CDR.1057-F	Dolly squeegees - front	770 x 45 mm 30.34" x 1.77"	PU/T	•					•	•	•	•					•	•	•	•	•	•	•	•
CDR.1057-B	Dolly squeegees - back	795 x 45 x 4 mm 31.32" x 1.77" x 0.16"	P/B	•					•	•	•	•					•	•	•	•	•	•	•	•
CDR.1057-S	Dolly squeegees - support	790 x 32 mm 31.13" x 1.26"	PU/T	•					•	•	•	•					•	•	•	•	•	•	•	•
CDR.1058-F	Dolly squeegees - front	885 x 45 mm 34.87" x 1.77"	PU/T			•																		
CDR.1058-B	Dolly squeegees - back	915 x 95 x 6 mm 36.05" x 3.74" x 0.24"	P/B			•																		
CDR.1059-F	Dolly squeegees - front	1030 x 45 mm 40.58" x 1.77"	PU/T				•	•																•
CDR.1059-B	Dolly squeegees - back	1055 x 95 x 6 mm 41.57" x 3.74" x 0.24"	P/R				•	•																•



P/B

BEIGE PARA:
It is used for some back Dolly squeegees fitting Tennant.
Para that we use has a thickness from 3 mm-0.12" to 10 mm-0.39" and temperature resistance from -10 °C (50 °F) to +60 °C (140 °F).



L/R

RED LEENATEX:
It is used for some front and back Dolly squeegees fitting Tennant.

Dolly squeegees fitting: TENNANT		Sizes L x H x P	Material	5100	5300	5700 (700)	5700 (800)	5700 (900)
Code	Description			5100	5300	5700 (700)	5700 (800)	5700 (900)
CDR.1093-F	Dolly squeegees - front	670 x 58 x 3 mm 26.40" x 2.29" x 0.12"	L/R	•				
CDR.1093-B	Dolly squeegees - back	683 x 79 x 5 mm 26.91" x 3.11" x 0.20"	P/B	•				
CDR.1094-F	Dolly squeegees - front	763 x 46 x 3 mm 30.06" x 1.81" x 0.12"	L/R		•			
CDR.1094-B	Dolly squeegees - back	808 x 70 x 5 mm 31.84" x 2.76" x 0.20"	P/B		•			
CDR.1095-F	Dolly squeegees - front	990 x 50 x 3 mm 39.00" x 1.97" x 0.12"	L/R			•		
CDR.1095-B	Dolly squeegees - back	1040 x 51 x 6 mm 40.98" x 2.00" x 0.24"	P/B			•		
CDR.1096-F	Dolly squeegees - front	1115 x 50 x 3 mm 43.93" x 1.97" x 0.12"	L/R				•	
CDR.1096-B	Dolly squeegees - back	1160 x 51 x 6 mm 45.70" x 2.00" x 0.24"	P/B				•	
CDR.1097-F	Dolly squeegees - front	1225 x 50 x 3 mm 48.26" x 1.97" x 0.12"	L/R					•
CDR.1097-B	Dolly squeegees - back	1255 x 51 x 6 mm 49.45" x 2.00" x 0.24"	P/B					•



PVC

YELLOW PVC:
It is used for some front Dolly squeegees fitting Gansow. PVC that we use has a thickness of 3 mm-0.12" and a temp. resistance from -10 °C(50 °F) to +60 °C (140 °F).



P/LB

LIGHT BEIGE PARA:
It is used for some back Dolly squeegees fitting Gansow. Para that we use has a thickness from 3 mm-0.12" to 10 mm-0.39" and a temp. resistance from -10 °C(50 °F) to +60 °C (140 °F).

Dolly squeegees fitting: GANSOW			Material														
Code	Description	Sizes L x H x P		26 B 46	40 B 53	62 B 53	62 B 55	62 BF 53	62 BF 65	70 BF 70	70 BF 85	88 BF 70	88 BF 85	97 BF 70	97 BF 85	119 BF 70	119 BF 85
CDR.1063-F	Dolly squeegees - front	792 x 56,5 x 3 mm 31.20" x 2.23 x 0.12"	PVC	•													
CDR.1063-B	Dolly squeegees - back	800 x 66 x 7 mm 31.52" x 2.60 x 0.28"	P/LB	•													
CDR.1064-F	Dolly squeegees - front	890 x 56,5 x 3 mm 35.07" x 2.23 x 0.12"	PVC	•													
CDR.1064-B	Dolly squeegees - back	890 x 65 x 6 mm 35.07" x 2.56 x 0.24"	P/LB	•													
CDR.1065-F	Dolly squeegees - front	953 x 55 x 3 mm 37.55" x 2.17 x 0.12"	PVC		•	•	•	•									
CDR.1065-B	Dolly squeegees - back	970 x 65 x 6 mm 38.22" x 2.56 x 0.24"	P/LB		•	•	•	•									
CDR.1066-F	Dolly squeegees - front	1050 x 56,5 x 3 mm 41.37" x 2.23 x 0.12"	PVC						•	•	•	•					
CDR.1066-B	Dolly squeegees - back	1050 x 66 x 6 mm 41.37" x 2.60 x 0.24"	P/LB						•	•	•	•					
CDR.1067-F	Dolly squeegees - front	1190 x 56,5 x 3 mm 46.89" x 2.23 x 0.12"	PVC							•	•	•	•				
CDR.1067-B	Dolly squeegees - back	1190 x 56 x 6 mm 46.89" x 2.21 x 0.24"	P/LB							•	•	•	•				



EPDM

BLACK EPDM:
It is used for some Dolly squeegees fitting Nilfisk-Advance. EPDM that we used has a thickness from 2 mm-0.08" to 3 mm-0.12" and temperature resistance from -30°C (85°F) to +70°C (160°F).



R/B

BLACK RUBBER:
It is used for front Dolly squeegees fitting Nilfisk-Advance. Rubber that we used has a thickness from 2 mm-0.08" to 3 mm-0.12" and temperature resistance from -10°C (50°F) to +60°C (140°F).



P/GY

GREY PARA:
It is used for some back Dolly squeegees fitting Nilfisk-Advance. Para that we used has a thickness from 3 mm-0.12" to 8 mm-0.32" and temperature resistance from -10°C (50°F) to +60°C (140°F).

Dolly squeegees fitting: NILFISK-ADVANCE			Material											
Code	Description	Sizes L x H x P		BA 430 S	BA 450	BA 510 S	BA 530	BA 600 S	BA 600 SC	BA 650 S	BA 750 S	CA 430 S	CA 450	CA 510 S
CDR.1072-F	Dolly squeegees - front	830 x 60 x 4 mm 32.70" x 2.36" x 0.16"	EPDM	•	•	•	•					•	•	•
CDR.1072-B	Dolly squeegees - back	795 x 60 x 2 mm 31.32" x 2.36" x 0.08"	P/GY	•	•	•	•					•	•	•
CDR.1073-F	Dolly squeegees - front	880 x 60 x 3 mm 34.67" x 2.36" x 0.12"	R/B					•	•	•				
CDR.1073-B	Dolly squeegees - back	918 x 60 x 4 mm 36.17" x 2.36" x 0.16"	P/GY					•	•	•				
CDR.1073-SG	Dolly squeegees - s.g.	147 x 44 x 4 mm 5.79" x 1.73" x 0.16"	P/GY					•	•	•				
CDR.1074-F	Dolly squeegees - front	960 x 60 x 3 mm 37.82" x 2.36" x 0.12"	R/B								•			
CDR.1074-B	Dolly squeegees - back	1000 x 60 x 4 mm 39.40" x 2.36" x 0.16"	P/GY								•			
CDR.1074-SG	Dolly squeegees - s.g.	147 x 44 x 4 mm 5.79" x 1.73" x 0.16"	P/GY								•			



P/B

BEIGE PARA: It is used for some front Dolly squeegees fitting Cleanfix. Para that we use has a thickness from 3 mm-0.12" to 10 mm-0.39" and a temp. resistance from -10 °C(50 °F) to +60 °C (140 °F).



PU/BL

BLUE POLYURETHANE (PU): It is used for front and back Dolly squeegees fitting Cleanfix. Polyurethane that we use has a thickness from 3 mm-0.12" to 8 mm-0.32" and a temp. resistance from -30°C(85 °F) to +70 °C (160 °F).

PU/M

BROWN POLYURETHANE (PU): It is used for front Dolly squeegees fitting Cleanfix. Polyurethane that we use has a thickness from 3 mm-0.12" to 8 mm-0.32" and a temp. resistance from -30°C(85 °F) to +70 °C (160 °F).



PU/G

GREEN POLYURETHANE (PU): It is used for some front and back Dolly squeegees fitting Cleanfix. Polyurethane that we use has a thickness from 3 mm-0.12" to 8 mm-0.32" and a temp. resistance from -30°C(85 °F) to +70 °C (160 °F).

<i>Dolly squeegees fitting:</i> CLEANFIX			Material	RA 400 E	RA 410 E	RA 410 B	RA 430 E	RA 430 B	RA 480 E	RA 480 B	RA 530 B	RA 560 B
Code	Description	Sizes L x H x P										
CDR.1098-I	Dolly squeegees - inside	455 x 32 x 3 17.93" x 1.26" x 0.12"	PU/BL	•	•	•						
CDR.1098-O	Dolly squeegees - outside	455 x 27 x 3 17.93" x 1.06" x 0.12"	PU/G	•	•	•						
CDR.1099-F	Dolly squeegees - front	725 x 46 x 3 mm 28.57" x 1.81" x 0.12"	PU/M				•	•				
CDR.1099-B	Dolly squeegees - back	725 x 46 x 3 mm 28.57" x 1.81" x 0.12"	PU/BL				•	•				
CDR.1100-F	Dolly squeegees - front	800 x 46 x 3 mm 31.52" x 1.81" x 0.12"	PU/M						•	•	•	•
CDR.1100-B	Dolly squeegees - back	800 x 46 x 3 mm 31.52" x 1.81" x 0.12"	P/B						•		•	
CDR.1101-B	Dolly squeegees - back	800 x 46 x 3 mm 31.52" x 1.81" x 0.12"	PU/BL							•		•



P/B

BEIGE PARA: It is used for some front and back Dolly squeegees fitting Hako. Para that we use has a thickness from 3 mm-0.12" to 10 mm-0.39" and temp. resistance from -10 °C(50 °F) to +60 °C (140 °F).



P/GY

GREEN POLYURETHANE (PU): It is used for some Dolly squeegees fitting Hako. Polyurethane that we use has a thickness from 3 mm-0.12" to 8 mm-0.32" and a temp. resistance from -30 °C(85 °F) to +70 °C (160 °F).



PU/G

BEIGE PARA: It is used for some support Dolly squeegees fitting Hako. Para that we use has a thickness from 3 mm-0.12" to 10 mm-0.39" and temp. resistance from -10 °C(50 °F) to +60 °C (140 °F).



PU/BL

BLUE POLYURETHANE (PU): It is used for front and back Dolly squeegees fitting Hako. Polyurethane that we use has a thickness from 3 mm-0.12" to 8 mm-0.32" and a temp. resistance from -30 °C(85 °F) to +70 °C (160 °F).

<i>Dolly squeegees fitting:</i> HAKO			Material	CLEAN 400 E	CLEAN 400 B	CLEAN 410 E	CLEAN 410 B	B 35	B 450-BM 54	B 450 POWERFLOW	B 530	B 550	B 650	E 35
Code	Description	Sizes L x H x P												
CDR.1068-I	Dolly squeegees - inside	455 x 27 x 3 mm 17.93" x 1.06" x 0.12"	PU/G	•	•	•	•	•						•
CDR.1068-O	Dolly squeegees - outside	455 x 27 x 3 mm 17.93" x 1.06" x 0.12"	PU/BL	•	•	•	•	•						•
CDR.1069-F	Dolly squeegees - front	950 x 50 x 5 mm 37.43" x 1.97" x 0.20"	P/B								•	•	•	
CDR.1069-B	Dolly squeegees - back	973 x 50 x 5 mm 37.43" x 1.97" x 0.20"	P/B								•	•	•	
CDR.1069-S	Dolly squeegees - support	973 x 40 x 4 mm 37.43" x 1.58" x 0.16"	P/GY								•	•	•	
CDR.1070-F	Dolly squeegees - front	862 x 51 x 5 mm 33.96" x 2.00" x 0.20"	P/B						•					
CDR.1070-B	Dolly squeegees - back	880 x 51 x 5 mm 34.67" x 2.00" x 0.20"	P/B						•					
CDR.1070-S	Dolly squeegees - support	890 x 41 x 4 mm 35.07" x 1.62" x 0.16"	P/GY						•					
CDR.1071-F	Dolly squeegees - front	755 x 50 x 5 mm 29.75" x 1.97" x 0.20"	P/B								•			
CDR.1071-B	Dolly squeegees - back	775 x 50 x 5 mm 30.53" x 1.97" x 0.20"	P/B								•			
CDR.1071-S	Dolly squeegees - support	770 x 41 x 4 mm 30.34" x 1.62" x 0.16"	P/GY								•			

Cleaning machines and equipment- Hotel cleaning equipment

**MADE
IN ITALY**

Chromed steel handle



Code	Working width	Weight	Description
CDR.0420	∅22 x 1450 mm ∅0.87" x 57.1"	gr. 620 oz. 21,9	Chromed steel handle. For articulated frames.

To remove dust



Code	Working width	Minimum quantity	Weight	Description
a) CDR.4087	60 cm 23.64"	1 pcs	gr. 890 oz. 31,5	a) Articulated frame, made of rubber lammellar bottom to dust/sweep floors with disposable impregnated gauzes. b) Disposable impregna- ted gauzes. Gauzes to remove dust from floors without lifting it.
b) CDR.4181	60 x 17 cm 23.64" x 6.7"	1000 pcs	gr. 155 oz. 5,5	
b) CDR.4182	60 x 20 cm 23.64" x 7.9"	1000 pcs	gr. 160 oz. 5,7	
b) CDR.4184	60 x 22 cm 23.64" x 8.7"	1000 pcs	gr. 160 oz. 5.7	
b) CDR.4183	60 x 30 cm 23.64" x 11.8"	1000 pcs	gr. 185 oz. 6.6	

To sweep / dust



Code	Working width	Weight	Description
CDR.4041	40 cm 15.76"	gr. 250	Articulated frames, (various sizes) for flat mops to sweep/dust.
CDR.4042	60 cm 23.64"	gr. 320	
CDR.4043	80 cm 31.52"	gr. 420	
CDR.4044	100 cm 39.40"	gr. 810	

Flat mops (cotton)



Code	Working width	Weight	Description
CDR.4131	40 cm 15.76"	gr. 180 oz. 6.4	Flat mops (cotton / white), (various sizes), with pocket to insert frame, to sweep/dust corridor floors.
CDR.4132	60 cm 23.64"	gr. 240 oz. 8.5	
CDR.4133	80 cm 31.52"	gr. 320 oz. 11.3	
CDR.4134	100 cm 39.40"	gr. 420 oz. 14.9	

Flat mops (acrylic)



Code	Working width	Weight	Description
CDR.4141	40 cm 15.76"	gr. 100 oz. 4.0	Flat mops (acrylic / blue), (various sizes), with pocket to insert frame, to sweep/dust corridor floors.
CDR.4142	60 cm 23.64"	gr. 150 oz. 5.3	
CDR.4143	80 cm 31.52"	gr. 190 oz. 6.7	
CDR.4144	100 cm 39.40"	gr. 250 oz. 8.9	